

**Isolation and Structure Elucidation of Bioactive
Secondary Metabolites from
Marine Sponges and Tunicates**

**(Isolierung und strukturelle Identifizierung von biologisch
aktiven Naturstoffen aus marinen Schwämmen und
Tunikaten)**

**Inaugural - Dissertation
zur
Erlangung des Doktorgrades
der Mathematisch-Naturwissenschaftlichen Fakultät
der Heinrich-Heine-Universität Düsseldorf**

**Vorgelegt von
Ziyad Baker
aus Düsseldorf, Deutschland**

Düsseldorf, 2004

Gedruckt mit Genehmigung der Mathematischen-Naturwissenschaftlichen Fakultät
der Heinrich-Heine Universität, Düsseldorf

Eingereicht am :

Referent : Prof. Dr. Peter Proksch
Koreferent : Prof. Dr. August-Wilhelm Alfermann

Tag der Prüfung : 12.07.2004

Erklärung

Hiermit erkläre ich ehrenwörtlich, daß ich die vorliegende Dissertation (Isolierung und strukturelle Identifizierung von biologisch aktiven Naturstoffen aus marinen Schwämmen und Tunikaten) selbständig angefertigt und keine anderen als die angegebenen Quellen und Hilfsmittel benutzt habe. Ich habe diese Dissertation in gleicher oder ähnlicher Form in keinem anderen Prüfungsverfahren vorgelegt.

Düsseldorf, 24.05.2004

Ziyad Nimer Baker

Acknowledgements

I wish to express my deep feeling of gratitude, great indebtedness and sincere appreciation to **Professor Dr. Peter Proksch**, my Doktorvater for giving me the chance of being involved in marine natural product and for his kind supervision, guidance, directions, comments, valuable support and revisions through the supervision and presentation of the thesis.

I am deeply indebted to grateful with deep sincere appreciation to **Professor Dr. Alfermann** for being the co-referent.

I am deeply indebted to grateful with deep sincere appreciation to **Dr. Rainer Ebel** for his continuous help and guidance especially in the interpretation of the NMR data of the isolated compounds.

I am deeply indebted and very grateful with deep sincere appreciation to **Dr. Ru Angelie Edrada** for her encouragement and unlimited help during the course of this work.

I would also wish to thank Dr. Wray for the measurement of the NMR spectra and his assistance in the interpretation of my data and also Dr. Peter (Institute für Anorganische und Strukturchemie) for NMR measurement in HHU Duesseldorf.

I would like to express my deep thanks to Dr. R. van Soest (Zoological Museum, Amsterdam) for the identification of the sponges.

I am greatly thankful to Dr. U. Matthiesen, Dr. Berg, Prof. Dr. Gräfe (HKI für Naturstoffforschung, Jena), and Dr. P. Tommes (HHU) for the mass spectral measurements.

I am greatly thankful to Dr. Lozach at CNRS Station Biologique (France) for doing the protein kinase screening assays for the brominated alkaloids.

I am greatly thankful to Dr. Klaus Passreiter for the beautiful time by the assistant in Pharmaceutical Biology II.

I am greatly thankful to Dr. Thomas Schmidt for his advice and help.

I would like to thank my colleague and brother **Mostafa Abdelgawwad** for his help and support during the work and for the excellent atmosphere that he was providing in the lab.

I would like to thank my colleague and sister Dr. Wafaa Hassan for the beautiful time.

I would to thank my lovely colleagues Franka Teuscher, Gero Eck, Sofia Lindgren, Nadine Weber, Bärbel Steffan, Carsten Thoms and Arnulf Diesel for everything and especially for the (Carnival time).

I would like to thank my colleague and sister Amal Hassan for her help in the revision of this thesis and for the nice time which we spent together.

I would like to thank my Arabic colleagues Mohammed Ashour, Sabrin Ibrahim, Amal Nur, Ehab El-khayat, Manal and Gamal.

I would to thank the secretariat Ms. Marieke Thiel, and the technical assistants Katrin, Katja and Frau Schlag.

.I would to thank Dr. Hefni Effendi and other colleagues like Yasman, Yosi, Ine and Yudi.

Special debt of gratitude and deepest thank to my brother Gehad Nimer and his wife Nagham Dirbas for their encouragement.

Finally grateful thank to my family and to all who contributed by one way or another for the realisation of the present work.

To the memory of my father Nimer Baker

To my mother Adila Qasem

To my people in Palestine

Table of contents

Acknowledgements	iv
Table of contents	vii
Zusammenfassung	x
1. INTRODUCTION.....	1
1.1 Significance of the study.....	1
1.2 Construction and introduction of sponges.....	3
1.3 The importance of bioactive marine natural products.....	7
1.3.2 Cytotoxic and anti-cancer marine natural products	8
1.3.3 Anti-inflammatory marine natural products.	9
1.3.4 Antiviral and anti-toxoplasmosis marine natural products	10
1.3.5 Role of symbiotic microorganisms in the biosynthesis of sponge metabolites	12
1.4 The aim of the present work	13
2. Materials and Methods.....	14
2.1 Biological materials.....	14
2.1.1 <i>Stylissa carteri</i>	15
2.1.2 <i>Diacarnus megaspinorhabdosa</i>	16
2.1.3 <i>Fascaplysinopsis reticulata</i>	17
2.1.4 <i>Tunicate Lissoclinum patella</i>	18
2.1.5 <i>Hyrtios reticulatus</i>	19
2.2 Chemicals used.....	20
2.2.1 General laboratory chemicals	20
2.2.2 Solvents.....	20
2.2.3 Chromatography	21
2.3 Equipments used.....	21
2.3.1 HPLC equipment	22
2.3.2 Preparative HPLC	22
2.4 Chromatographic methods	23
2.4.1 Thin layer chromatography.....	23
2.4.2 Column chromatography	23
2.4.3 Semi-preparative HPLC.....	24
2.4.4 Preparative HPLC	25
2.4.5 Analytical HPLC.....	25
2.4.6 Vacuum liquid chromatography	25

2.5 Procedure for the isolation of secondary metabolites.....	27
2.5.1 Isolation of secondary metabolites from <i>Stylissa carteri</i>	27
2.5.2 Isolation of secondary metabolites from <i>Diacarnus megaspinothabdosus</i>	28
2.5.3 Isolation of secondary metabolites from <i>Fascaplysinopsis reticulata</i>	29
2.5.4 Isolation of secondary metabolites from Tunicate <i>Lissoclinum patella</i>	30
2.5.5 Isolation of secondary metabolites from <i>Hyrtios reticulatus</i>	31
2.6 Structure elucidation of the isolated compounds.....	32
2.6.1 Mass spectrometry (MS).....	32
2.6.2 Nuclear magnetic resonance spectroscopy (NMR).....	33
2.7 Bioassay.....	34
2.7.1. Antimicrobial activity	34
2.7.2 Cytotoxicity test.. ..	35
2.7.3 Protein kinase screening assays	35
2.7.4 Fish-feeding assay.....	37
3. Results	40
3.1 Isolation and structure elucidation of the secondary metabolites from <i>Stylissa carteri</i>.....	40
3.1.1 Structure elucidation of aldisin [01].	43
3.1.2 Structure elucidation of 2-bromoaldisin [02].....	47
3.1.3 Structure elucidation of 2,3-bromoaldisin [03].....	51
3.1.4 Structure elucidation of Z-debromohymenialdisin [04].....	55
3.1.5 Structure elucidation of Z-hymenialdisin [05].....	59
3.1.6 Structure elucidation of 3-bromohymenialdisin [6].....	62
3.1.7 Structure elucidation of hymenidin [07].	65
3.1.8 Structure elucidation of 4, 5 dibromopyrrole-2-carbamide [08].....	69
3.1.9. The results of biological assays	70
3.1.9.1 Protein kinase inhibition test.....	70
3.2 Indole alkaloids and nucleosides from sponge <i>Diacarnus megaspinothabdosus</i>.....	71
3.2.1 Structure elucidation of indole-3-carbaldehyde [09].	74
3.2.2 Structure elucidation of Indole-3-carboxylic acid [10].....	77
3.2.3 Structure elucidation of Adenosine [11].	80
3.2.4 Structure elucidation of 2'-deoxyadenosine [12].....	83
3.2.5 Structure elucidation of 2-deoxythymidine [13].....	87
3.3 Tryptophan derivatives from the sponge <i>Fascaplysinopsis reticulata</i>.....	91
3.3.1 Structure elucidation of 7-methyl-6-methylamino-7, 9-dihydro-purin-8-one [14]..	94
3.3.2 Structure elucidation of 6-dimethylaminopurine [15]	98
3.3.3 Structure elucidation of 2-(6-bromo-1-methyl-1H-indol-3-yl)-acetamide [16] ..	101
3.3.4 Structure elucidation of E/Z-aplysinopsin [17-18]	105
3.3.5 Structure elucidation of 6-bromoaplysinopsin [19]	111
3.3.6 Structure elucidation of 6-bromo-3'-deimino-3-oxoaplysinopsin [20-21]	115
3.3.7 Results of biological assays	118
3.3.7.1 Protein kinase inhibition test.....	118
3.3.7.2 Cytotoxicity test	118

3.4 Cyclic peptides from the tunicate <i>Lissoclinum patella</i>	119
3.4.1 Structure elucidation of Preulicyclamide [22]	122
3.4.2 Structure elucidation of Prelissoclinamide-2 [23]	129
3.4.3 Structure elucidation of Lissoclinamide-10 [24].	134
3.4.4 Structure elucidation of Lissoclinamide 2 and Ulicyclamide [25-26].	139
3.5 β-Carboline derivates from the marine sponge <i>Hyrtios reticulatus</i>	146
3.5.1 Structure elucidation of 6-hydroxy-2,9-dihydro- β -carbolin-1-one[27] (new).....	149
3.5.2 Structure elucidation of 6-hydroxy-3,4-dihydro-1-oxo- β -carboline [28]	155
3.5.3 Structure elucidation of 9H- β -carboline-4,6-diol [29] (new).	161
3.5.4 Cytotoxicity test.....	165
4. Discussion	166
4.1 Bromopyrrole alkaloids from marine sponges	167
4.1.1 Bromopyrrole alkaloids from the sponge <i>Stylissa carteri</i>	167
4.2 Imidazole alkaloids from marine sponges	169
4.2.1 Imidazole alkaloids from the sponge <i>Fascaplysinopsis reticulata</i>	170
4.2.2 Explanation of the E/Z-aplysinopsin photoisomerization.....	171
4.3 β-Carboline alkaloids from marine animals	172
4.3.1 Structure-activity relationship of β -carbolines.....	173
4.4 Cyclic peptides isolated from the tunicate <i>Lissoclinum patella</i>	174
4.4.1 Metal binding to cyclic peptides	175
4.4.2 Structure-activity relationship of peptides	175
5. Summary	176
5.1 The Red Sea sponge <i>Stylissa carteri</i>	176
5.2 The Indonesian sponge <i>Diacarnus megaspinorhabdosa</i>	176
5.3. The Indonesian sponge <i>Fascaplysinopsis reticulata</i>	176
5.4 The Indonesian tunicate <i>Lissoclinum patella</i>	177
5.5 The Indonesian sponge <i>Hyrtios reticulatus</i>	177
6. References	178

Zusammenfassung

Marine Organismen wie Schwämme, Tunikaten und Korallen erzeugen eine erstaunliche Anzahl wichtiger, biologisch aktiver Verbindungen. Viele davon zeigen potente Aktivität gegen Krebszelllinien und andere Krankheiten. Daher wurde in den letzten 50 Jahren eine intensive Forschung nach neuen und stärker wirksamen Substanzen betrieben, um Krankheiten zu heilen und das marine Ökosystem besser zu verstehen.

In dieser Arbeit wurden marine Organismen - vier Schwämme und ein Tunikat – aus dem Roten Meer (Jordanien) und Indonesien erforscht. Unter Anwendung verschiedener chromatographischer Verfahren wurden 31 Metabolite isoliert. Die Strukturen der Verbindungen wurden auf Grundlage von NMR- und massenspektrometrischen Daten aufgeklärt.

1. Der Schwamm *Stylissa carteri* (Rotes Meer)

Aus dem Schwamm *Stylissa carteri* wurden acht brominierte Alkaloide, davon ein neues Alkaloid isoliert [03]. Die interessanteste Verbindung ist das bereits bekannte Z-Hymenialdisin **05**, dessen Wirkung als potenter Inhibitor der mitogen-aktivierten Proteinkinase-1 (MEK-1) ($IC_{50}=6nM$) kürzlich beschrieben wurde (Eder *et al.*, 1999).

2. Der Schwamm *Diacarnus megaspinorhabdosa* (Indonesien)

Der Schwamm *Diacarnus megaspinorhabdosa* wurde mehrmals mit MeOH und Aceton extrahiert. Dieser Extrakt wurde bis zum Trockenen eingeengt und mit Petrolether, EtOAc sowie *n*-BuOH gegen Wasser ausgeschüttelt. Die *n*-BuOH und EtOAc-Fractionen wurden einer Säulenchromatographie, gefolgt von einer semipräparativen HPLC unterzogen, wobei fünf bereits bekannte Verbindungen einschließlich zwei Indolalkaloide und drei Nukleoside isoliert wurden.

3. Der Schwamm *Fascaplysinopsis reticulatus* (Indonesien)

Aus dem Schwamm *Fascaplysinopsis reticulatus* wurden sechs Alkaloide aus der Gruppe der Hydantoin (= Imidazolidin-2,4-dion)-Derivate gewonnen, darunter zwei neue Alkaloide [17] und [18]. Andere Metabolite dieses Schwammes zeigen starke Zytotoxizität gegen Krebszelllinien (L518y, Hela und PC). Auch über die signifikante Aktivität dieser Verbindungen gegen Filarialparasiten wurde berichtet (Singh *et al.*, 1997).

4. Der Tunikat *Lissoclinum patella* (Indonesien)

Der Tunikat wurde mit MeOH und dann mit Aceton extrahiert, das Lösungsmittel unter vermindertem Druck entfernt. Der Rohextrakt wurde mit EtOAc gegen Wasser ausgeschüttelt. Die EtOAc-Fraktion wurde einer VLC unter Verwendung eines Gradienten von 100% Dichlormethan nach 100% MeOH unterzogen, hierbei wurden mehrere Fraktionen erhalten. Eine dieser Fraktionen wurde einer Säulenchromatographie, gefolgt von semipräparativer HPLC unterzogen, wobei fünf bekannte zyklische Peptide isoliert wurden. Von einigen dieser Peptide ist bekannt, dass sie Multiresistenzen in CEM/VL₁₀₀ Zellen hemmen (Fu. *et al.*, 1998).

5. Der Schwamm *Hyrtios reticulatus* (Indonesien)

Der Schwamm wurde mit MeOH und Aceton extrahiert, das Lösungsmittel unter reduziertem Druck entfernt. Die vereinigten Rohextrakte wurden mit EtOAc gegen Wasser ausgeschüttelt. Die EtOAc-Fraktion wurde dann einer VLC unter Verwendung eines Gradienten von 100% Dichlormethan nach 100% MeOH unterzogen, wobei mehrere Fraktionen erhalten wurden. Eine Fraktion wurde einer Säulenchromatographie, gefolgt von semipräparativer HPLC und präparativer HPLC unterzogen. Hierbei wurden drei Alkaloidderivate isoliert, darunter zwei neue β -Carbolinderivate **27** and **29**, die moderate Zytotoxizität gegen Krebszelllinien (L518y-8000/ μ l) zeigen.

1. INTRODUCTION

1.1 Significance of the study

Marine natural products chemistry has experienced explosive growth over the past fifty years beginning with Werner Bergmann's pioneer work in the 1950's (Bergmann and Feeney, 1951), who isolated three nucleosides: spongouridine, spongothymidine and spongosine from the Caribbean sponge *Cryptotethia crpta* Laubenfels. These compounds have been a model for developing the synthesised antiviral Ara-A (see Figure 1.1.A). Ocean biodiversity began to be appreciated from the beginning of the last century and estimates of the species number range from 1.5 to 4.5 million species.

Since this pioneering work, a number of structurally original and biologically active compounds have been discovered from sponges, many of them with potential application as anticancer agents. In order to evaluate the biomedical potential of any plant or animal, one must consider both the chemical ecology of the organism and its evolutionary history. It is probable that chemical defence mechanisms evolved with the most primitive micro-organisms but have been replaced in many more advanced organisms by physical defence and /or the ability to run or swim away and hide. Sessile, soft-bodied marine invertebrates that lack obvious physical defence are therefore prime candidates to possess bio-active metabolites. If it is assumed that secondary metabolites are produced at random, any newly produced secondary metabolite that offers an evolutionary advantage to the producing organism would contribute to the survival of the new strain. The specific evolutionary pressures that led to chemically rich organisms need not be defined but the longer the period of evolution, the more time the surviving organism has had to perfect its chemical arsenal. Sessile marine invertebrates have a very long evolutionary history and have had ample opportunity to perfect their chemical defence. Among the many phyla found in the oceans, the best sources of pharmacologically active compounds are bacteria (including cyanobacteria), fungi, certain groups of algae, sponges, soft corals, gorgonians, sea hares and nudibranchs, bryozoans and tunicates.

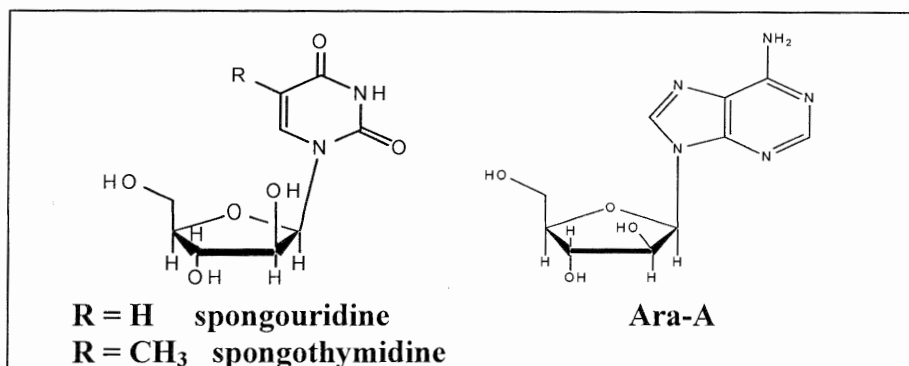
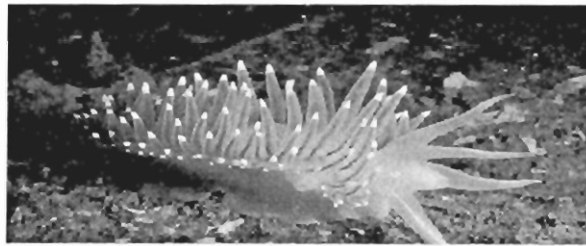
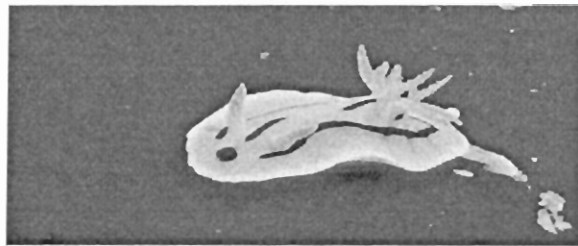

Figure 1.1.A: Nucleoside derivatives

Introduction



Sponges



Nudibranchs



Bryozoans

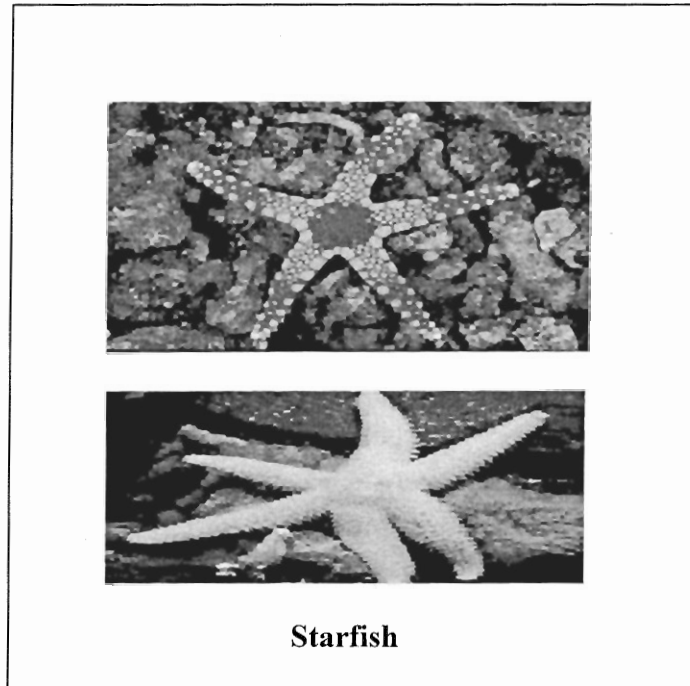

1.2 Construction and introduction of sponges

Under the different groups of marine invertebrates and algae, the sponges turned out as one of the most productive and most interesting sources of natural substances in the last 30 years regarding their contents. Sponges are organisms, which are provable for several hundred million years on earth (Proksch, 1994).

Sponges (poriferans) are very simple animals that live permanently attached to a location in the water - they are sessile (permanently attached to a substrate and unable to move on its own) as adults. There are from 5,000 to 10,000 known species of sponges. Most sponges live in salt water - only about 150 species live in fresh water. Sponges evolved over 500 million years ago.

The body of this primitive animal has thousands of pores which let water flow through it continually. Sponges obtain nourishment and oxygen from this flowing water. The flowing water also carries out waste products.

Introduction

Anatomy: The body of a sponge has two outer layers separated by an acellular (having no cells) gel layer. In the gel layer are either spicules (supportive needles made of calcium carbonate) or spongin fibers (a flexible skeletal material made from protein). Sponges have neither tissues nor organs. Different sponges form different shapes, including tubes, fans, cups, cones, blobs, barrels and crusts. These invertebrates range in size from a few millimeters to 2 meters tall (see Figure 1.2.A)

Diet: Most sponges eat tiny, floating organic particles and plankton that they filter from the water that flows through their body.

Reproduction: Most sponges are hermaphrodites (each adult can act as either female or male in reproduction). Fertilization is internal in most species; some release sperms that randomly float to another sponge with the water current. If a sperm is caught by another sponge's collar cells (choanocytes), fertilization of an egg by the travelling sperm takes place. The resulting tiny larva is released and is free-swimming; it uses tiny cilia (hairs) to propel itself through the water. The larva eventually settles on the sea floor, becomes sessile and grows into an adult. Some sponges also reproduce asexually; fragments of their body (buds) are broken off by water currents and carried to another location, where the sponge will grow.

Classification: Kingdom Animalia (animals), Phylum Porifera (sponges), Classes: Calcarea (calcerous sponges - having spicules), Demospongiae (horn sponges, like the bath sponge), Scleropongiae (coralline or tropical reef sponges) and Hexactinellida (glass sponges).

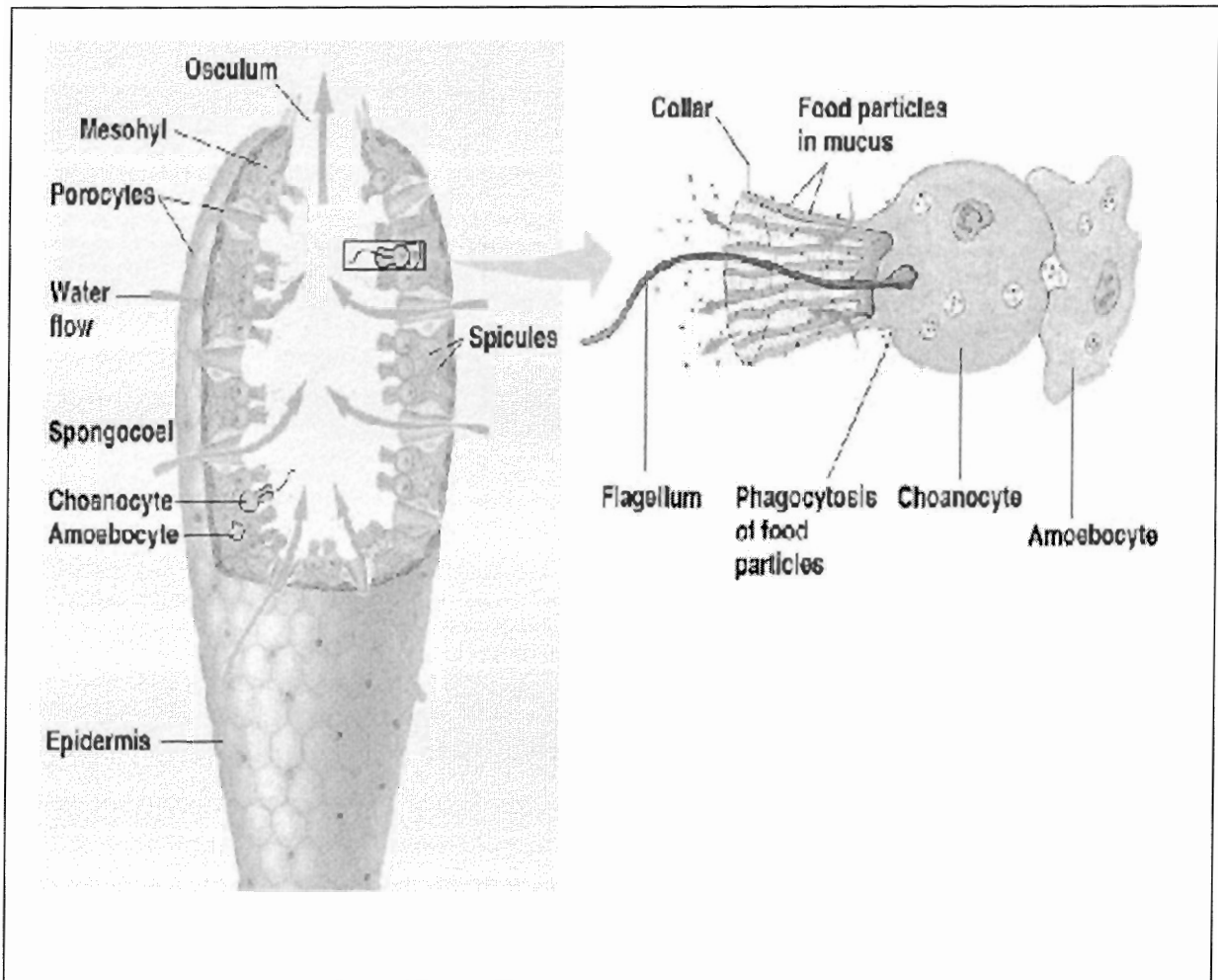

Figure 1.2.A: Anatomy of the sponge

archaeocyte (amoebocyte) - Cells with pseudopods, located in the mesohyl. They are used in processing food, distributing it to other cells and for other functions.

choanocyte - Also called the collar cell, these cells line the inner cavity of the sponge and have a flagellum. The sponge obtains its nutrients and oxygen by processing flowing water using-choanocytes.

epidermis (pinacocyte) - The epidermis is the layer of cells that covers the outer surface of the sponge. The thin, flattened cells of the epidermis are called pinacocytes.

flagellum - The whip-like structure of a choanocyte; the flagellum moves, pushing water (which contains nourishment) through the sponge.

mesohyl (mesenchyme) - The gelatinous layer between the outer body of the sponge and the spongocoel (the inner cavity).

Introduction

spicule – (see Figure 1.2.1.B) spicules are sharp spikes (made of calcium carbonate) located in the mesohyl. Spicules form the "skeleton" of many sponges.

spongocoel - the central, open cavity in a sponge through which water flows.

water flows in through porocytes - water flows into a sponge through cells with pores (these cells are called porocytes) located all over its body.

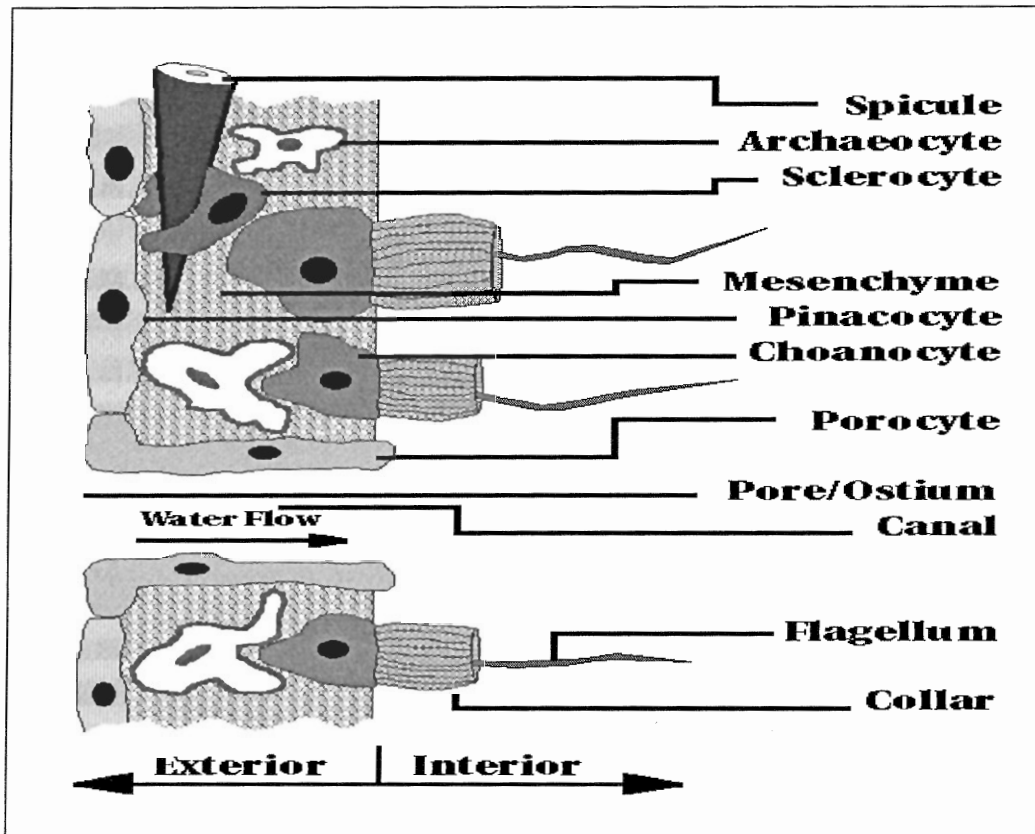

Figure 1.2.1.B: Microscopic view of the sponge wall

1.3 The importance of bioactive marine natural products

Approximately half of all marine natural products papers report bioactivity data for new compounds. This reflects both the fact that much of the funding for marine natural products chemistry originates from health science agencies and that many soft-bodied marine invertebrates produce bioactive compounds as elements of a chemical defence mechanism. New chemical compounds from marine sources are not only useful to the organisms which produce them, but also as resources in the search for new cures for cancer, Aids, arthritis, etc. New compounds are routinely tested in screens for activities against these diseases.

1.3.1 Antimalarial marine natural products

Antimalarial chemotherapy has become more complex and challenging because of multidrug resistant strains of *Plasmodium falciparum*. Due to resistance of malarial parasites against well known drugs (quinoline alkaloids, iso-quinoline alkaloids, indoloquinoline alkaloids, carbolines, bisisoquinoline and 4-quinazole derivatives), the chemotherapy of malaria has become complicated. Malaria affects more than 2,400 million people, over 40% of the world's population, in more than 100 countries in the tropics from South America to the Indian peninsula (see Figure 1.3.1.A). The tropics provide ideal breeding and living conditions for the Anopheles mosquito and hence this distribution. About 1.5 million to 3 million people die from malaria every year (85% of these occur in Africa), accounting for about 4-5% of all fatalities in the world. One child dies from malaria somewhere in Africa every 20 sec. and there is one malarial death every 12 sec. somewhere in the world.

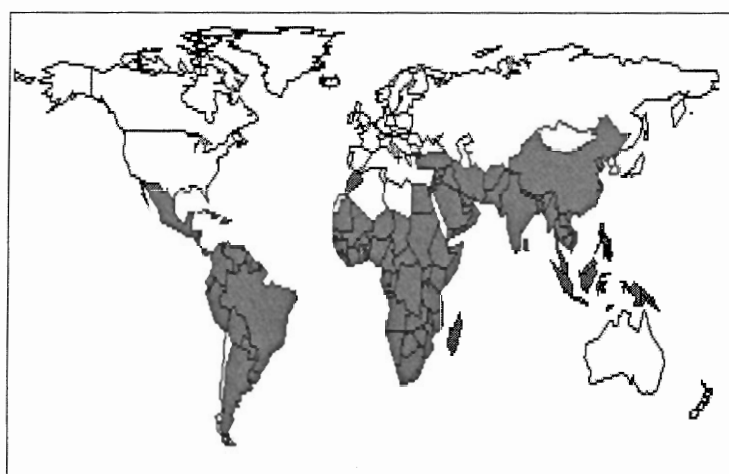

Fig. 1.3.1.A: Geographic distribution of malaria

Manzamines, manzamines are complex alkaloids isolated from marine sponges. Since the first report of manzamine A in 1986, some 40 related compounds have been described from more than a dozen species of sponges. Manzamine A (see Figure 1.3.1.B) was initially described as a cytotoxic compound exhibiting IC_{50} of $0.07 \mu\text{g/ml}$ against P388 mouse leukaemia cells. The unique structure of the manzamines has attracted a number of synthetic chemists to challenge total synthesis.

More recently, manzamine A was shown to have *in vivo* potent antimalarial activity in an assay against rodent malaria parasite *Plasmodium berghei* (Higa *et al.*, 2001).

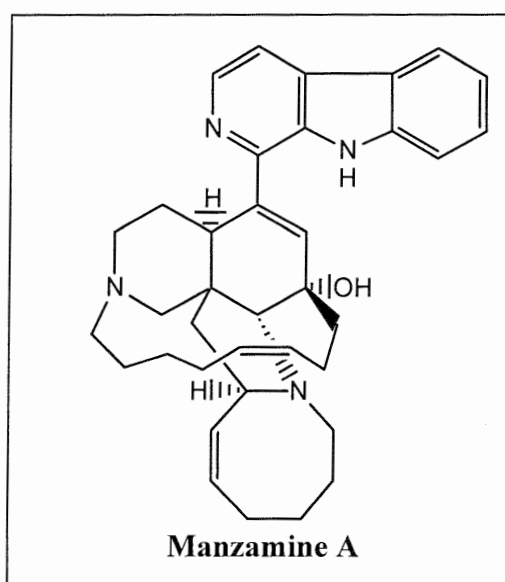

Figure 1.3.1.B: Antimalaria metabolite

1.3.2 Cytotoxic and anti-cancer marine natural products

A lot of drugs, isolated from the marine environment, show anti-cancer activity (see Table 1.3.2.A), such as microtubule-stabilizing agents, that disrupt the formation and maintenance of microtubules in cells thus suppressing cell division. Hence, these compounds are of particular interest. This interest has been engendered by the clinical success of the drug taxol (R), from the plant (*Taxus x media*) that is similar in action to the marine natural product laulimalide (see Figure 1.3.2.A). The drug is effective in the treatment of breast and ovarian cancers. However, some cancer cells and other forms of cancer have proved to be resistant to taxol, prompting the development of other agents showing the same mode of action. Recently, the Okinawan Ocean sponge *Fasciospongia rimosa* discovered by University of Hawaii researchers, has been found to produce a potent microtubule stabilizing agent. Laulimalide,

named for the Hawaiian word "laulima", "to work together", works in a manner similar to the structurally unrelated compound taxol, but appears to be more effective. It is a potent killer of cancer cells and may have advantages over taxol in that it retains activity against cancer cells that are resistant to taxol (R). Although laulimalide is only one-fifth as potent as taxol in drug-sensitive laboratory cell lines, it is as much as 100 times more potent than taxol in multi-drug-resistant cell lines. Laulimalide has become a high profile target for synthetic efforts on an international level with ten groups now working towards its total synthesis (Faulkner, 2000).

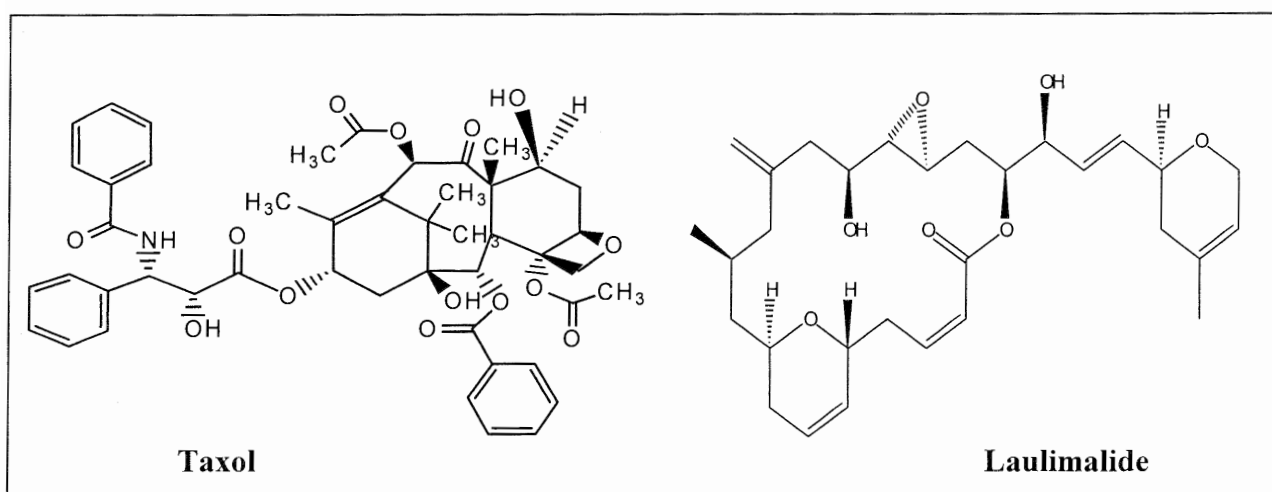

Figure 1.3.2.A: Anticancer metabolites

1.3.3 Anti-inflammatory marine natural products.

Manoalide (see Figure 1.3.3.A), which was isolated from the Palauan sponge *Luffariella variabilis* (de Silva and Scheuer, 1980) was found to irreversibly inhibit the release of arachidonic acid from membrane phospholipids by the enzyme phospholipase A2 (PLA2), thus inhibiting inflammation (Glaser and Jacobs, 1986, 1987). It was shown that the pharmacophore of manoalide contains two masked aldehyde groups (hemiacetals) that react with lysine residues on the interfacial binding site of PLA2. Moreover, manoalide exercised its inhibitory properties by preventing the enzyme from binding to membranes rather than blocking the active site of PLA2 (Glaser *et al.*, 1989; Ortiz *et al.*, 1993; Potts *et al.* 1992 a, b). Manoalide was patented by the University of California and licensed to Allergan Pharmaceuticals, which took the natural product through to Phase I clinical trials for the treatment of psoriasis. Allergan and several other companies have used manoalide as the starting point for medicinal chemistry programs, but to date no drug that is obviously based on manoalide has reached the market (Faulkner, 2000).

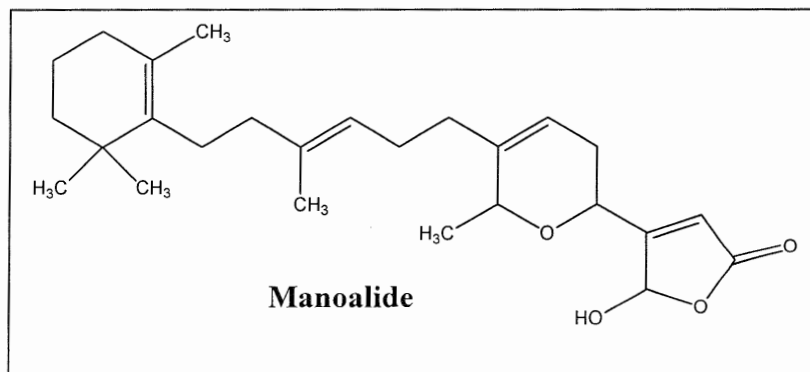

Figure 1.3.3.A: Anti-inflammatory metabolite

1.3.4 Antiviral and anti-toxoplasmosis marine natural products

Muqubilin (see Figure 1.3.4.A) was isolated from the Red Sea sponge *Diacarnus erythraenus*. Muqubilin showed *in vitro* antiviral activity against Herpes simplex type 1 (HSV-1) with ED₅₀ values of 7.5 and 30 µg/mL, respectively. Muqubilin and sigmosceptrellin-B displayed potent *in vitro* activity against *Toxoplasma gondii* at a concentration of 0.1µM without significant toxicity (Newman, 1999).

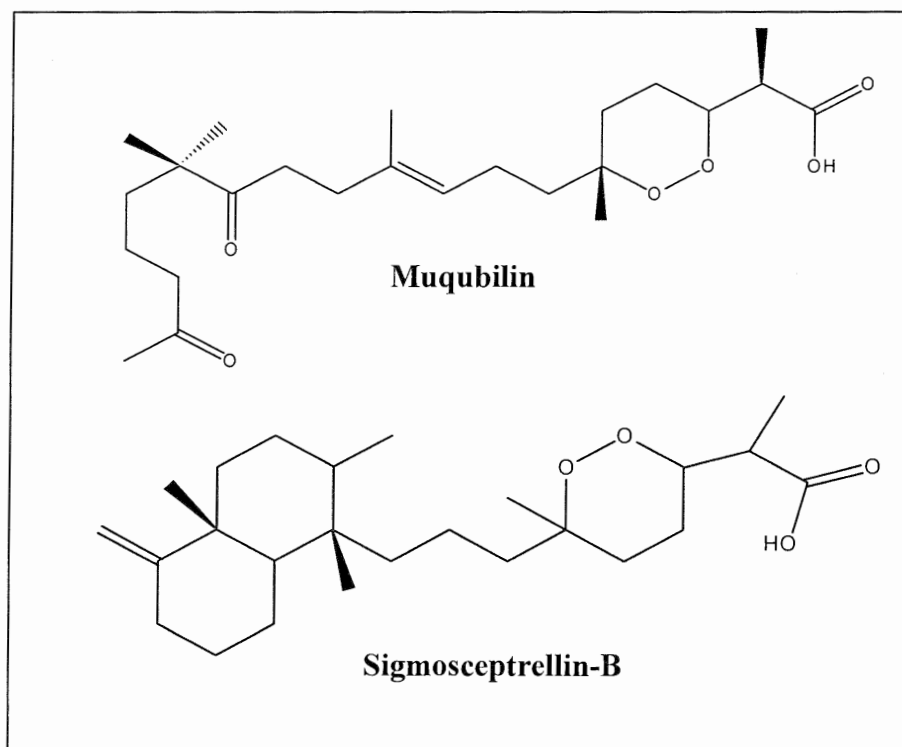

Figure 1.3.4.A: Antiviral and anti- toxoplasmosis metabolites

Table 1.3.2.1: The current status of antitumor pharmacology marine natural product research (Alejandro M.S., 1998)

Compound	Organism	Chemistry	Experimental or clinical model	Mechanism of action	Country
Ascididemin	Tunicate	Alkaloid	Human and murine leukemia cell lines	Induction of apoptosis; no effect on topoisomerase I and II	France
Bryostatin-1	Bryozoa	Macrolide	Murine <i>in vivo</i> tumor model	Paclitaxel-bryostatin combination is sequence-dependent	United States
Cryptophycins	Bacteria	Depsipeptide	Bovine brain tubulin	Tight noncovalent binding to a tubulin high-affinity site	United States
Didemnin B	Tunicate	Depsipeptide	Rabbit reticulocyte lysate and human adenocarcinoma cell line	Intact depsipeptide ring required for protein synthesis inhibition	United States
Discodermolide	Sponge	Polyketide	Human and murine tumor cell lines	Apoptosis as a potential mechanism of synergy with paclitaxel	United States
Ecteinascidin-743	Tunicate	Isoquinoline alkaloid	Human colon carcinoma cell line	Inhibition of human P glycoprotein gene (MDR1) transcription	United States
Ecteinascidin-743	Tunicate	Isoquinoline alkaloid	Molecular dynamics	Minor groove widening and bending towards major groove and putative protein-DNA interactions	Spain
Eleutherobin analogues	Coral	Diterpene glycoside	Human breast carcinoma cell line	Eleutherobin pharmacophore B region necessary for tubulin binding	Canada, Brazil, the Netherlands
Fascaplysin	Sponge	Alkaloid	Human colon carcinoma and osteogenic sarcoma cell lines and normal fibroblasts	Cyclin-dependent kinase 4 inhibition	Switzerland
Indanone from <i>Lyngbya majuscula</i>	Bacteria	Polyketide	Human hepatocellular carcinoma cell line	VEGF expression inhibition	United States
Jaspamide	Sponge	Depsipeptide	Human	Induction of polyploidization	Japan

1.3.5 Role of symbiotic microorganisms in the biosynthesis of sponge metabolites

Marine plants and animals are well known to have developed highly specific relationships with numerous microorganisms (Jensen and Fenical, 1994). Sponges, perhaps to a greater extent than any other marine invertebrates, harbor extraneous organisms on their surfaces, in their canal systems and in the intercellular matrix which constitutes a large part of the body. The volume of bacteria in some species can reach 40% of the total cellular content (Vacelet and Donadey, 1977; Wilkinson, 1978).

The question of the role of these microorganisms in the synthesis of compounds of biological interest is currently the subject of intensive research efforts.

Dysidea herbacea is a common shallow-water sponge which has been extensively studied (Keller, 1889). All samples contain terpenoids and either polychlorinated or polybrominated compounds, but not both (Unson *et al.*, 1994). The dominant endosymbiont is the filamentous cyanobacterium *Oscillatoria spongelliae* (Schulze, 1892), but heterotrophic bacteria are also present. The flow-cytometric separation of the symbionts from the sponge cells showed that chlorinated metabolites such as 13-demethylisodysidenin (see Figure 1.3.5.A) are located in the cyanobacterial filaments (Unson and Faulkner, 1993). Another study revealed that the bromophenylether -1 also occurs exclusively in the cyanobacteria.

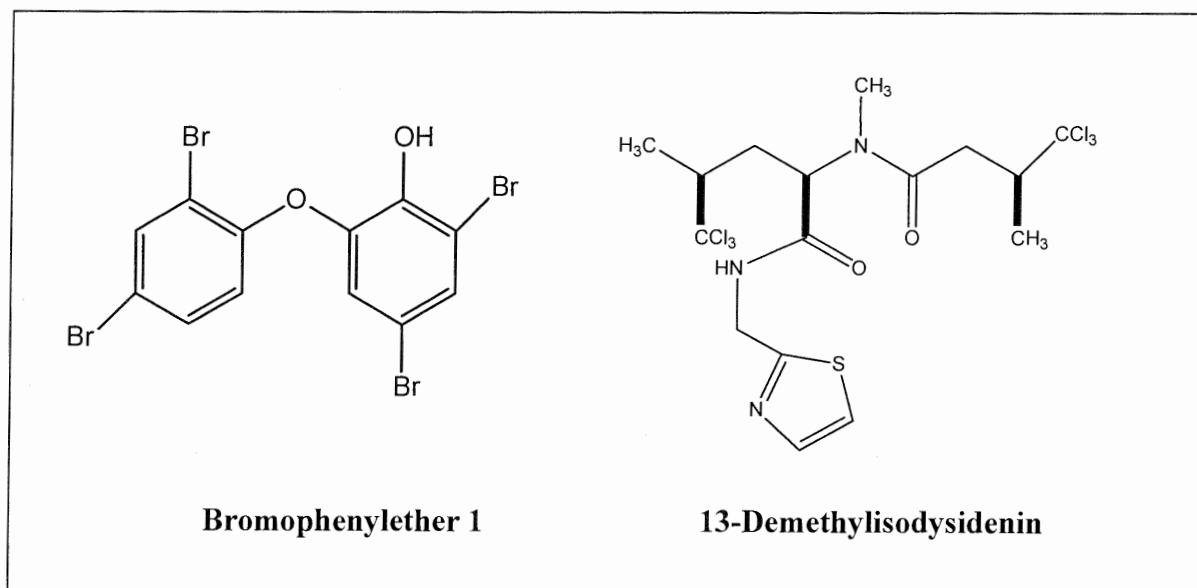

Figure 1.3.5.A: Structures of compounds isolated from microorganisms

1.4 The aim of the present work

Looking for new substances from marine organisms (especially sponges) that are of benefit in medicine and in therapy of harmful diseases such as cancer, malaria, Aids, etc., has importance in the current time.

In the present work biologically active natural substances from marine invertebrates from the Red Sea (Aqaba) and from Indonesia, with emphasis on sponges and tunicates, have been investigated. The aim of this investigation was the finding of biologically active natural products that could be possibly serve as lead structures for the development of new drugs or plant protection agents.

For the main part of this work different chromatographic techniques like TLC, CC, VLC and semi-preparative HPLC were used to isolate the most biologically interesting compounds. Different methods of NMR-spectroscopy (^1H -NMR, ^{13}C -NMR, DEPT, COSY, ROESY, NOESY and NOE) and mass-spectroscopy were used for structure elucidation.

Most of the isolated compounds were screened for antibiotic, cytotoxic and protein kinase inhibitory activities.

2. Materials and Methods

2.1 Biological materials

Samples including sponges and tunicates were collected from the Gulf of Aqaba, Red Sea (Jordan) (see Figure 2.1.A) or from the Kudingarengkeke, Langkai and Baranglombo islands in Indonesia (see Figure 2.1.B). The sponges were collected by scuba or drop-off diving and vouchers of specimens were identified by Dr. Rob W. M. van Soest of the Zoological Museum, Amsterdam. The samples were frozen at -20°C until work up. The freeze-dried samples were extracted with organic solvents and the resulting extracts were subjected to a series of biological assays for cytotoxicity, fungicidal, antiviral and antibiotic activity.



Figure 2.1.A: Map of Jordania



Figure 2.1.B: Map of Indonesia

2.1.1 *Stylissa carteri*

Phylum	:	Porifera
Class	:	Demospongia
Order	:	Axinellida
Family	:	Axinellidae
Genus	:	<i>Stylissa</i>
Species	:	<i>Stylissa carteri</i>

The sponge *Stylissa carteri* (see Figure 2.1.1) was collected by Mr. Khaleed Trabeen from the marine station of Gulf of Aqaba (Jordan) in 2000. This sponge is a morphologically variable kind. In the chemical literature it emerges under the name *Acanthella carteri*, *Acanthella aurantiaca*, *Axinella carteri* and *Stylissa carteri*. *S. carteri* was described for the first time by Dendy (1889).

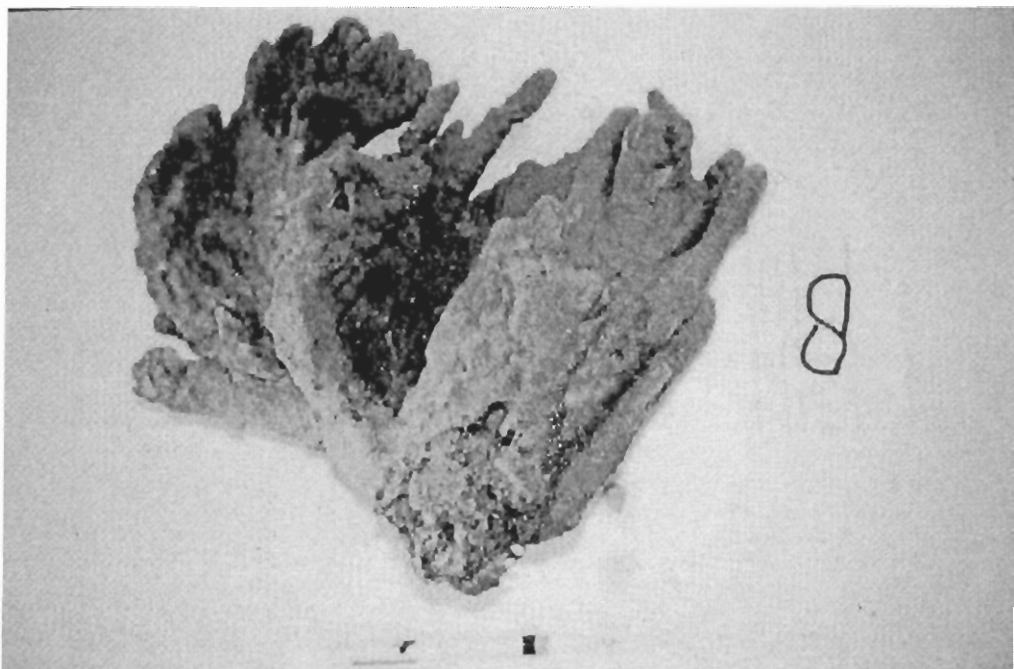

Figure 2.1.1: *Stylissa carteri*, this picture was taken from the thesis of (Supriyono, 1997)

2.1.2 *Diacarnus megaspinorhabdosa*

Phylum	:	Porifera
Class	:	Demospongia
Order	:	Hadromerida
Family	:	Latrunculiidae
Genus	:	<i>Diacarnus</i>
Species	:	<i>Diacarnus megaspinorhabdosa</i>

The sponge *Diacarnus megaspinorhabdosa* (see Figure 2.1.2) was collected from Kudingarengkeke Island in Indonesia. It was collected in the year 1997 at a depth of 22 ft. A voucher specimen has been deposited in the Zoological Museum, Amsterdam, under registration number ZMA POR. 17057.

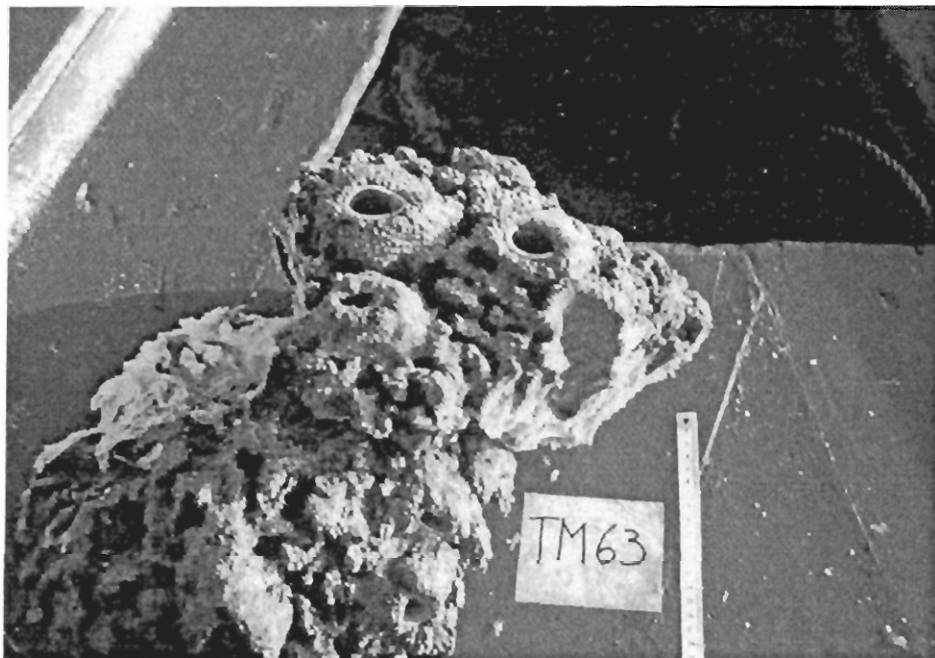

Figure 2.1.2: *Diacarnus megaspinorhabdosa*

2.1.3 *Fascaplysinopsis reticulata*

Phylum	:	Porifera
Class	:	Demospongia
Order	:	Verongida
Family	:	Aplysinidae
Genus	:	<i>Fascaplysinopsis</i>
Species	:	<i>Fascaplysinopsis reticulata</i>

The sponge *Fascaplysinopsis reticulata* (see Figure 2.1.3) was collected from Langkai Island in Indonesia. It is a fissured surface sponge with many oscula, rubber-like, softly, inside lemon-yellow and outside black. It was collected in the year 1997 at a depth of 32 ft. A voucher specimen has been deposited in the Zoological Museum, Amsterdam, under registration number ZMA POR. 17165.



Figure 2.1.3: *Fascaplysinopsis reticulata*

2.1.4 Tunicate *Lissoclinum patella*

Phylum	:	Chordata
Class	:	Ascidiacea
Order	:	Enterogona
Family	:	Didemnidae
Genus	:	<i>Lissoclinum</i>
Species	:	<i>Lissoclinum patella</i>

The tunicates are commonly called sea squirts because many species expel streams of water through a siphon. They are members of the phylum Chordata; subclass Urochordata. The tunicates are unique among chordates in several aspects: they are exclusively marine organisms that are predominantly but not exclusively benthic sessile species. The tunicates have proven to be a rich source of bioactive secondary metabolites. The tunicate *Lissoclinum patella* (see Figure 2.1.4) was collected in year the 1997 from Langkai Island in Indonesia at a depth of 48 ft.

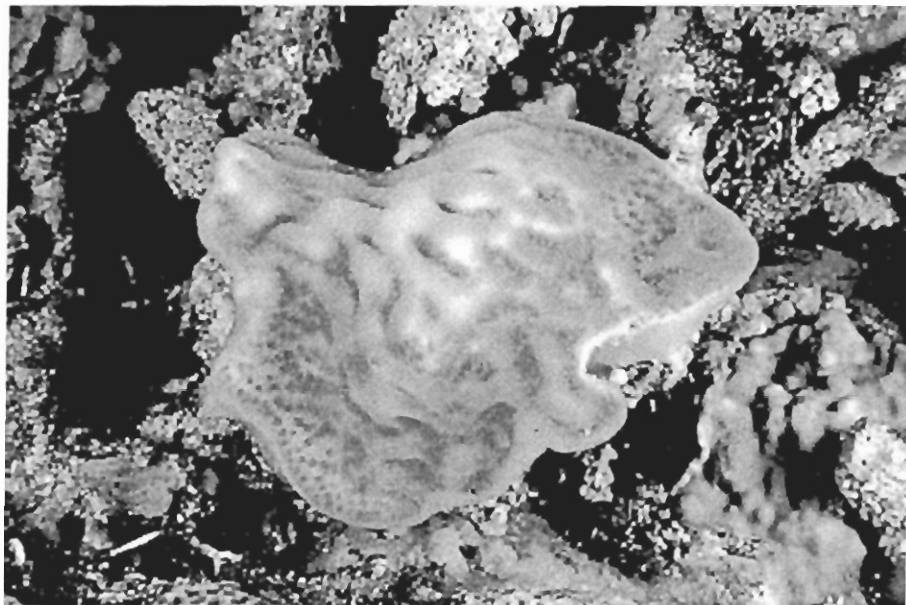

Figure 2.1.4 : *Lissoclinum patella*

2.1.5 *Hyrtios reticulatus*

Phylum	:	Porifera
Class	:	Demospongia
Order	:	Dictyoceratida
Family	:	Irciniidae
Genus	:	<i>Hyrtios</i>
Species	:	<i>Hyrtios reticulatus</i>

The sponge *Hyrtios reticulatus* (see Figure 2.1.5) was collected from Baranglompo Island in Indonesia. It is orange-brown, candle-like with fine rounded protrusions on the surface, and partly growing under corals, and it was collected in the year 1997 at a depth between 20-30 ft. A voucher specimen has been deposited in the Zoological Museum, Amsterdam, under registration number ZMA POR. 17485.

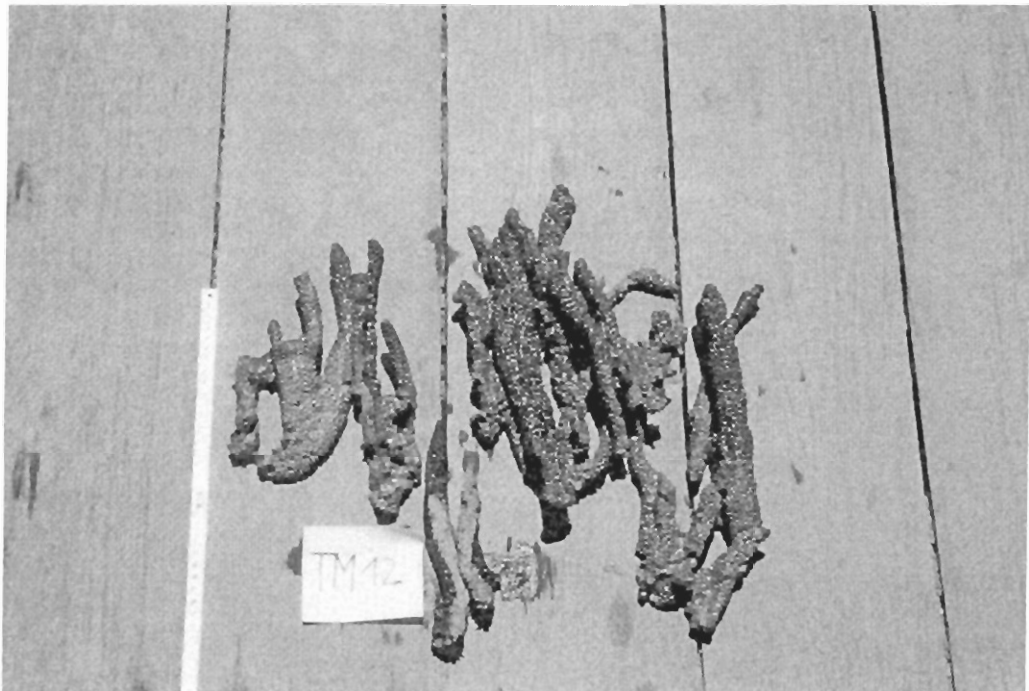

Figure 2.1.5: *Hyrtios reticulatus*

2.2 Chemicals used

2.2.1 General laboratory chemicals

2- Butanol

Agar-Agar	Merck
Anisaldehyde (4-Methoxybenzaldehyde)	Merck
Concentrated sulphuric acid	Merck
Dimethylsulfoxide	Merck
Formaldehyde	Merck
Glacial acetic acid	Merck
Hydrochloric acid 25%	Merck
L-(+) - Ascorbic acid	Merck
Potassium hydroxide	Merck
Trifluoroacetic acid (TFA)	Merck

2.2.2 Solvents

Acetone

Acetonitrile

Dichloromethane

Ethanol

Ethyl acetate

Hexane

Methanol

Petroleum ether

The solvents were purchased from the Institute of Chemistry, University of Düsseldorf. They were distilled before using and special grade solvents were used for spectroscopic measurements.

2.2.3 Chromatography

Pre-coated TLC plates (AluO, silica Gel 60 F254, layer thickness 0.2 mm)	Merck
Pre-coated TLC plates (glass), Rp-18, F254 S, layer thickness 0.25 mm	Merck
Silica Gel 60, 0.04-0.063 mm mesh size	Merck
Sephadex LH 20, 25-100 mm mesh size	Merck
HPLC solvents:	
Methanol LiChrosolv HPLC	Merck
<i>ortho</i> -Phosphoric acid 0.15%, pH 2.0 (prepared from <i>ortho</i> -phosphoric acid 85% p.a.)	Merck
Nanopure water	Barnstead

2.3 Equipments used

Balance	Mettler 200 Mettler AT 250 Mettler PE 1600 Sartorius RC210P
Centrifuge	Kendro D-37520 osterde
Fraction collector	ISCO Cygnet
Freeze dryer	LYOVAC GT2 ; Pump TRIVAC D10E
Hot plate	Camag
Syringe	Hamilton 1701 RSN
Mill	Molinox 354
Magnetic stirrer	Variomag Multipoint HP
Mixer	Braun
pH-Electrode	Inolab Behrotest pH 10-Set
Rotary evaporator	Buechi Rotavap RE 111; Buechi Rotavap R -200
Drying ovens	Heraeus T5050
Sonicator	Bandelin sonorex RK 102
UV lamp	Camag (254 and 366)
Vacuum exicator	Solvent speed vac SPD 111V

2.3.1 HPLC equipment

I Gynkotec

Pump: Gynkotec, M40
HPLC program: Gynkosoft (v.5.4)
Detector: Gynkotec, Photodiode Array Detector UVD 340
Autosampler: Gynkotec Autosampler GINA 50
Printer: NEC P60

II Dionex

HPLC program: Chromeleon Ver 6.3
Pump: Dionex P580A LPG
Detector: Dionex, Photodiode Array Detector UVD 340S
Autosampler: ASI-100T
Column thermostat: NEC P60

2.3.2 Preparative HPLC

HPLC program: Varian-preparative HPLC system
Pump: Prostar 210/215
Detector: Prostar 320, super prep. 4mm-15mm
Column: Varian Dynamax 250x21.4 mm

2.4 Chromatographic methods

2.4.1 Thin layer chromatography

TLC was performed on pre-coated TLC plates with Si gel 60 F254 (layer thickness 0.2 mm, E. Merk. Darmstadt, Germany). Hexane: EtOAc (90:10, 80:20 and 70:30) were used as eluents for semi-polar compounds; CH₂Cl₂: MeOH (90:10 and 70:30) for the brominated alkaloids. TLC on reversed phase (RP)-C18 F₂₅₄ (layer thickness 0.25 mm, E. Merk. Darmstadt, Germany) was also used for polar alkaloids using the solvent systems MeOH: H₂O: TFA (50 : 50 : 1%, 40 : 60 : 1%, and 60 : 40 : 1%). The compounds were detected from the UV absorbance at 254 and 366 nm or by spraying with anisaldehyde reagent followed by heating at 110°C.

Preparation of anisaldehyde as follow:

Anisaldehyde /H₂SO₄ spray reagent (DAB10)

Anisaldehyde: 5 parts

Glacial acetic acid: 10 parts

Methanol: 75 parts

Conc. H₂SO₄: 5 parts (added slowly)

The solution was stored in amber-coloured bottles and kept refrigerated until use. TLC was used to identify the fractions and for the pure compounds to determine the purity of the isolated compounds.

2.4.2 Column chromatography

The crude extracts were subjected to a series of chromatographic columns using different stationary phases and solvent systems. Further purification of the fractions was performed by semi-preparative HPLC.

Types of columns used (according to the stationary phase):

Stationary phase : Sephadex LH-20 (15-100 cm)

Solvent system : Methanol

Stationary phase : RP-18 (different sizes)

Solvent system : Methanol: nanopure water

Stationary phase : Silica gel (different sizes)

Solvent system : DCM: MeOH: NH₄OH, DCM: MeOH and Hexane: EtOAc

Stationary phase : Deion HP-20

Solvent system : Methanol: nanopure water

2.4.3 Semi-preparative HPLC

Semi-preparative HPLC was used for the isolation of pure compounds from fractions eluted by column chromatography. Each injection was in concentration of 3 mg of the dried fraction dissolved in 1 ml of the solvent system. The injection volume up to 1 ml was injected into the column and the flow rate 5 ml/min. The eluted peaks were detected by UV detector (see Tables 2.4.3.1, 2 and 3).

Table 2.4.3.1: Solvent system used for isolation of the brominated alkaloids

Time (min)	% of solvent B (MeOH)	% of solvent A [H ₂ O (0.1%TFA)]
0	0	100
5	20	80
35	100	0
40	100	0
50	0	100

Table 2.4.3.2: Solvent system used for isolation of the polar alkaloids

Time (min)	% of solvent B (MeOH)	solvent A [H ₂ O]
0	0	100
5	0	100
35	100	0
40	100	0
50	0	100

Table 2.4.3.3: Solvent system used for isolation of the cyclic peptides

Time (min)	% of solvent B (MeOH)	% of solvent A [H ₂ O]
0	0	100
5	60	40
35	100	0
40	100	0
50	0	100

2.4.4 Preparative HPLC

The preparative HPLC was used for the isolation of pure compounds from fractions eluted by column chromatography or fractions eluted by VLC. Each injection was in concentration of 8 mg of the dried fraction dissolved in 1 ml of the solvent system. The injection volume up to 5 ml was injected into the column and the flow rate 20 ml/min. The eluted peaks were detected by UV detector (see Table 2.4.4.1).

Table 2.4.4.1: The solvent system used for isolation of the β -carboline alkaloid

Time (min)	% of solvent B (MeOH)	% of solvent A [H ₂ O]
0	0	100
5	10	90
20	100	0
25	100	0
30	0	100

2.4.5 Analytical HPLC

Analytical HPLC was used to identify the content of the fractions and to check the degree of purity of the isolated compounds. The gradients used were different:

- 1) Start with 100% H₂O (pH = 2, with *O*-phosphoric acid) to 100% methanol in 35 minutes.
- 2) Start with 90% H₂O (pH = 2, with *O*-phosphoric acid) to 100% methanol in 35 minutes, the detection of the peaks was by UV-VIS diode detector.

2.4.6 Vacuum liquid chromatography

Vacuum liquid chromatography (VLC) is a useful method as the initial isolation procedure for the large amount of sample. The apparatus consists of a 500 ml sintered glass Buechner filter funnel; with an inner diameter of 12 cm. Fractions are collected in Erlenmeyer flasks (Figure 2.4.6). Silica gel 60 was packed to a hard cake at a height of 5 cm under applied vacuum. The sample used was incorporated in a small amount of silica gel using volatile solvent. The resulting sample mixture was then packed onto the top of the column. Step gradient elution with non-polar solvent (Hexane) then increasing the amount of the polar solvent (EtOAc, MeOH) is added to each successive fraction. The flow is produced by vacuum and the column is allowed to run dry after each fraction collected.

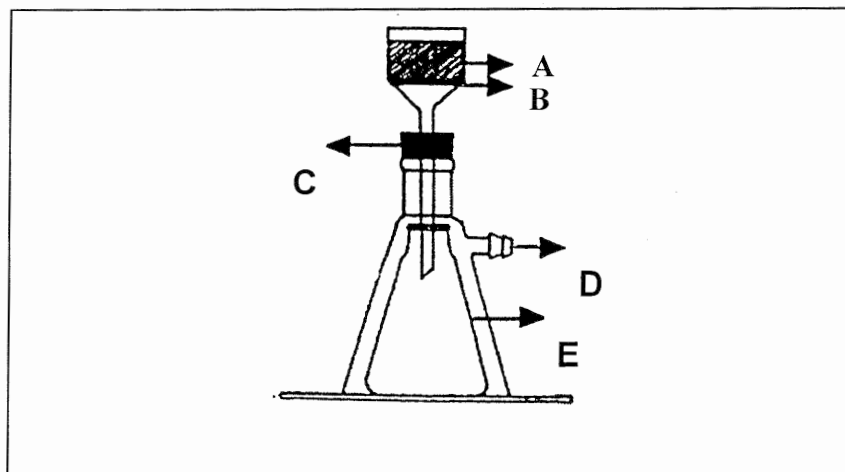

Figure 2.4.6: Vacuum liquid chromatography apparatus

A- Sintered glass adsorbent, Si 60

B- Sintered glass Buechner filter funnel

C- Rubber gasket

D- To vacuum pump

E- Flask collector

2.5 Procedure for the isolation of secondary metabolites

2.5.1 Isolation of secondary metabolites from *Stylissa carteri*

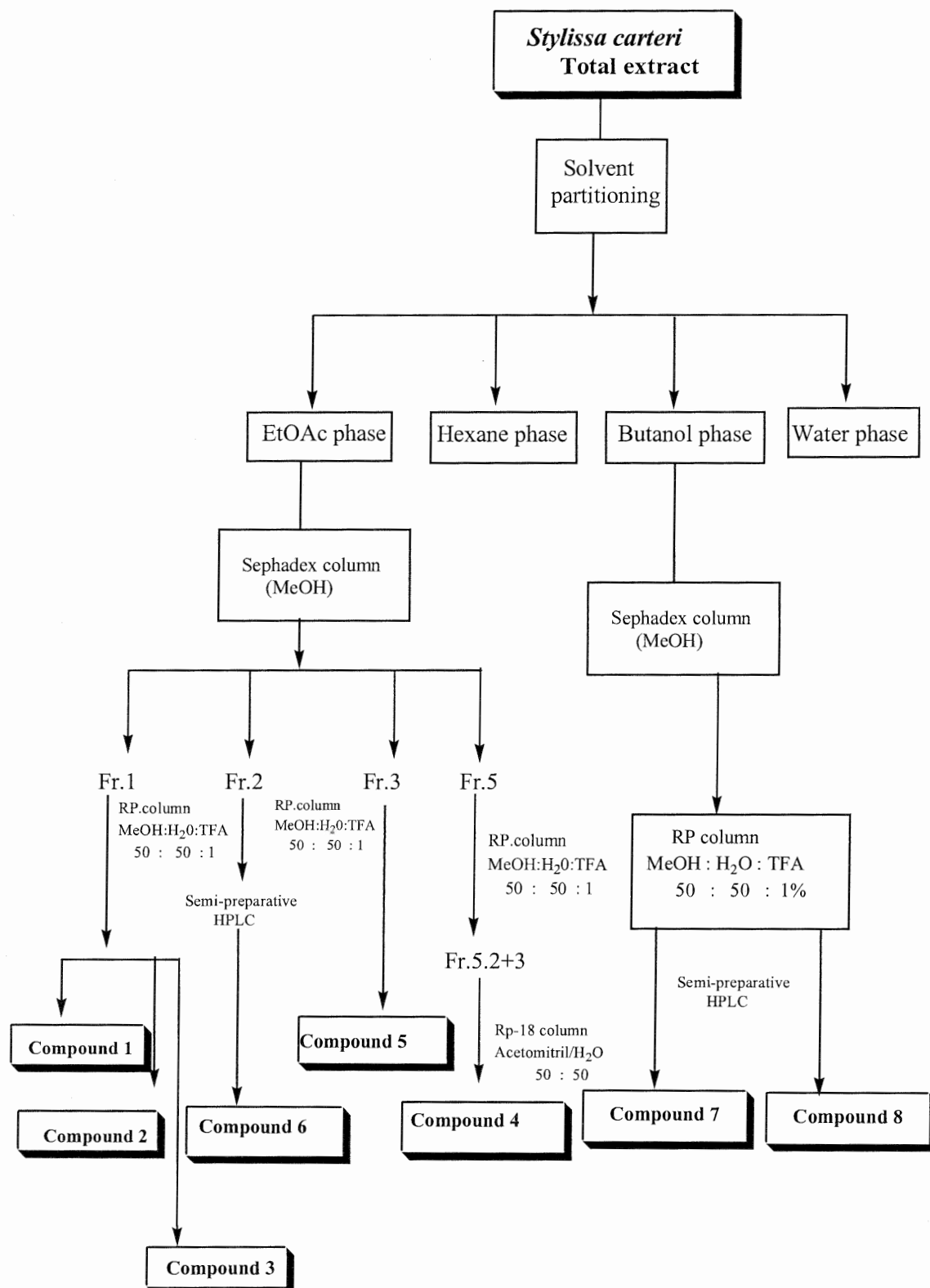

2.5.2. Isolation of secondary metabolites from *Diacarnus megaspinorhabdosa*

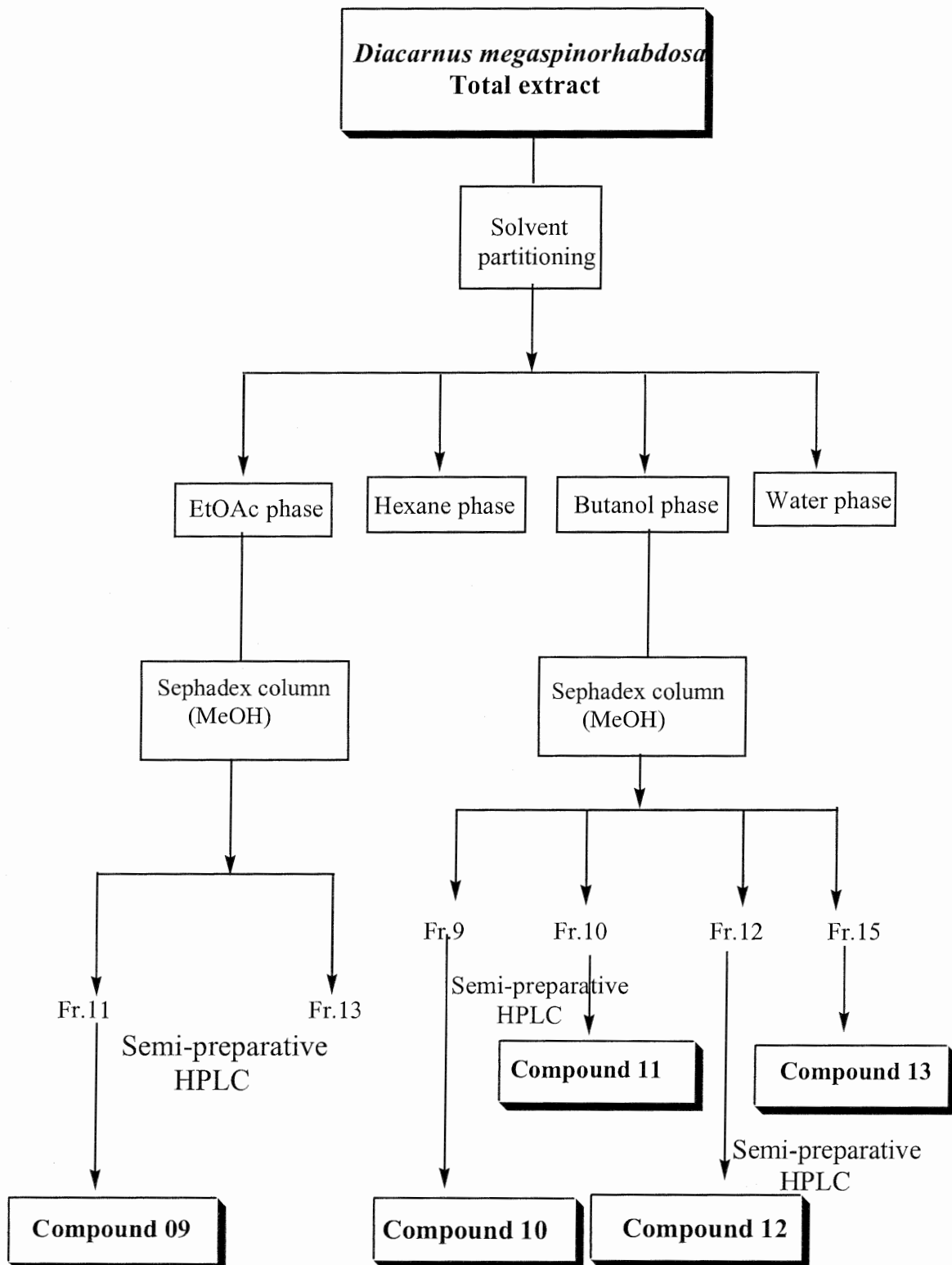

2.5.3 Isolation of secondary metabolites from *Fascaplysinopsis reticulata*

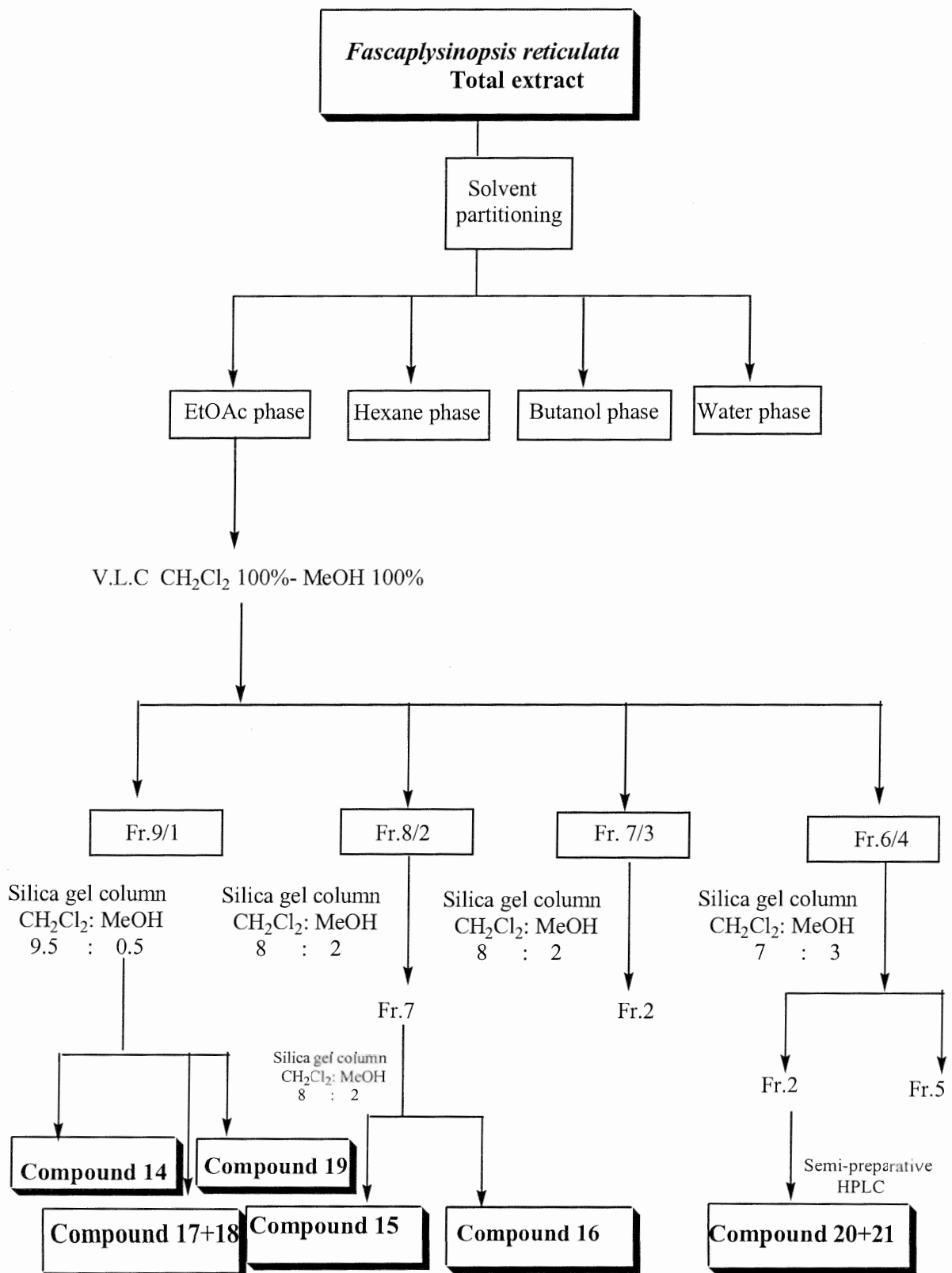

2.5.4 Isolation of secondary metabolites from tunicate *Lissoclinum patella*

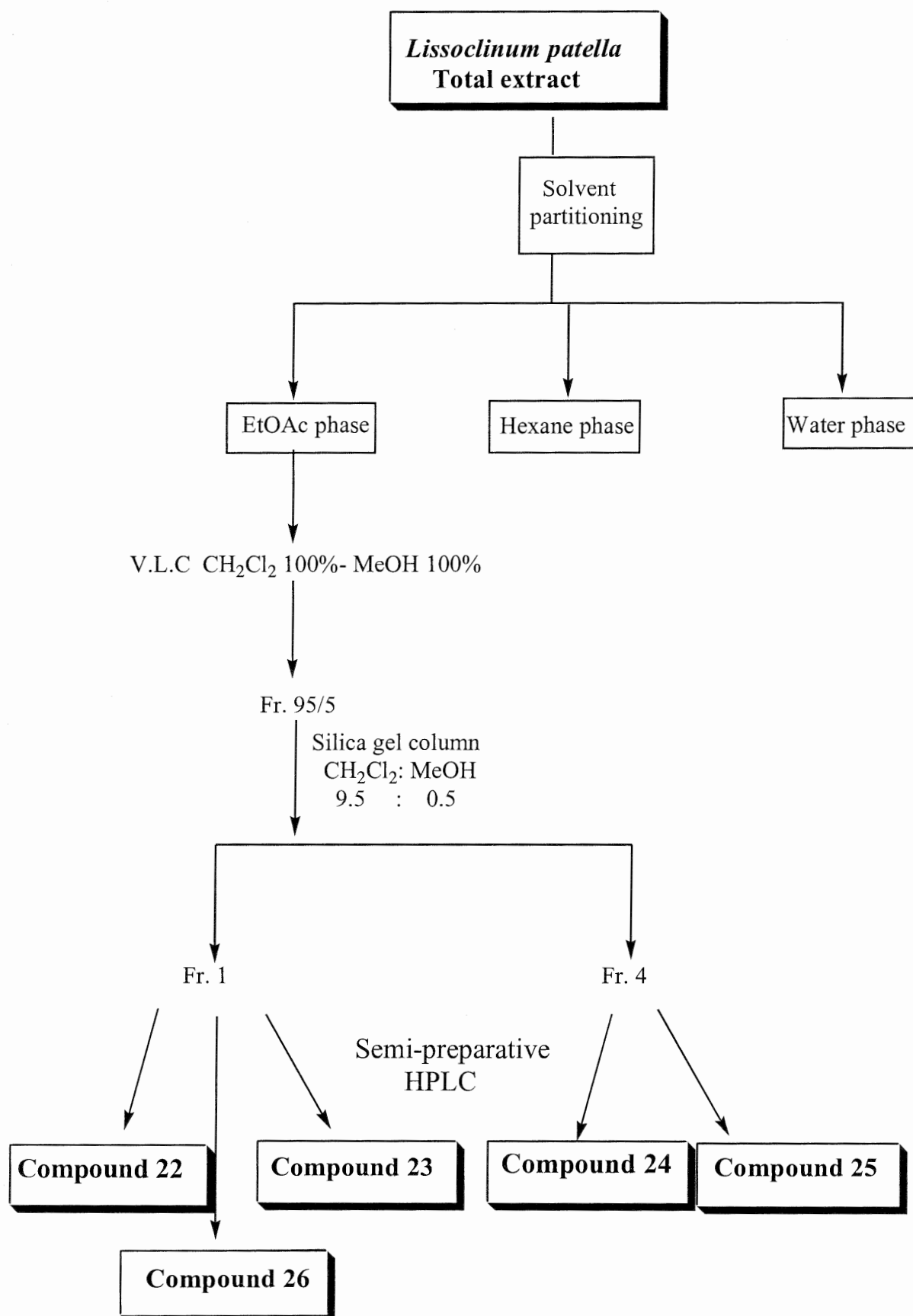

2.5.5 Isolation of secondary metabolites from *Hyrtios reticulatus*

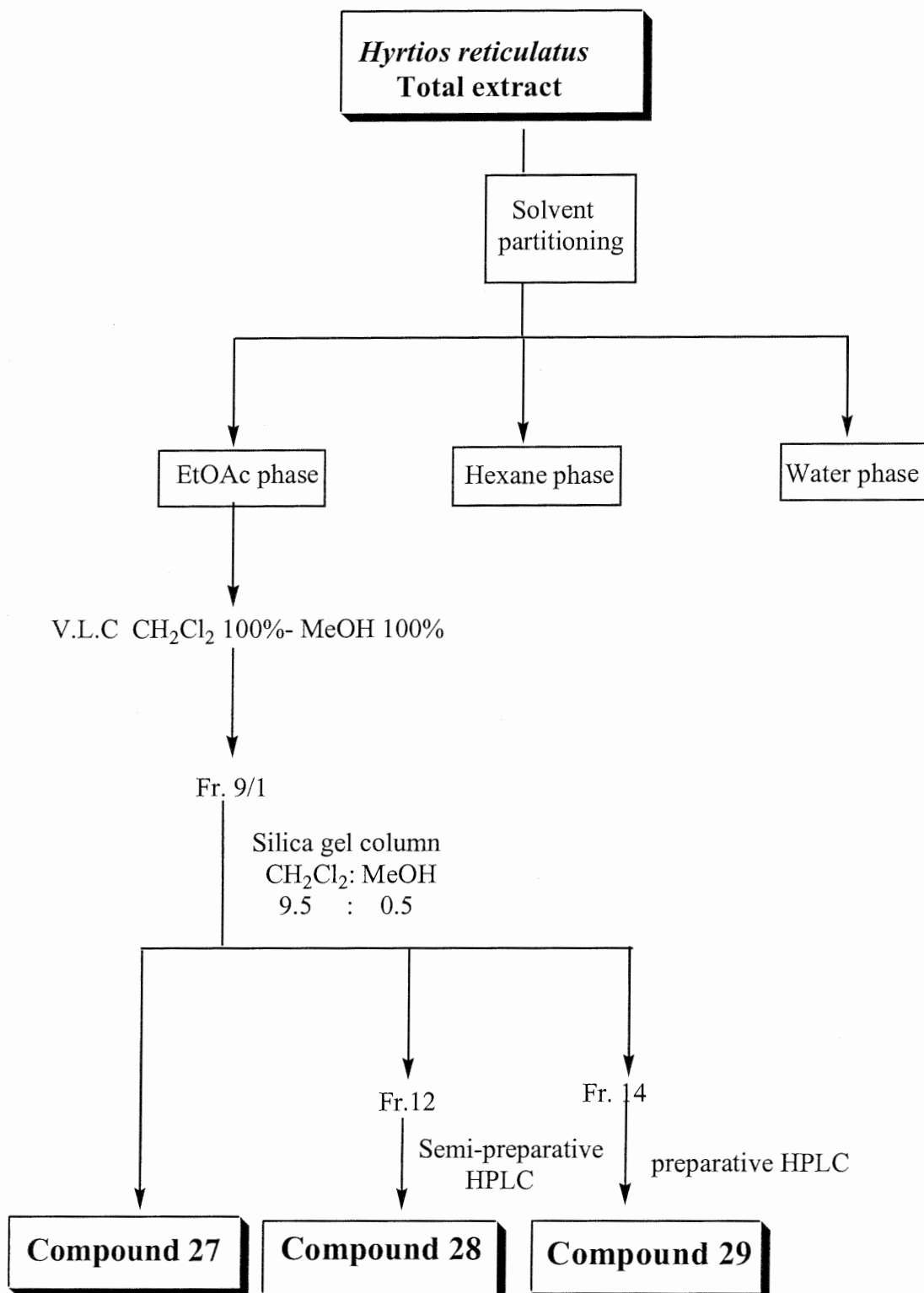

2.6 Structure elucidation of the isolated compounds

2.6.1 Mass spectrometry (MS)

Low Resolution MS low resolution mass spectra were measured by ESI, EI and FAB-MS on a Finnigan MAT 8430 mass spectrometer. The measurements were done by Dr. Peter Tommes, Institute für Anorganische Chemie und Strukturchemie, HHU Düsseldorf.

EIMS (electron impact mass spectroscopy) analysis involves vaporising a compound in an evacuated chamber and then bombarding it with electrons having 25-80 eV of energy. The high energy electron stream not only ionizes an organic molecule (requiring about 7-10 eV) but also causes extensive fragmentation. The advantage is that fragmentation gives rise to a pattern of fragment ions which can help to characterize the compounds. The disadvantage is the frequent absence of a molecular ion.

ESIMS (electro spray ionization) is a method for ejecting ionized molecules from a solution by creating a fine spray of highly charged droplets in the presence of a strong electric field. This type of ionization is highly conducive to the formation of multiply charged molecules.

High Resolution MS high resolution mass is achieved by passing the ion beam through an electrostatic analyser before it enters the magnetic sector. In a double focusing mass spectrometer, ion masses can be measured with an accuracy of about 1 ppm. With measurement of this accuracy the atomic composition of the molecular ion can be determined.

FABMS (fast atom bombardment) FAB is useful for compounds, especially polar molecules, unresponsive to either EI or CI mass spectrometry. It enables both non-volatile and high molecular weight compounds to be analysed. In this technique, a sample is dissolved or dispersed in a polar and relatively non-volatile liquid matrix, introduced into the source on a copper probe tip. Next, this matrix is bombarded with beam of atoms of about 8 Kev. It uses a beam of neutral gas (Ar or Xe atoms) and both positive and negative ion FAB spectra can be obtained.

LC/MS high pressure liquid chromatography (HPLC) is a powerful method for the separation of complex mixtures. If a mass spectrum of each component can be determined as it elutes from the LC column a quick characterization of the components can be done. ESIMS (electron spray ionization mass spectrometry) is interfaced with LC to make an effective online LC/MS. HPLC/ESIMS was carried out using a Finnigan MAT TSQ-7000 mass spectrometer connected to a UV detector. The sample is dissolved in water or methanol or a mixture of both and injected to HPLC/ESIMS set up. HPLC was run on a Nucleosil C-18 reversed phase column. Measurement was done at the Institute of Pharmaceutical Biology, HHU Düsseldorf.

2.6.2 Nuclear magnetic resonance spectroscopy (NMR)

NMR measurements were done by Dr. Peter, at the Institute of Inorganic and Macromolecular Chemistry of Heinrich-Heine University Düsseldorf and by Dr. Victor Wray, at the Gesellschaft für Biotechnology Forschung (GBF) in Braunschweig. ^1H - and ^{13}C -NMR spectra were recorded at 300° K on Bruker DPX 300, ARX 400, 500 or AVANCE DMX 600 NMR spectrometers. All 1D and 2D spectra were obtained using the standard Bruker software. The samples were dissolved in deuterated solvents (DMSO- d_6 , CDCl_3 and CD_3OD), the choice of the solvent depends mostly on the solubility of the compound. Solvent signals at 3.3 ppm and 49.0 ppm (CD_3OD), 7.26 ppm and 77.0 ppm (CDCl_3), 2.49 ppm and 39.5 ppm (DMSO- d_6) were considered as internal reference signals for calibration. The observed chemical shift values (δ) are given in ppm and the coupling constants (J) in Hz.

For structure elucidation of the isolated compounds, several analytical NMR techniques were used to afford an independent, unambiguous confirmation of the signal assignments, substituent positions and total structure. **HMBC** (Hetero Multinuclear Bond Coherence) was utilised to obtain long range correlations of proton and carbon nuclei through two to three bonds and **HMQC** (Hetero Multinuclear Quantum Coherence) was used to correlate proton and carbon nuclei through one bond coupling. **DEPT** (Distortionless Enhancement by Polarization Transfer) is a type of spectral editing technique to distinguish and classify the carbons as (CH), (CH₂) or (CH₃). ^{13}C -NMR was used for the determination of the quaternary carbons.

2.7 Bioassay

2.7.1. Antimicrobial activity

Micro-organisms

The crude extracts and the pure compounds were tested for activity against the following standard strains: gram positive bacteria *Bacillus subtilis*; gram-negative bacteria *Escherichia coli*; the yeast *Saccaromyces cerevisiae* and two fungal strains *Cladosporium herbarum* and *C. cucumerinum*.

Culture preparation

The agar diffusion assay was performed according to the Dauer Kirby Test (DIN 58940, Bauer *et al.*, 1966). Prior to testing, a few colonies (3 to 10) of the organism to be tested were subcultured in 4 ml of tryptose-soy broth (Sigma, Germany) and incubated for 2 to 5 hr. to produce a bacterial suspension of moderate cloudiness. The suspension was diluted with sterile saline solution to a density visually equivalent to that of BaSO₄ standards. The standards were prepared by adding 0.5 ml of 1 % BaCl₂ to 99.5 ml of 1% H₂SO₄ (0.36 N). The prepared bacterial broth was inoculated onto Müller-Hinton-Agar plates (Difco, USA) and dispersed by means of sterile beads.

Agar diffusion assay

For screening, aliquots of the test solution were applied to sterile filter paper discs (5 mm diameter, Oxid. Ltd) using a final disc loading concentration of 500 µg for the crude extract and 50 and 100 µg for the pure compounds. The impregnated discs were placed on agar plates previously seeded with the selected test organisms, along with discs containing solvent blanks. The plates were incubated at 37° C for 24 hr. and anti-microbial activity was recorded as clear zones of inhibition surrounding the discs. The diameter was measured in mm.

2.7.2 Cytotoxicity test

Cytotoxicity tests were carried out by Prof. Dr. Müller (Mainz University). The assay used mouse lymphoma (L5178Y), rat brain (PC12) and human cervix cancer cells (HELA). L5178Y mouse lymphoma cells were grown in Eagle's minimal essential medium supplement with 10% horse serum in roller tube culture (Kreuter *et al.*, 1992 and Müller *et al.*, 1985). All cells were mycoplasma-free and cultures were propagated under standardized conditions (Drexler *et al.*, 1995). Stock solutions of the freeze-dried test compounds were dissolved in EGMME (ethylene glycol monomethyl ether) or DMSO, diluted with culture medium and stored at -20°C .

For all experiments, exponentially growing cells were used, with viability more than 90% as determined by trypan blue staining. For analysis, the cells were harvested, washed and re-suspended in fresh medium at a final concentration of $2\text{-}4 \times 10^5$ cells/ml according to the cell line used. Total cell number and viability were determined in a cell counting chamber after staining the cells with trypan blue. The cells were seeded out in volumes of 90 μL into 96-well flat-bottom culture plates (Nunc, Wiesbaden, Germany). The test compounds stock solutions were diluted with suitable amounts of culture medium to a concentration of 10 μL , were added to each well and incubated for 48 h at 37°C in 5% CO_2 humidified incubator.

The cytotoxicity was evaluated by the [^3H] thymidine assay (Steube *et al.*, 1992). Radioactive incorporation was carried out for the last 3 hr. of the 48 hr. incubation. One μCi of [methyl- ^3H]-thymidine (Amersham-Buchler, Braunschweig, Germany; specific activity 0.25 mCi/ μmol) was added in a 20 μL volume to each well. Cells were harvested on glass fibre filters with a multiple automatic sample harvester and radioactivity was determined in a liquid scintillation counter (1209 Rackbeta, LKB, Freiburg, Germany). Media with 0.1% EGMME and DMSO were incubated in the experiment as control.

2.7.3 Protein kinase screening assays

The protein kinase screening assays were carried out by Olivier Lozach Station Biologique in France.

The cell cycle (see Figure 2.7.3) is driven and regulated by a variety of complex processes. In the surveillance of the cell cycle, the cyclin-dependant kinases (CDKs) play a central role. The CDKs are a group of serine/threonine kinases, which control the transmission between successive stages of the cell cycle. The activity of the CDKs is regulated by multiple mechanisms, including binding to cyclins, a diverse class of positive regulatory CDK-binding proteins (CKIs). Binding to CKIs results in deactivation of CDKs. An active CDK consists of

a catalytic subunit (CDK1-CDK9) and a regulatory subunit (cyclin A-cyclin J and cyclin T). To maintain the correct temporal ordering of cell-cycle events, individual CDK-cyclin pairs must act only at specific points in the cell cycle. It is now recognized, that controlling the subcellular localization of CDK-cyclins and their regulators is also essential for proper cell-cycle coordination. Progression through G1 and S phases is driven by the G1 cyclins and their catalytic subunits, including CDK2-cyclin A, CDK2-cyclin E, CDK4-cyclin D and CDK6-cyclin D. Activation of mitotic CDK-cyclin complexes promotes progression through the G2-M transition in both mitotic and meiotic cell cycles. Analysis of Cdc2-cyclin A, Cdc2-cyclin B1 and Cdc2-cyclin B2 complexes have revealed that these three major mitotic catalysts exhibit distinct patterns of subcellular localization through the cell cycle.

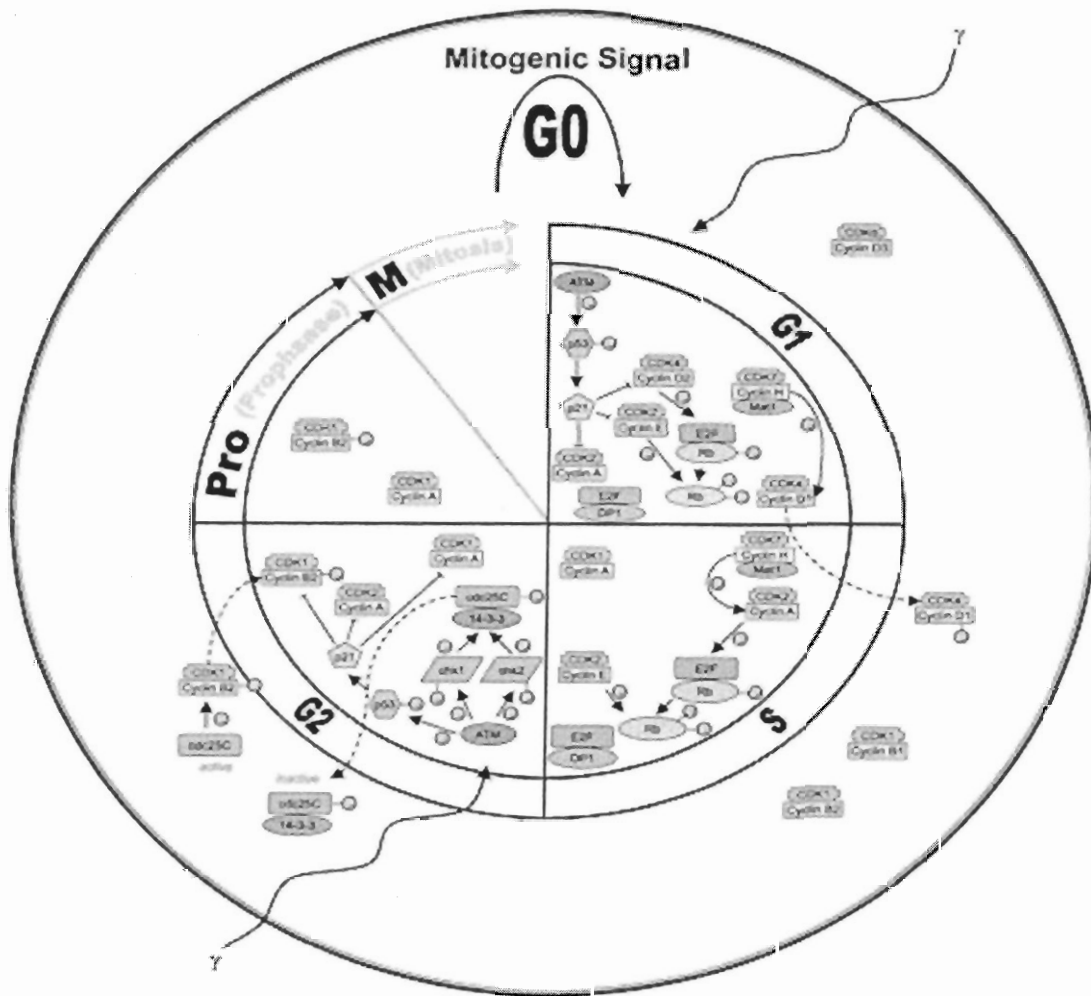

Figure 2.7.3: Cellular distribution of cyclins and checkpoint control induced by irradiation (Ravnik and Wolgemuth, 1999)

2.7.4 Fish-feeding assay

In the experiment with *Blennius sphinx* fishes, food pieces treated with sponge extracts were given to the fishes at the same time as untreated food pieces. If the fishes show a preference for the untreated food pieces this means the extract has fish feeding deterrence activity. In the natural habitat some sponges show defence against predators with the aid of their secondary metabolites. Due to this, the extracts were tested at their natural concentrations as present in the sponge. The amount of extract in 10 ml sponge was determined by the following equation:

$$\text{Density} = \frac{\text{Wet weight}}{\text{Volume}}$$

The preparation of food pieces

The total extract was dissolved in a certain volume of suitable solvent and a volume equal to 10 ml sponge was calculated. 1.053 g food granules were ground to a fine powder in a mortar and put in a round bottom flask, and then the volume of the extract solution (10 ml sponge) was added, mixed well and evaporated to dryness. At the end the food/ extract mixture was detached from the wall of the flask by spatula (Flask A).

0.189 g agar was taken in an Erlenmeyer flask, then 9.5 ml distilled water was added to it. The flask was closed with aluminium foil, boiled on a water bath for four minutes and then cooled to 55° C (Flask B).

The content of flask Blank was added to flask A and mixed well to give the treated food (Experiment, E).

The untreated food was prepared according to the previous steps, but instead of the extract containing solvent pure solvent was used (Blank, B).

Both types of food (experiment and blank) were poured into a frame, this frame containing two openings 2.5 x 25 cm. Under the frame there was a network and plastic foil. One of the openings was filled with E and the other was filled with Blank, the extract/food mixture was distributed to be of 2 mm thickness. After cooling the agar, the frame was removed and the food remained at the network. Six pieces were cut from Blank and Experiment, each 10 squares wide. Each of the blank and the experiment diet was attached to metallic body to sink in the aquarium.

The experiment

Six food bands were put in the aquarium at the same time. The food pieces were observed until one third of the food in each band had been consumed. The empty squares were counted

$$\text{Percentage of eaten food from E} = \frac{e \times 100}{t}$$

$$\text{Percentage of eaten food from B} = \frac{b \times 100}{t}$$

and the percentage of eaten food from both E and B were calculated.

e = number of empty squares from Experiment

b = number of empty squares from Blank

$$t = e + b$$

The fishes used in this experiment (*Blennius sphinx*) were collected from the Mediterranean Sea near Elba Island, Italy.

This test was done for the sponges from the Red Sea; four sponges showed high activity (see Figure 2.7.4).

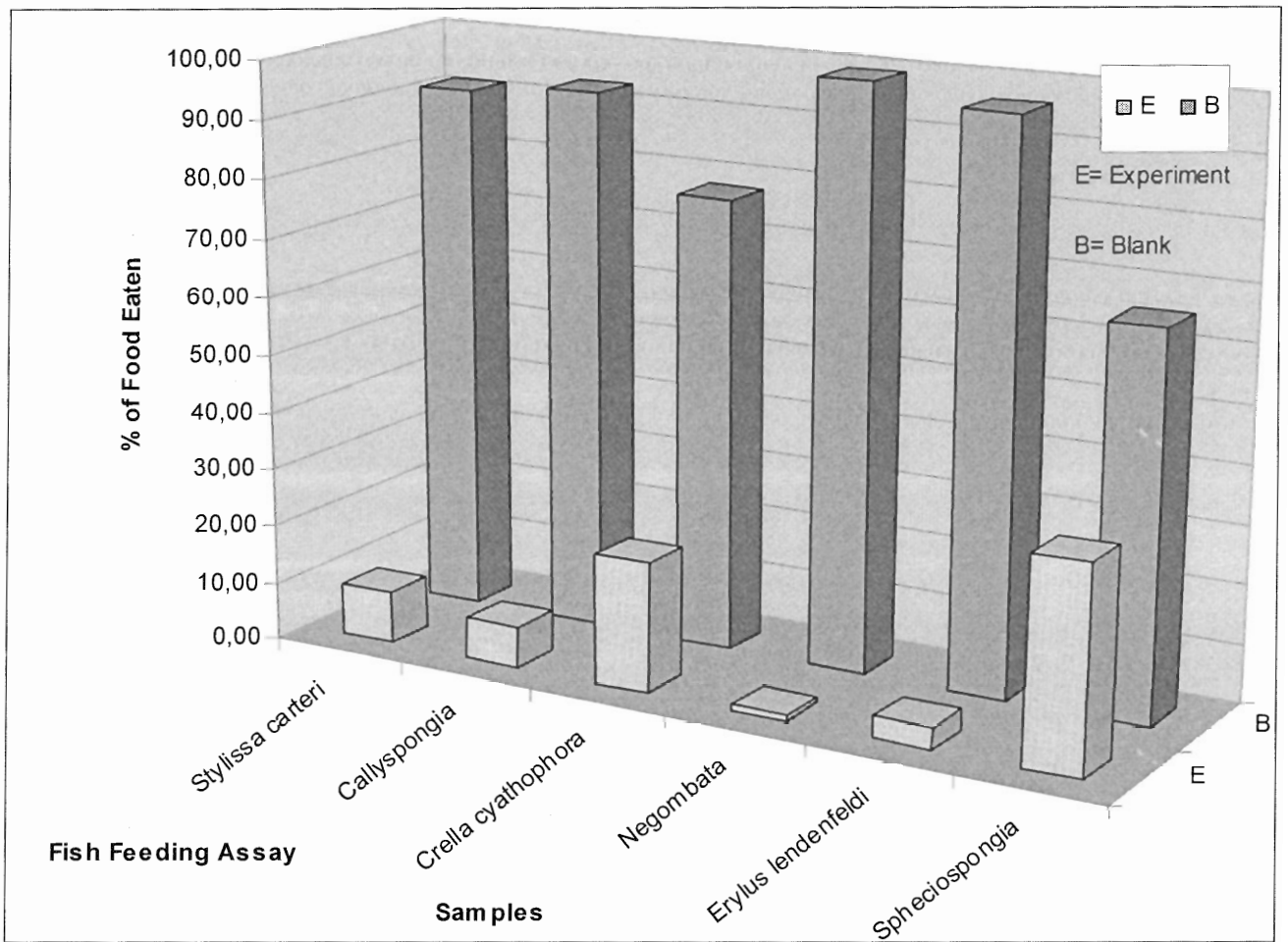

Figure 2.7.4: Fish feeding assay

3. Results

3.1 Isolation and structure elucidation of the secondary metabolites from *Stylissa carteri*.

Bromopyrrole alkaloids are typical secondary metabolites of sponges from the families Agelasidae, Axinellidae and Hymeniacidonidae. Several of these compounds show promising biological activities; they are, for example, cytotoxic, show α -adrenoceptor blocking activity and protein kinase inhibitory properties.

At the beginning of the seventies the structures of the first bromopyrrol alkaloids, oroidin and dibromphakellin, were elucidated (see Figure 3.1). Since that time more than 40 bromopyrrol alkaloid were published (Sharma and Burkholder, 1971; Forenza *et al.*, 1971; Garcia *et al.*, 1973; Kobayashi *et al.*, 1988; Eder *et al.*, 1999).

The compounds of this class are closely related to each other, exhibiting a substituted pyrrole ring with one or more bromine atoms. In some cases there are debrominated analogues (e.g. debromohymenialidisin).

The majority of these compounds contain one or more bromopyrrole moieties combined with or without functional groups such as guanine and dihydroindolizinone (e.g. agelifेरins), biimidazolidinyl-2,2'-diylidenediamine (e.g. axinellamines), bromophenol (e.g. pentabromo-seudilin) or some amino acids forming a brominated pyrrole-containing peptide (e.g. keram-amamides).

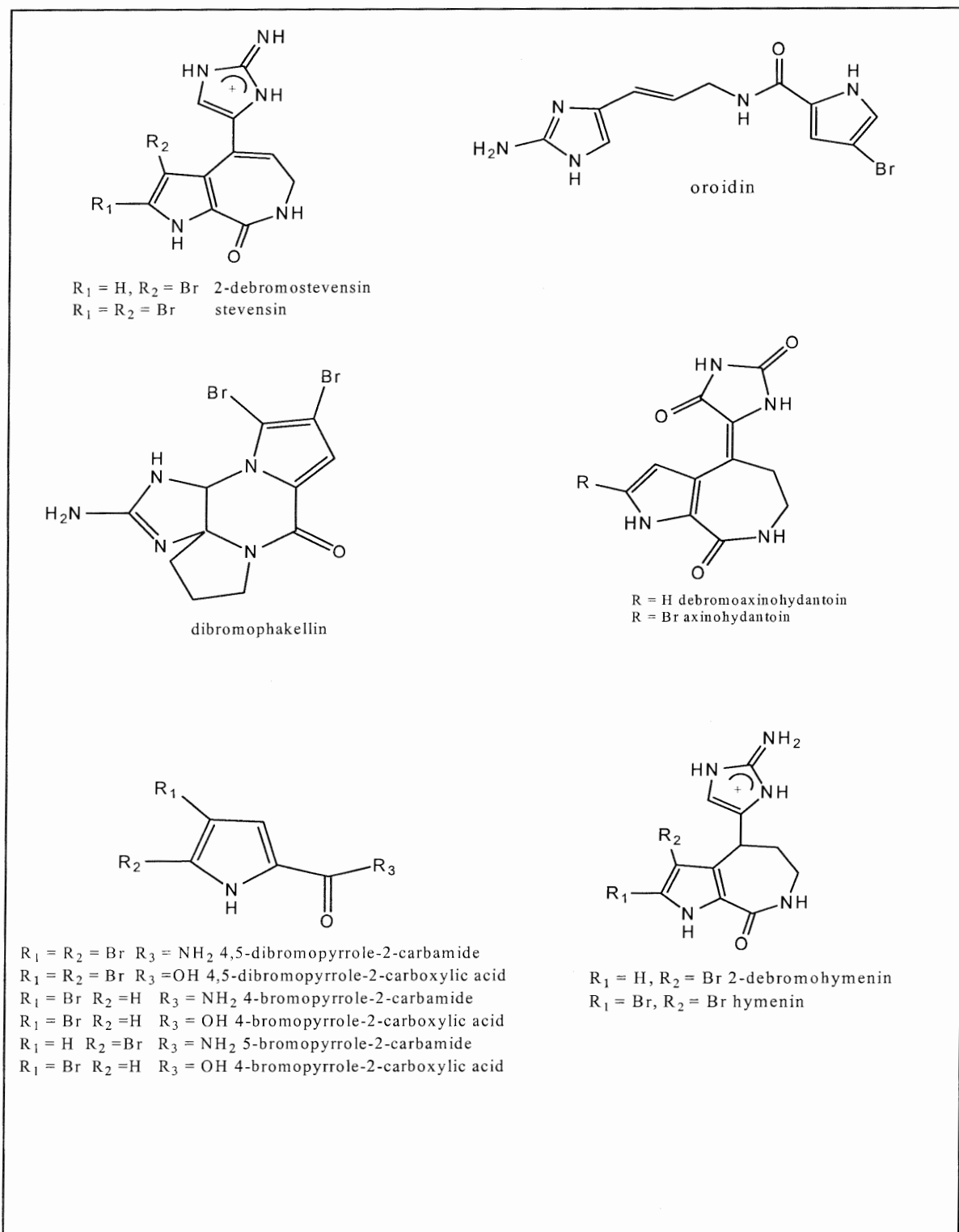

Figure 3.1: Some bromopyrrole metabolites from marine sponges.

Aldisin (compound 01)

Chemical name: 6,7-Dihydro-1H,5H-pyrrol[2,3-c]azepine-4,8-dione

Character: pale yellow powder

Amount: 8mg

Sample code: Stylissa, Et.f.4.4

Molecular Weight: 164 g / mol

Biological source: marine sponge *Stylissa carteri*

Molecular formula: C₈H₈N₂O₂

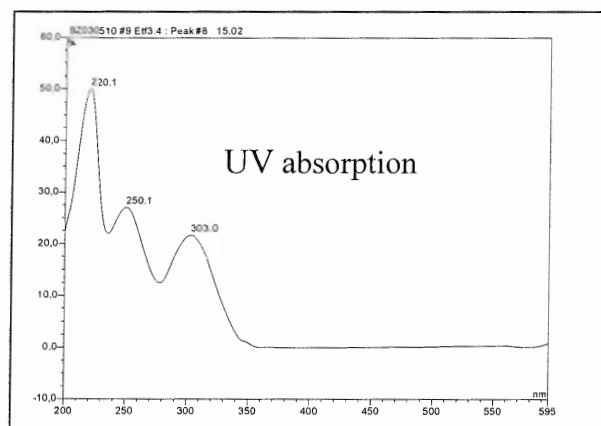
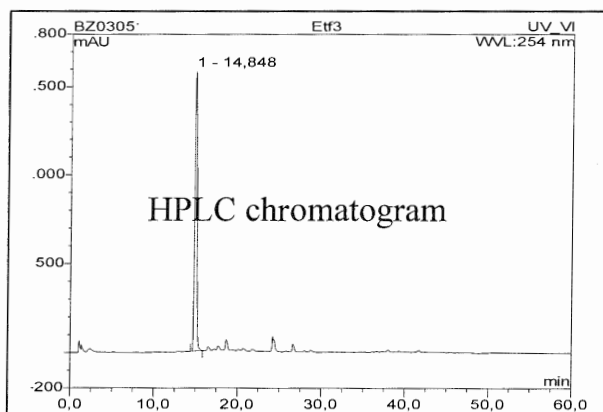
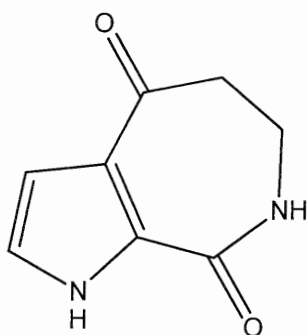

ESIMS: m/z 165 [M+H]⁺ (Positive)

3.1.1 Structure elucidation of aldisin [01].

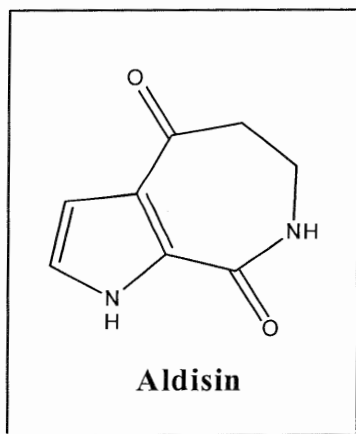

Aldisin is a pyrrololactam alkaloid and was isolated for the first time from the sponge *Hymeniacidon aldis* de Laubenfels which was collected at Guam (Schmitz *et al.*, 1985).

Compound 01 was isolated as pale yellow powder. It has UV absorbances at λ_{\max} 218, 250 and 330 nm. The ESI-MS spectrum (see Figure 3.1.1.A) gave a peak at m/z 165 $[M+H]^+$. This together with the NMR spectra suggested the molecular formula $C_8H_8N_2O_2$.

Two isolated spin system were evident from the 1H -NMR spectrum (see Figure 3.1.1.A), one corresponded to a $-CH=CH-$ group with signals at 6.95 and 6.57 ppm and the other spin system corresponded to the aliphatic system $-NH-CH_2-CH_2-$ with signals at 8.35, 3.32 and 2.77 ppm (see Table 3.1.1.A).

The ^{13}C -NMR and DEPT spectra (see Figure 3.1.1.C) exhibited in addition to the two singlet carbonyl signals at 194.6 and 162.5 ppm, doublets at 122.6 and 109.8 ppm, singlets at 123.9 and 127.9 ppm and two triplets for aliphatic carbons at 36.9 and 43.8 ppm. The chemical shifts of the doublet signals at 122.6 and 109.8 ppm were compatible with those expected for C-2 and C-3 in a pyrrole ring (see Table 3.1.1.B).

Comparison of the NMR data of compound [01] with those reported by (Schmitz *et al.*, 1985) showed that both spectra were very similar, suggesting that the two compounds are identical.

Results

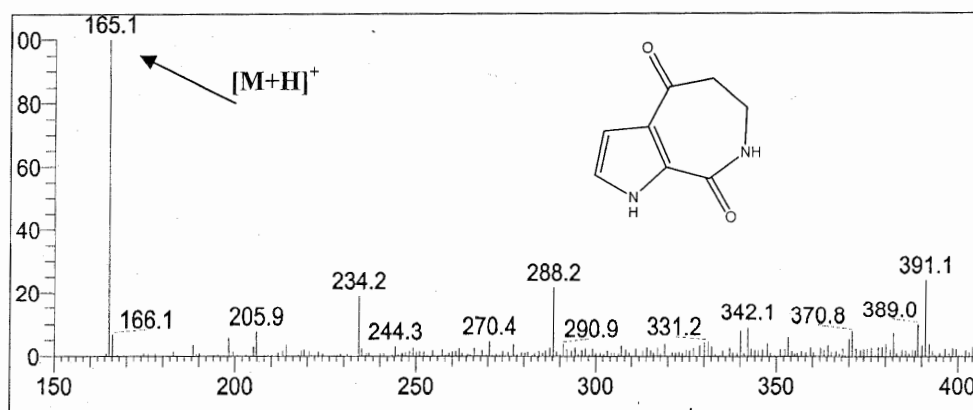

Figure 3.1.1.A: ESI⁺ mass spectrum of aldisin (compound 01)

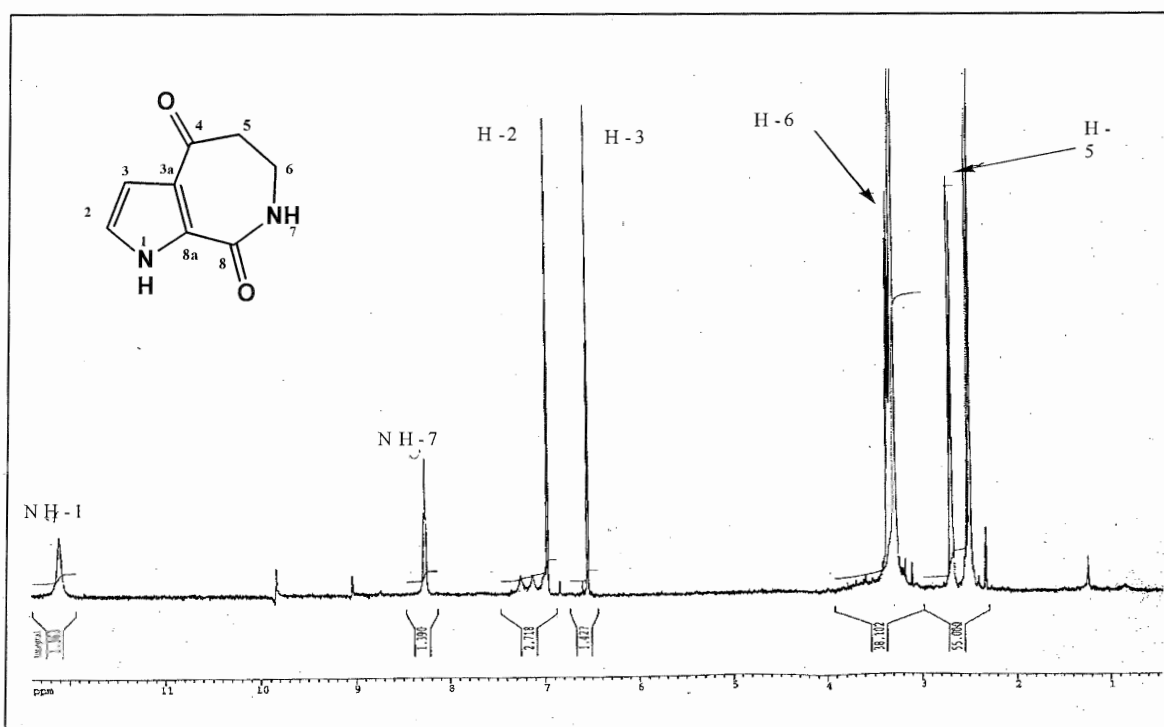

Figure 3.1.1.B: ¹H-NMR spectrum of aldisin (compound 01)

Table 3.1.1.A: ¹H-NMR data of aldisin (compound 01)

H-No.	¹ H NMR (ppm), multiplicity (Hz) aldisin	¹ H NMR (ppm), multiplicity (Hz) aldisin*
H-2	6.95 (1H, dd. $J=2.7$ Hz)	7.00 (1H, d. $J=2.5$ HZ)
H-3	6.57 (1H, dd. $J=2.6$ Hz)	6.89 (1H, d. $J=2.5$ HZ)
H-5	2.77 (2H, m)	2.85 (2H, m)
H-6	3.32 (2H, m)	3.55 (2H, m)
NH-1	12.2 (br. s)	Not reported
NH-7	8.3 (br. s)	Not reported

The compound was measured in DMSO-*d*₆.

* Measured in CDCL₃-CD₃OD (Schmitz *et al.*, 1985)

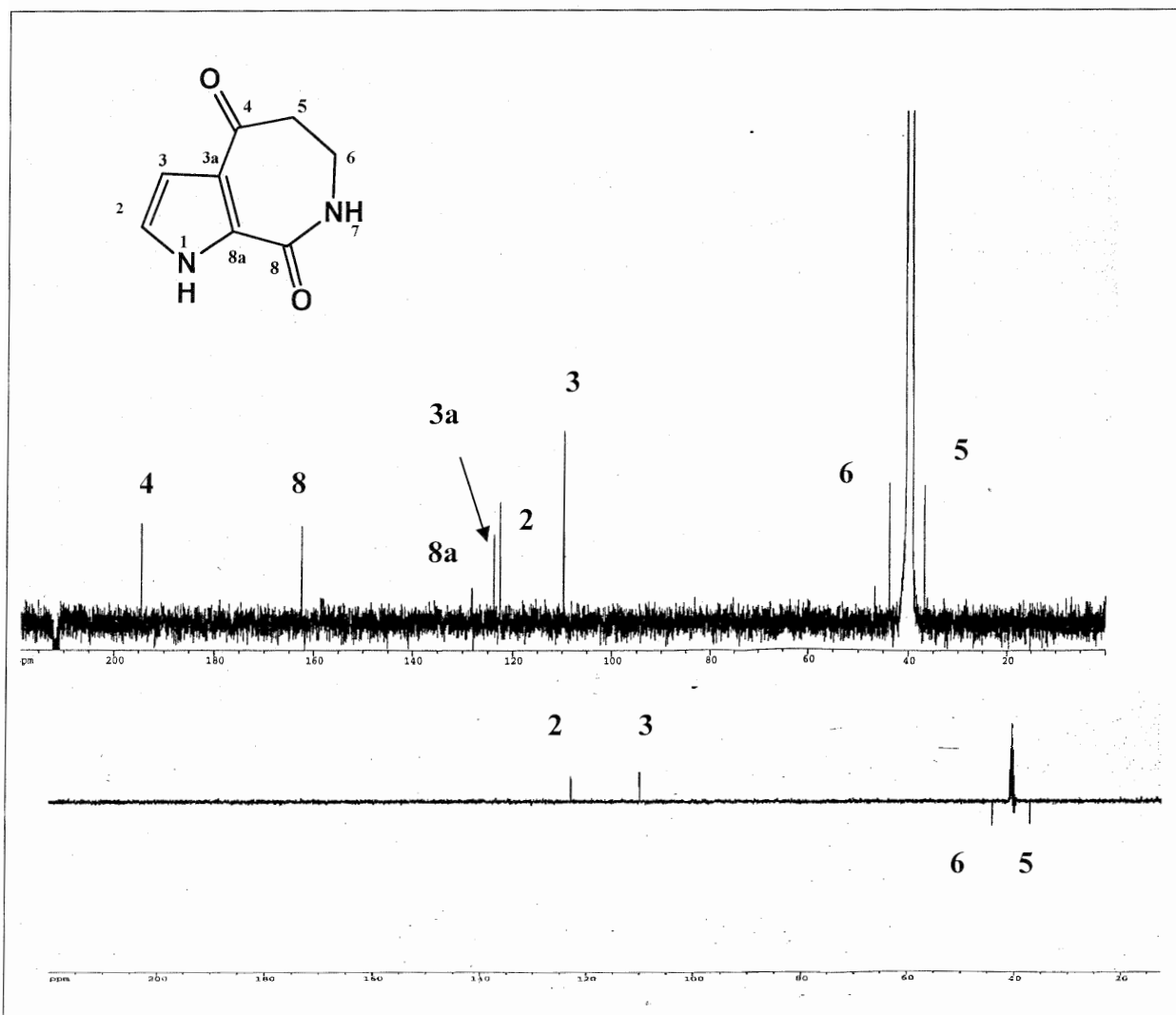

Figure 3.1.1.C: ^{13}C -NMR and DEPT spectra of aldisin (compound 01)

Tabel 3.1.1.B: ^{13}C -NMR data of aldisin (compound 01)

C-No.	^{13}C -NMR (ppm) of aldisin	^{13}C -NMR (ppm) aldisin*
C-2	122.6, d	122.6, d
C-3	109.8, d	109.0, d
C-3a	123.9, s	123.9, s
C-4	194.6, s	194.5, s
C-5	36.9, t	36.6, t
C-6	43.8, t	43.9, t
C-8	162.5, s	162.2, s
C-8a	127.9, s	128.3, s

The compound was measured in $\text{DMSO}-d_6$.

* Measured in CDCl_3 - CD_3OD 1:1 (Schmitz *et al.*, 1985)

2-Bromoaldisin (compound 02)

Chemical name: 2-Bromo-6,7-dihydro-pyrrolo[2,3]azepine-4,8-dione

Character: pale yellow powder

Amount: 7 mg

Sample code: Stylissa, Et.f.3.3, f2.3

Molecular Weight: 242/244 g / mol

Biological source: marine sponge *Stylissa carteri*

Molecular formula: C₈H₇N₂O₂Br

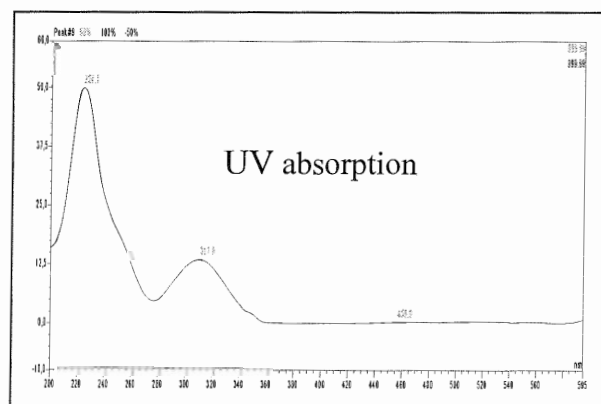
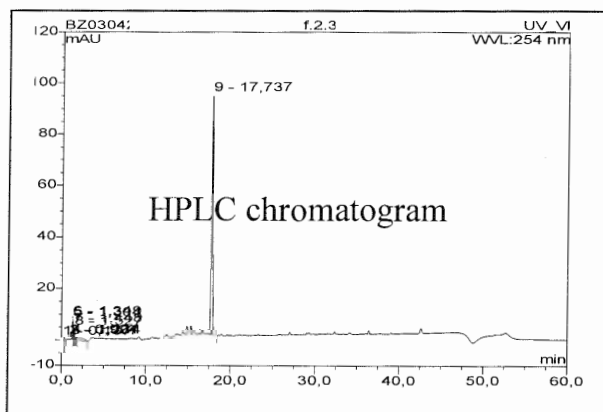
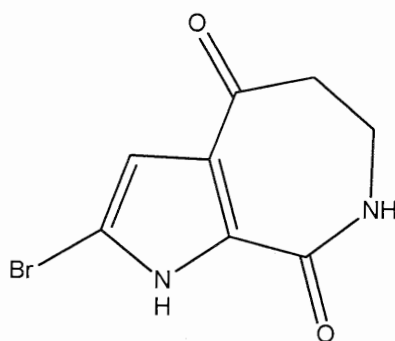

ESIMS: m/z 243/245 [M+H]⁺ (Positive)

3.1.2 Structure elucidation of 2-bromoaldisin [02].

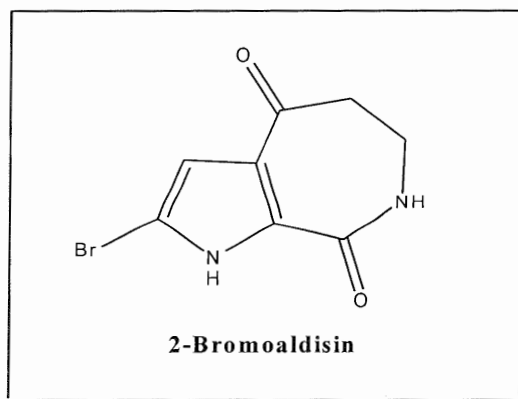

2-Bromoaldisin is also a pyrrololactam alkaloid. It was for the first time isolated from the sponge *Hymeniacidon aldis* de Laubenfels which was collected at Guam (Schmitz *et al.*, 1985). It is the first time that this alkaloid is reported from *Stylissa carteri*.

Compound 02 was isolated as pale yellow powder. It has UV absorbances at λ_{max} 229 and 310 nm. The ESI-MS spectrum (see Figure 3.1.2.A) gave isotopic clusters at m/z 243 and 245 in a ratio of 1:1 $[M]^+$, indicating a monobrominated compound. This together with the NMR spectra suggested the molecular formula $C_8H_8N_2O_2Br$.

The 1H -NMR spectrum of compound **02** (see Figure 3.1.2.B) exhibited two spin systems, one corresponded to a singlet olefinic proton at 6.51 ppm, and the other spin system corresponded to the aliphatic system $-NH-CH_2-CH_2-$ with resonances at 8.48, 3.10 and 2.72 ppm (see Table 3.1.2.A).

The ^{13}C -NMR and DEPT spectra (see Table 3.1.2.B) exhibited in addition to the two singlet carbonyl signals at 191.5 and 160.2 ppm, another singlet carbon signal at 103.0 ppm and a doublet carbon signal at 111.6 ppm these signals were compatible with those expected for C-2 and C-3 in a brominated pyrrole ring. Furthermore two triplet carbon signals corresponding to the two methylene groups in the azepine ring and were observed at 43.7 and 36.7 ppm, respectively.

The 1H -NMR and ^{13}C -NMR spectra of compound **02** are very similar to those of compound **01** with a few notable exceptions. Thus compound **02** lacked the H-2 doublet signal present in compound **01**, the H-3 signal in 2-bromoaldisin was only a singlet and the ^{13}C -NMR signal assigned to C-2 in aldisin was shifted from 122.6 to 103.0 ppm in 2-bromoaldisin.

Comparison of the NMR data of compound **[02]** to those reported by (Schmitz *et al.*, 1985) showed that both spectra were very similar, suggesting that the two compounds are identical.

Results

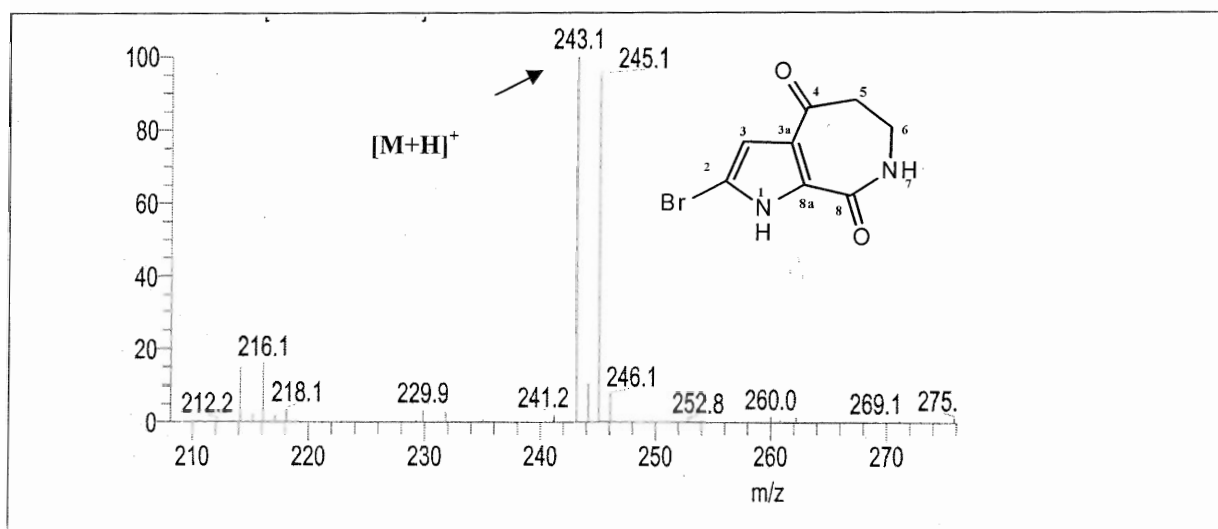

Figure 3.1.2.A: ESI⁺ mass spectrum of 2-bromoaldisin (compound 02)

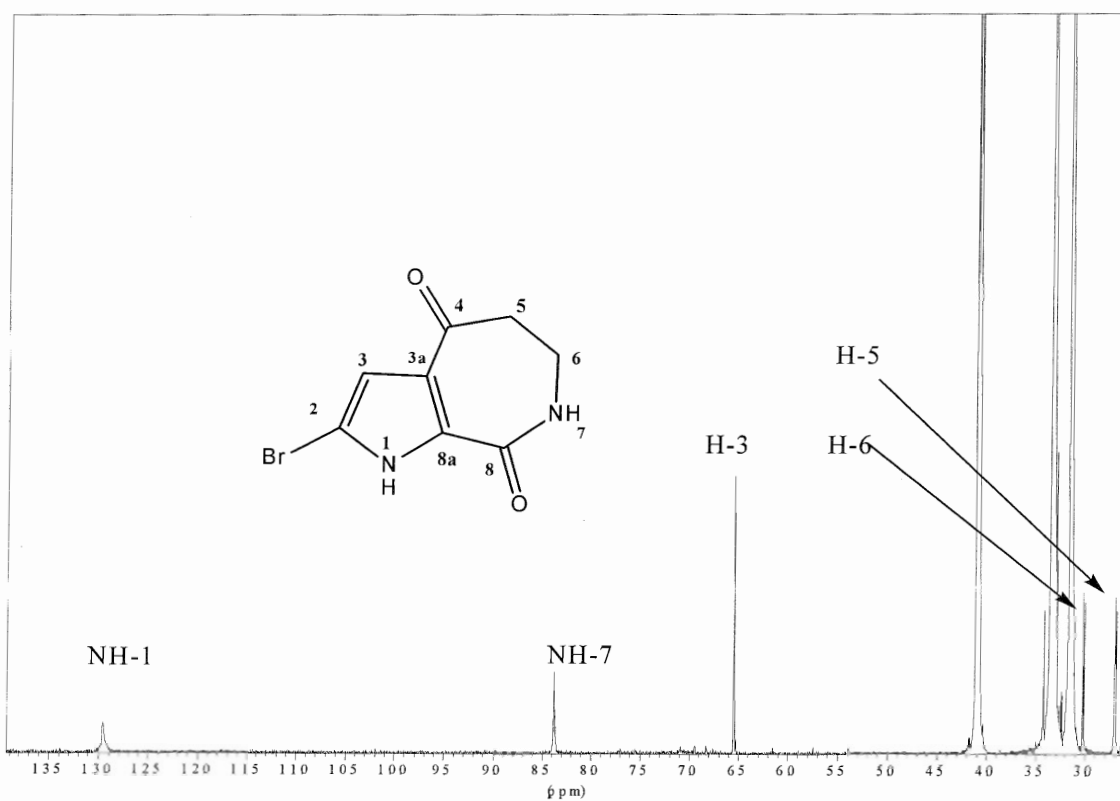

Figure 3.1.2.B: ¹H-NMR spectrum of 2-bromoaldisin (compound 02)

Results

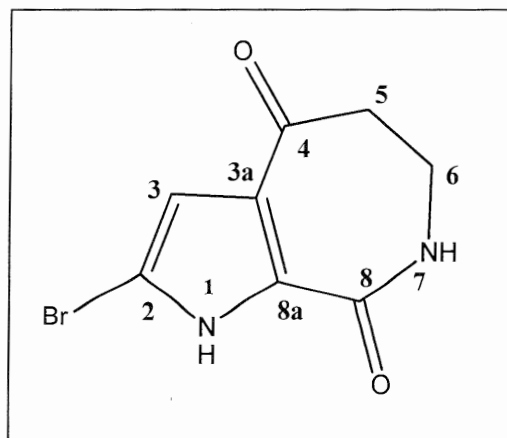

Table 3.1.2.A: ^1H -NMR data of 2-bromoaldisin

H-No.	^1H NMR (ppm), multiplicity (Hz)	^1H NMR (ppm), multiplicity (Hz) 2-bromoaldisin*
H-3	6.51 (1H, s)	6.72 (1H, s)
H-5	2.70 (2H, m)	2.84 (2H, m)
H-6	3.10 (2H, m)	3.55 (2H, m)
NH-1	12.98 (br. s)	-
NH-7	8.48 (br. s)	-

The compound was measured in $\text{DMSO}-d_6$.

* Measured in $\text{CDCl}_3\text{-CD}_3\text{OD}$ 1:1 (Schmitz *et al.*, 1985)

Table 3.1.2.B: ^{13}C -NMR data of 2-bromoaldisin

C-No.	^{13}C -NMR (ppm) of 2-bromoaldisin	^{13}C -NMR (ppm) of 2-bromoaldisin*
C-2	103.0, s	105.7, d
C-3	111.6, d	111.7, d
C-3a	Not detectable	124.9, b.s
C-4	191.5, s	194.3, b.s
C-5	36.7, t	36.5, t
C-6	43.7, t	42.6, t
C-8	160.2, s	159.7, b.s
C-8a	Not detectable	128.3, s

The compound was measured in $\text{DMSO}-d_6$.

* Measured in $\text{CDCl}_3\text{-CD}_3\text{OD}$ 1:1 (Schmitz *et al.*, 1985)

2,3-Bromoaldisin (compound 03)

Chemical name: 2,3-Dibromo-6,7-dihydro-pyrrolo[2,3]azepine-4,8-dione
Character: pale yellow powder **Amount:** 1 mg
Sample code: Stylissa, F2.5 **Molecular weight:** 320/322/324 g / mol
Biological source: marine sponge *Stylissa carteri*
Molecular formula: C₈H₆ Br₂N₂O₂

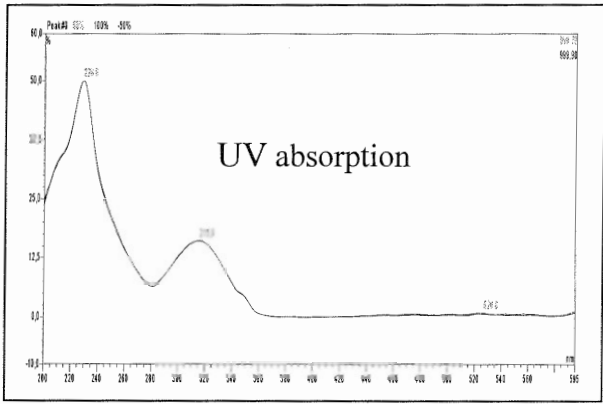
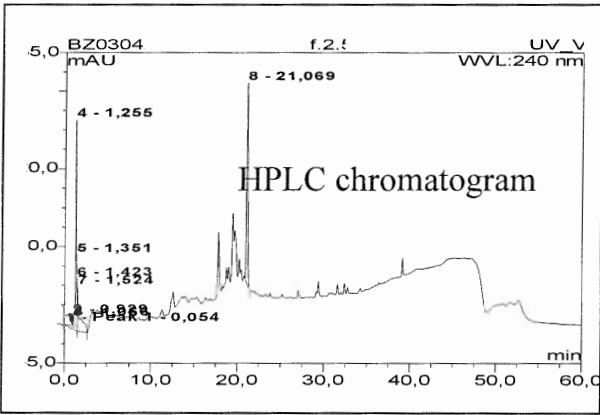
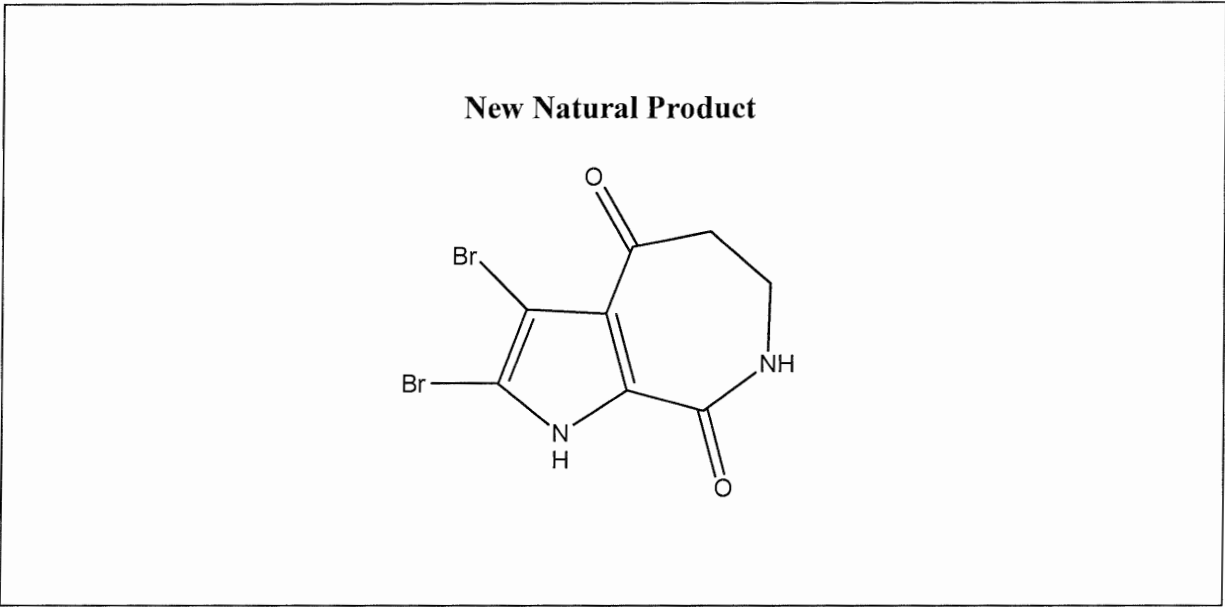

ESIMS: m/z 321/323/325 [M+H]⁺ (Positive)

3.1.3 Structure elucidation of 2,3-bromoaldisin [03].

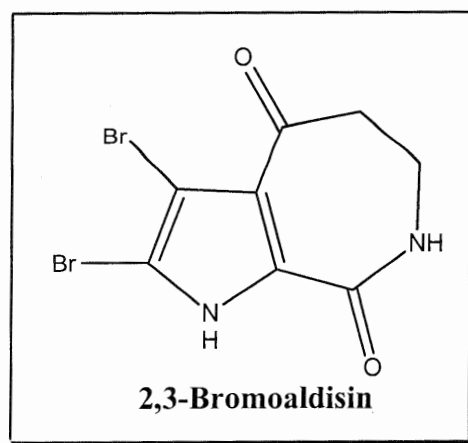

2,3-Bromoaldisin was also isolated by Wafaa Hassan from *Axinella damicornis* (Hassan, 2004). The amount of my compound was added to her compound and a 2-D spectrum was recorded to confirm the structure.

Compound 03 was isolated as a yellow amorphous solid. It has UV absorbances at λ_{\max} 228 and 313 nm. The EIMS spectrum (see Figure 3.1.3.A) showed the molecular ion peak cluster at m/z 320, 322, and 324 in a ratio of 1:2:1, indicating that compound **03** is dibrominated.

In addition, the mass spectral fragmentation pattern with intense ion peaks at m/z 292/294/296 $[M-CO]^+$, 277/279/281 $[M-NH-CO]^+$, 263/265/267 $[M-CH_2-NH-CO]^+$, 249/251/253 $[M-NH-CO-CH_2-CH_2]^+$ suggested an aldisin nucleus (Schmitz *et al*, 1985). This together with the NMR spectra yielded the molecular formula $C_8H_6N_2O_2Br_2$.

The 1H -NMR spectrum (see Figure 3.1.3.B) showed two exchangeable protons at 13.50 and 8.53 ppm for NH-1 and NH-7 respectively, which are identical to those of compounds **01** and **02**. The latter compounds differ from 2,3-bromoaldisin by the absence of the signals at 6.95 and 6.57 ppm like in compound **01**. Furthermore, two multiplet proton signals with the integration of two protons each at 2.75 and 3.33 ppm suggested the presence of two methylene groups in the azepine ring. One of the methylenes is more downfield than the other due to its location near to the nitrogen atom.

The structure of compound **03** was confirmed through inspection of the HMBC spectrum (see Figure 3.1.3.C). It showed correlations of the downfield methylene group to the carbonyl group at 161.5 ppm, the other methylene showing a correlation with the carbonyl group at 193.5 ppm (see Table 3.1.3.A).

Results

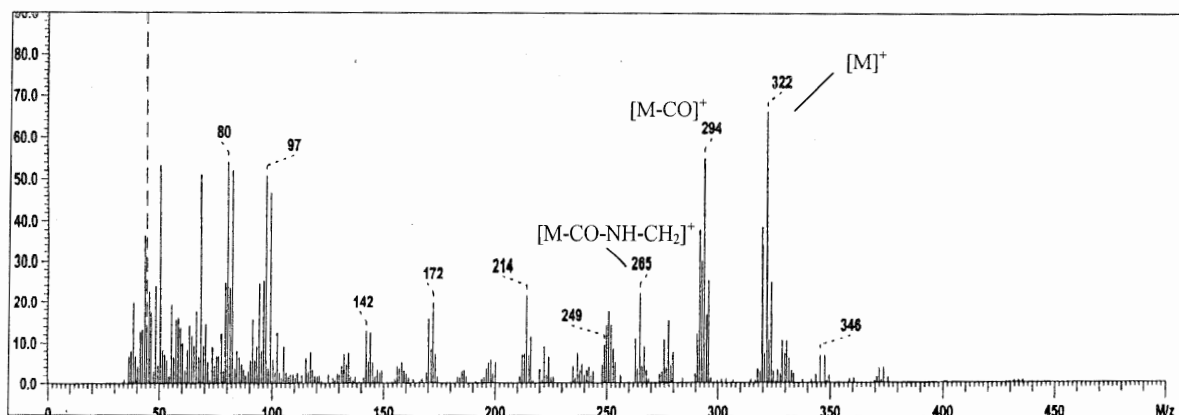

Figure 3.1.3.A: EIMS spectrum of 2,3-bromoaldisin (compound 03)

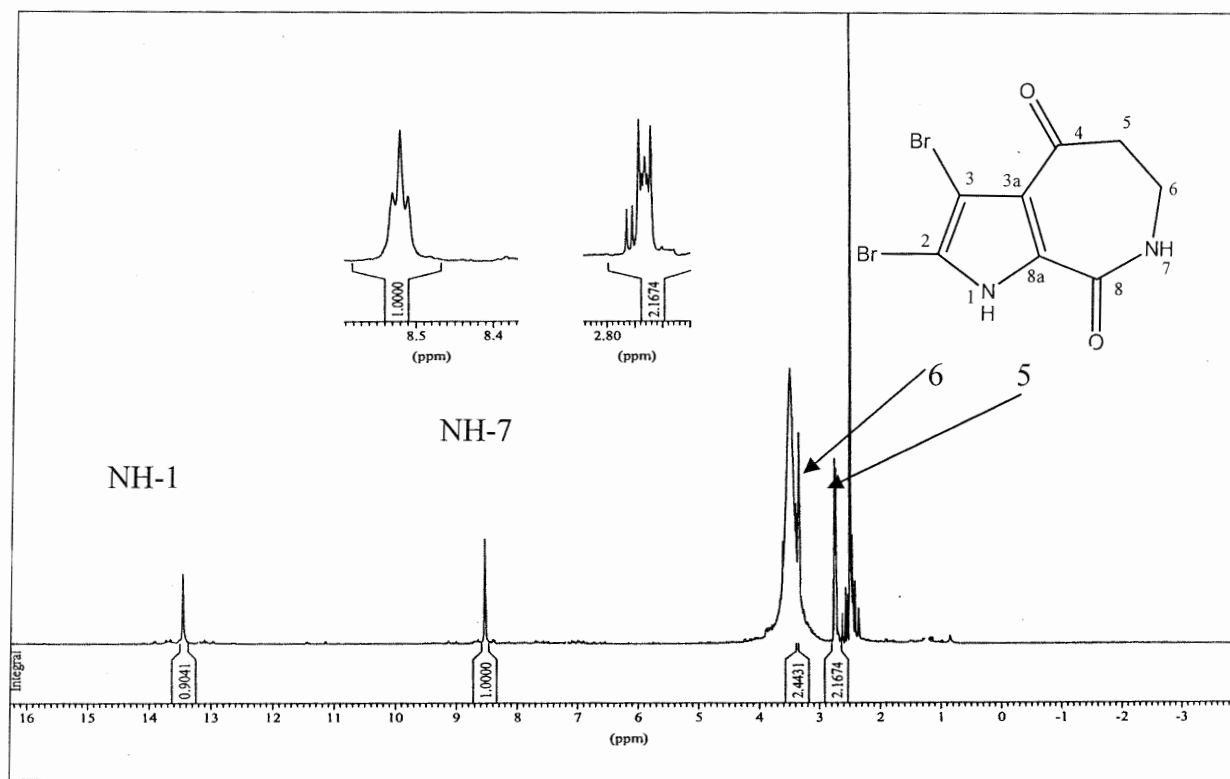

Figure 3.1.3.B: 1H -NMR spectrum of 2,3-bromoaldisin (compound 03)

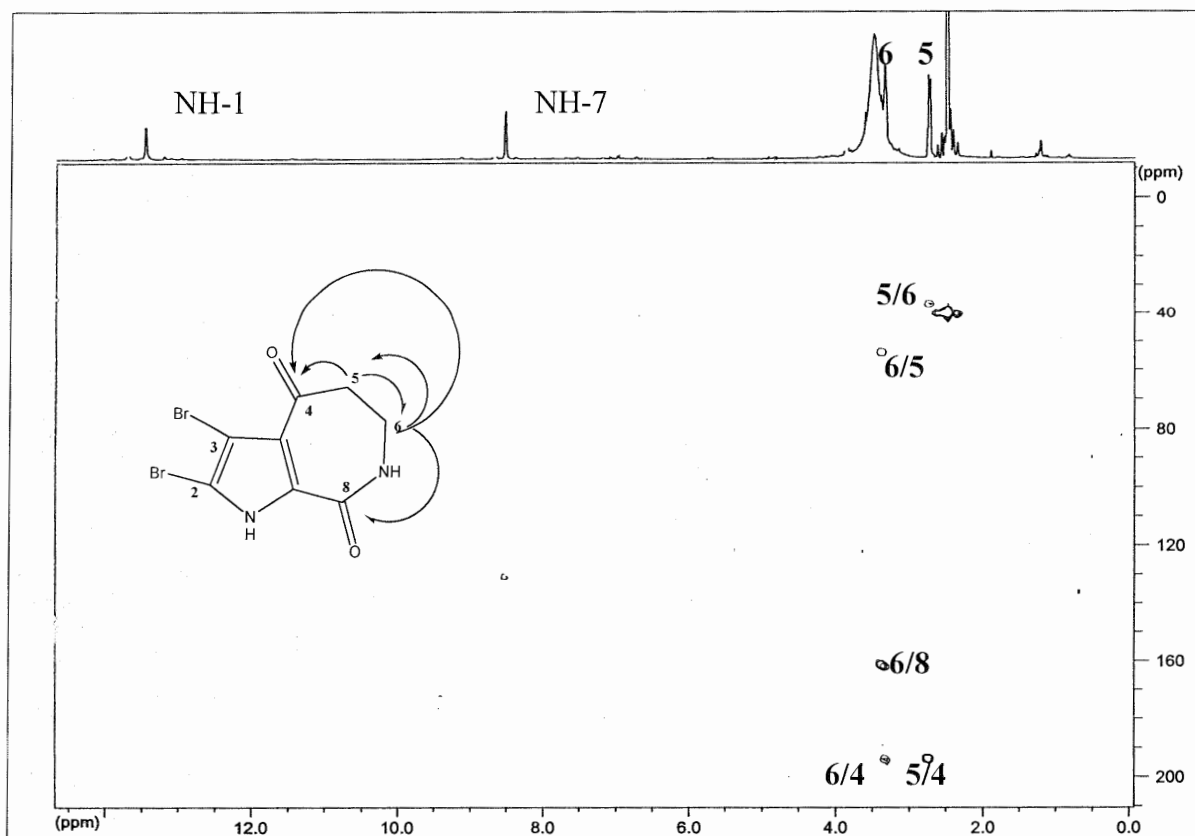

Figure 3.1.3.C: HMBC spectrum of 2,3-bromoaldisin (compound 03)

Table 3.1.4.A: NMR data of 2,3-bromoaldisin (compound 03)

H-No.	¹ H NMR (ppm), multiplicity (Hz)	HMBC
NH-1	13.50, (br, s)	-
H-2	-	-
H-3	-	-
H-4	-	-
H-5	2.75 (2H, m)	4, 6
H-6	3.33 (2H, m)	4, 5, 8
NH-7	8.53 (t, <i>J</i> = 5.0 Hz)	-

The compound was measured in DMSO-*d*₆ at 500 MHz.

Z-Debromohymenialdisin (compound 04)

Chemical name: 4-(2-Hydroxy-5-oxo-imidazolidin-4-ylidene)-4,5,6,7-tetrahydro pyrrole [2,3-c]azepin-8-one

Character: yellow needles

Amount: 15 mg

Sample code: Stylissa, bz1, bz7

Molecular Weight: 245g / mol

Biological source: marine sponge *Stylissa carteri*

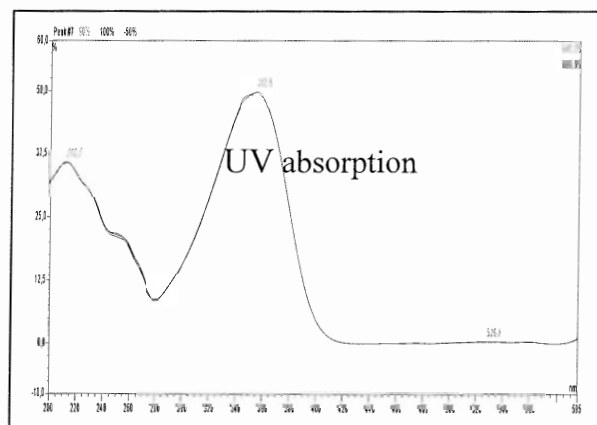
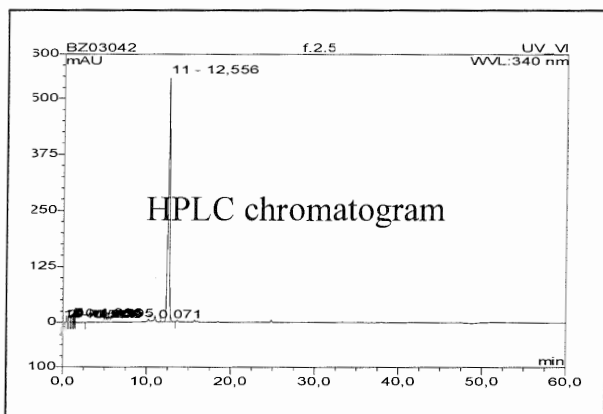
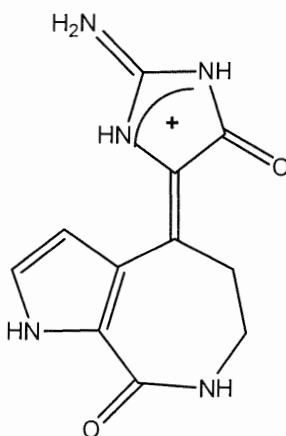

ESIMS: m/z 246 $[M+H]^+$ (Positive)

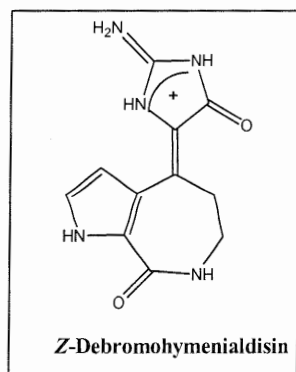
3.1.4 Structure elucidation of *Z*-debromohymenialdisin [04].

Debromohymenialdisin is the major compound of the sponge *Stylissa carteri* collected from the Gulf of Aqaba. It was also isolated from *Phakellia flabellata* (Sharma *et al.*, 1980), *Axinella verrucosa* and *Acanthella aurantiaca* (Cimino *et al.*, 1982).

Compound [4] was isolated as yellow needles. It has UV absorbances at λ_{max} 203, 255 and 360 nm. The ESI-MS spectrum (see Figure 3.3.1.A) gave a peak at m/z 246 $[M+H]^+$. The mass spectrum did not show any bromine cluster, which means that this compound does not have any bromine atom. This together with the NMR spectra and direct comparison with an authentic standard indicated that the compound was debromohymenialdisin.

The ^1H -NMR spectrum showed two downfield triplets at 6.58 and 7.19 ppm, which corresponded to the protons at the pyrrole ring. One broad singlet in the aliphatic region at 3.20 ppm with the integration of four proton is explained by the overlapping of the two methylene groups in the azepin ring (see Table 3.1.4.A).

Two carbonyl singlet carbons at 157.9 and 163.9 ppm in the ^{13}C -NMR spectrum appeared. In addition, there were also observed five more singlet carbons at 121.3, 131.7, 127.0, 119.4 and the downfield carbon 152.9 ppm (carbon carrying amine) and two doublet carbons at 105.8 and 125.8 ppm (see Table 3.1.4.B).

Comparison of the NMR data of compound [04] with the data reported by Eder (Eder *et al.*, 1999) showed that both spectra were very similar, suggesting that the two compounds are identical. This was confirmed by direct chromatographic comparison with the authentic standard.

Results

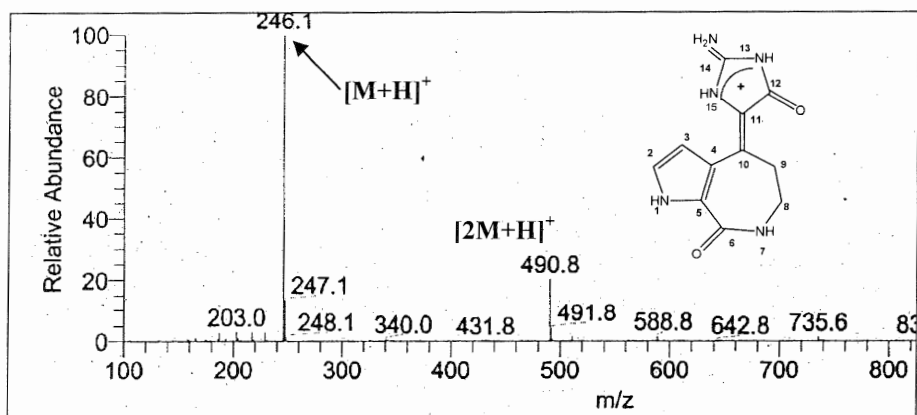

Figure 3.1.4.A: ESI⁺ mass spectrum of *Z*-debromohymenialdisin

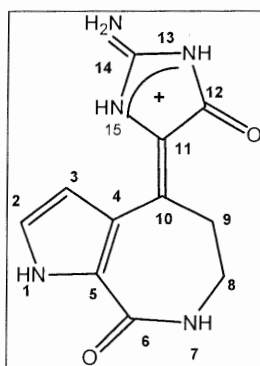

Table 3.1.4.A: ¹H-NMR data of *Z*-debromohymenialdisin

H-No.	¹ H NMR (ppm), multiplicity (Hz) of <i>Z</i> -debromohymenialdisin	¹ H NMR (ppm), multiplicity (Hz) of <i>Z</i> -debromohymenialdisin*
H-2	7.19 (1H, t, <i>J</i> = 2,52 Hz)	7.10 (1H, t, <i>J</i> = 2,52 Hz)
H-3	6.58 (1H, d, <i>J</i> = 2,68 Hz)	6.50 (1H, t, <i>J</i> = 2,52 Hz)
H-8	3.20 (2H, br, s)	3.30 (2H, br, s)
H-9	3.20 (2H, br, s)	3.30 (2H, br, s)
NH-1	11.70 br,s	12.10, br,s
NH-7	7.90 (t, <i>J</i> = 4,73 Hz)	8.00, br,s

The compound was measured in DMSO-*d*₆ at 300 MHz.

* Measured in DMSO-*d*₆ (Eder, 1998)

Table 3.3.1.B: ^{13}C -NMR data of *Z*-debromohymenialdisin

C-No.	^{13}C -NMR (ppm) of <i>Z</i> -debromohymenialdisin	^{13}C -NMR (ppm) of <i>Z</i> -debromohymenialdisin*
C-2	125.8, d	122.6, d
C-3	108.0, d	109.6, d
C-4	119.4, s	120.4, s
C-5	127.0, s	126.7, s
C-6	157.9, s	163.0, s
C-8	41.7, t	39.1, t
C-9	32.4, t	31.5, t
C-10	131.7, s	129.9, s
C-11	121.3, s	120.9, s
C-12	163.9, s	164.3, s
C-14	152.9, s	154.8, s

The compound was measured in $\text{DMSO-}d_6$.

* Measured in $\text{DMSO-}d_6$ (Eder, 1998)

Z-Hymenialdisin (compound 05)

Chemical name: 2-Bromo-4-(2-hydroxy-5-oxo-imidazolidin-4-ylidene)4,5,6,7-tetrahydro-pyrrolo[2,3-c] azepine -8-one

Character: yellow powder

Amount: 7 mg

Sample code: Stylissa, F6.4, F7.1

Molecular Weight: 323/325 g / mol

Biological source: marine sponge *Stylissa carteri*

Molecular formula: C₁₁H₁₁N₅O₂Br

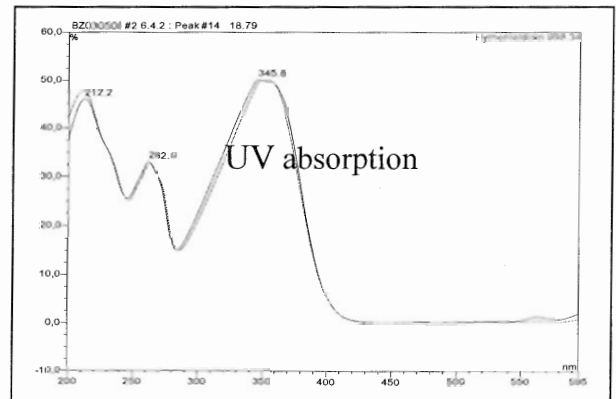
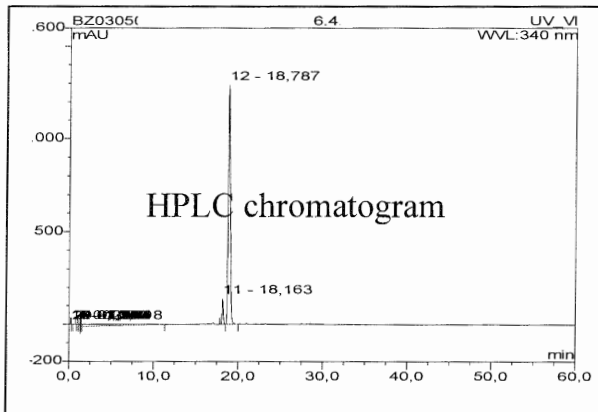
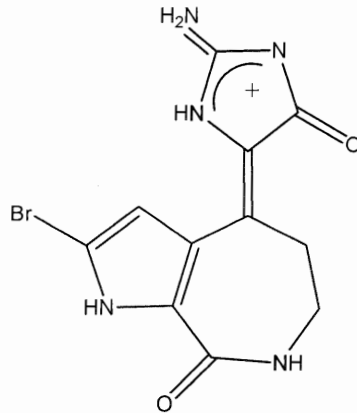

ESIMS: m/z 324/ 326 [M+H]⁺ (Positive)

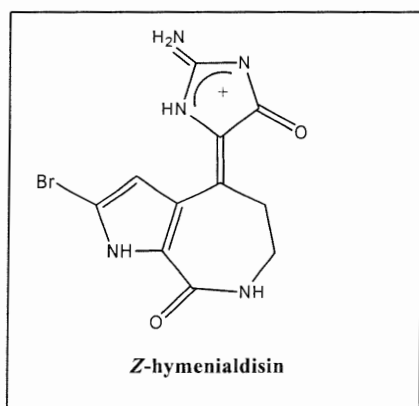
3.1.5 Structure elucidation of *Z*-hymenialdisin [05].

Z-hymenialdisine has been previously isolated from the sponges *Axinella verrucosa*, *Acanthella aurantiaca* and *Hymeniacidon aldis* (Cimino *et al.*, 1982 and Kitagawa *et al.*, 1983) and also from *Stylissa carteri* (Su, 1997 and Eder, 1998).

Compound [05] was isolated as a yellow powder. It has UV absorbances at λ_{max} 212, 262 and 354 nm. The ESI-MS spectrum (see Figure.3.1.5.A) showed the molecular ion peak cluster at m/z 324/ 326 in a ratio of 1:1 corresponding to a monobrominated compound. Seventy eight mass units is the difference between the molecular weights of compound 05 and compound 04 implying the presence of a bromine atom in compound 05. This together with the NMR spectra yielded the molecular formula $C_{11}H_{11}N_5O_2Br$.

The chemical shifts in the $^1\text{H-NMR}$ spectrum (see Figure 3.1.5.B) of compound 05 are very similar to those of compound 04 except of the absence of the downfield proton at 7.19 ppm in compound 04; that was substituted with the bromine atom at C-2 of the pyrrole ring of hymenialdisin. Furthermore it showed four exchangeable protons at 13.02, 8.40 and 6.90 ppm, which were assigned to NH-1, NH-14 and NH-7, respectively, as well as a singlet signal at 3.10 ppm with the integration of four protons arising from the methylene groups CH_2 -8 and CH_2 -9. The four protons of the methylene groups, CH_2 -8 and CH_2 -9 appeared at the same chemical shift due to the anisotropic effect of the carbonyl group at position C-15. Also one downfield singlet signal at 6.59 ppm appeared (see Table 3.1.5.A).

Comparison of the NMR data of compound [05] with the data reported by Eder (Eder *et al.*, 1999) showed that both spectra were very similar, suggesting that the two compounds are identical. This was confirmed by direct chromatographic comparison with the authentic standard.

Results

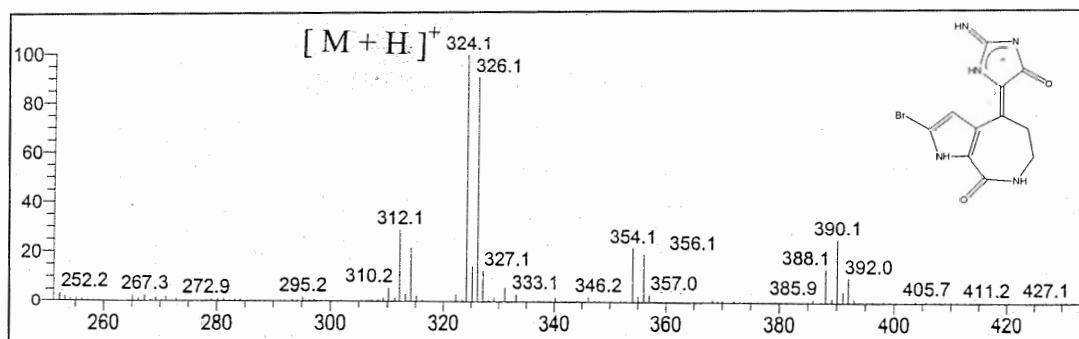

Figure 3.1.5.A: ESI⁺ mass spectrum of compound 05

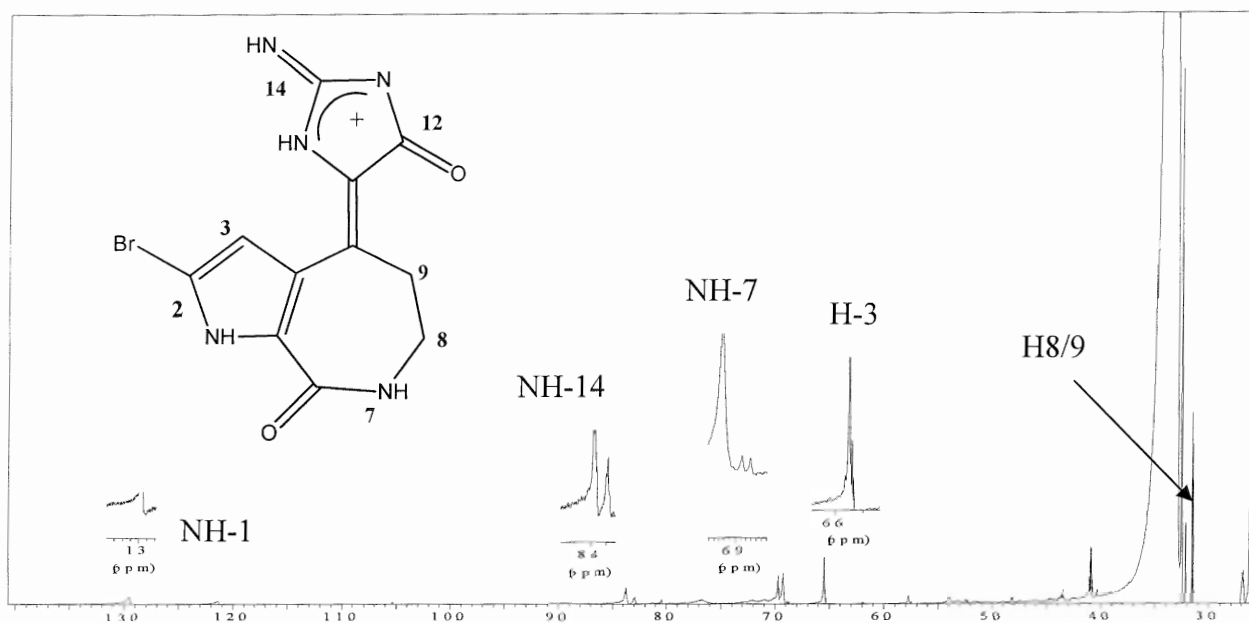

Figure 3.1.5.B: ¹H-NMR spectrum of *Z*-hymenialdisin (compound 05)

Table 3.1.5.A: ¹H-NMR data of *Z*-hymenialdisin (compound 05)

H-No.	¹ H NMR (ppm), multiplicity (Hz) of <i>Z</i> -hymenialdisin	¹ H NMR (ppm), multiplicity (Hz) of <i>Z</i> -hymenialdisin*
NH-1	13.00 (br. s)	12.86 (br. s)
H3	6.59 (1H, s)	6.60 (1H, s)
NH-7	7.00 (br. s)	8.09 (br. s)
H8	3.18 (2H, s)	3.28 (2H, s)
H9	3.18 (2H, s)	3.28 (2H, s)
NH-14	8.40 (br. s)	8.56 (br. s)

The compound was measured in DMSO-*d*₆.

* Measured in DMSO-*d*₆ (Eder, 1998)

3-Bromohymenialdisin (compound 06)

Chemical name: 2,4-Dibromo-4-(2-imino-5-oxo-imidazolidine-4-ylidene)4,5,6,7-tetrahydro-1H-pyrrolo[2,3-c]azepin-8-one

Character: a yellow amorphous solid **Amount:** 3 mg

Sample code: Stylissa, et.f2.5.1 **Molecular weight:** 401/ 403/405 g / mol

Biological source: marine sponge *Stylissa carteri*

Molecular formula: C₁₁H₉N₅OBr₂

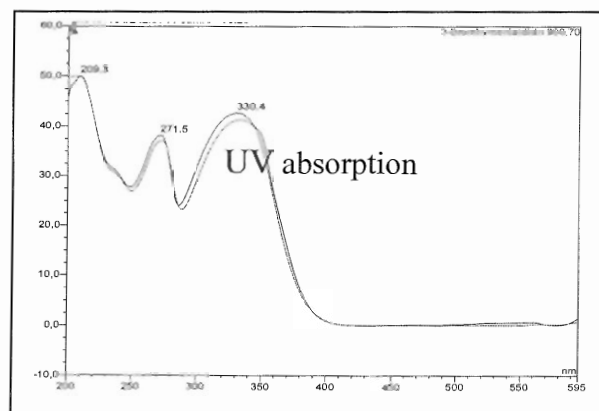
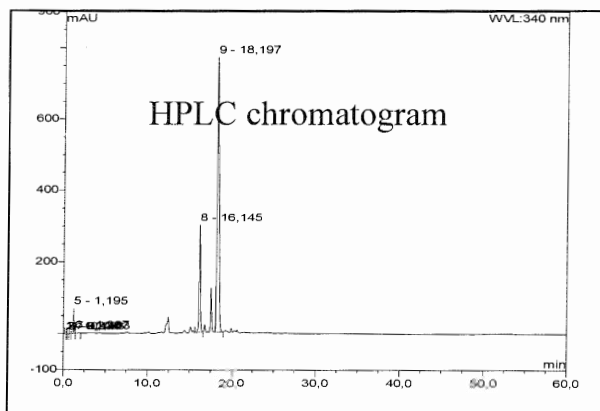
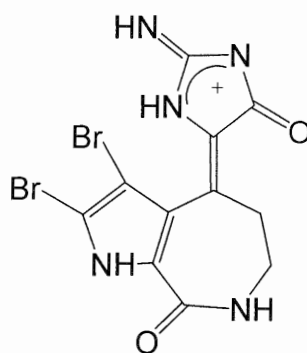

ESIMS: *m/z* 402/ 404/406 [M+H]⁺ (Positive)

3.1.6 Structure elucidation of 3-bromohymenialdisin [06].

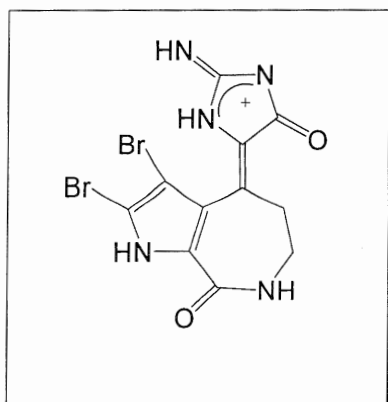

3-Bromohymenialdisin was previously isolated from the sponges *Phakellia flabellata* (Sharma *et al.*, 1980), *Axinella verrucosa*, *Acanthella aurantiaca* (Cimino *et al.*, 1982; Mattia *et al.*, 1982), *Hymeniacidon aldis* (Kitagawa *et al.*, 1983; Schmitz *et al.*, 1985) and *Axinella carteri* (Supriyono, 1997 and Eder, 1998).

3-Bromohymenialdisin was isolated as a yellow amorphous solid. It has UV absorbances at λ_{max} 203, 266, and 339 nm. The ESI-MS spectrum (see Figure 3.1.6.A) showed the molecular ion peak cluster at m/z 402, 404, and 406 in a ratio of 1:2:1 corresponding to a dibrominated compound. Seventy eight mass units is the difference between compound **06** and compound **05** implying the presence of an additional bromine atom in **06**. This together with the NMR spectra yielded the molecular formula $\text{C}_{11}\text{H}_9\text{N}_5\text{O}_2\text{Br}_2$.

The chemical shifts of the ^1H -NMR spectrum (see Figure 3.1.6.B) of compound **06** are very similar to those of compound **05** except for the absence of the downfield proton at 5.95 ppm (H-3) that is present in compound **05**; C-3 is substituted with a bromine atom in compound **06**. Furthermore 3-bromohymenialdisin showed four exchangeable protons at 13.40, 8.10, 7.10 and 6.90 ppm, which were assigned to NH1, NH-7, NH-14 and NH-15 respectively, as well as a singlet signal at 3.10 ppm for the methylene groups CH_2 -8 and CH_2 -9. The four protons of the methylene groups, CH_2 -8 and CH_2 -9 appeared at the same chemical shift due to the anisotropic effect of the carbonyl group at position C-15 (see Table 3.1.6.A).

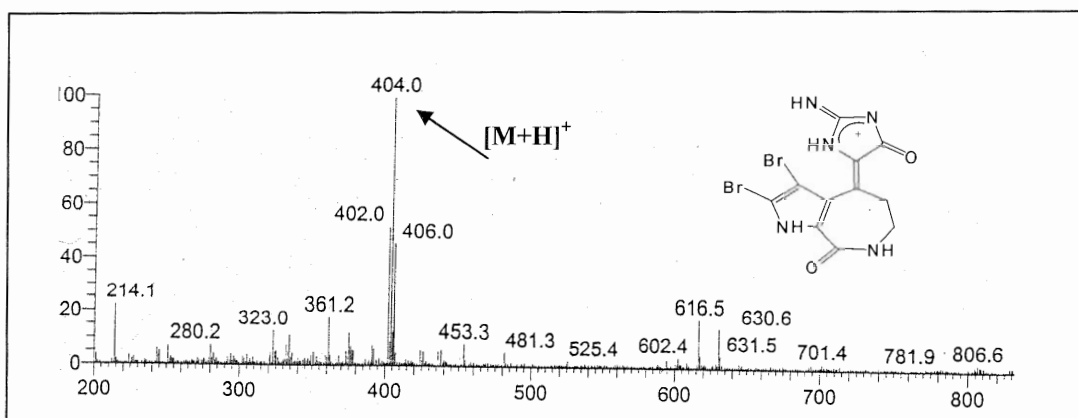

Figure 3.1.6.A: ESI⁺ mass spectrum of 3-bromohymenialdisin

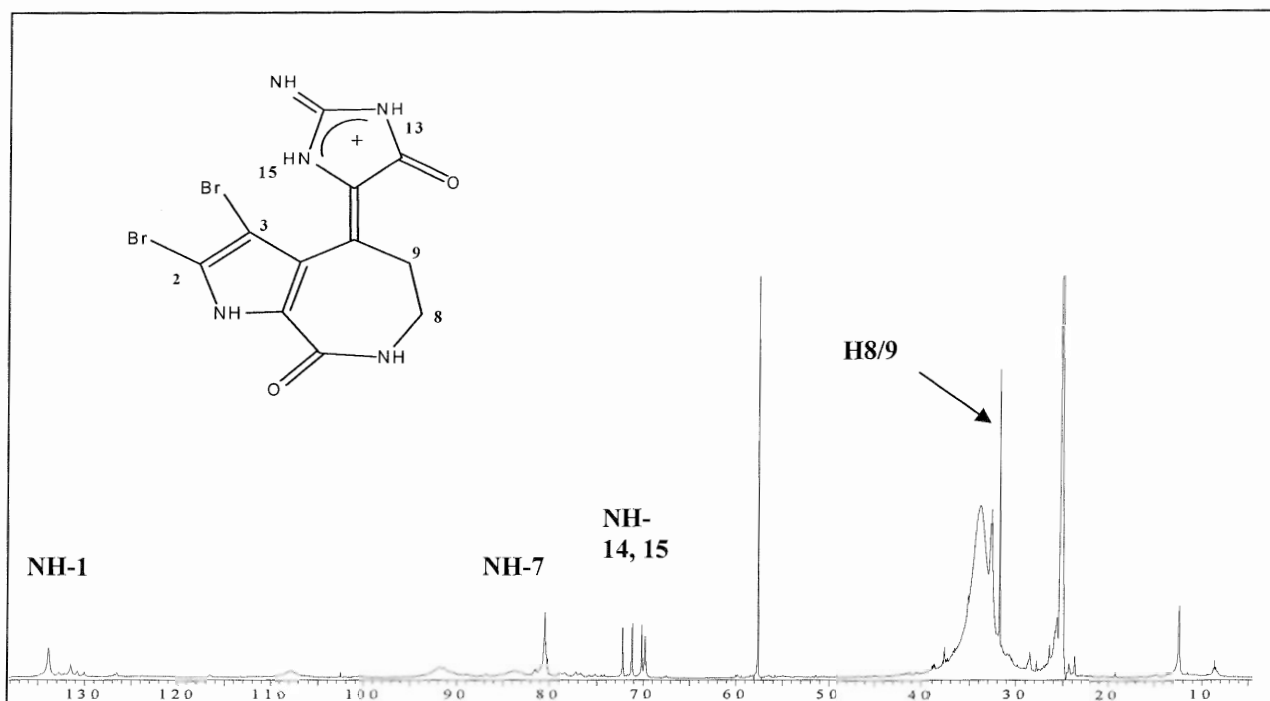

Figure 3.1.6.B: ¹H-NMR spectrum of 3-bromohymenialdisin

Table 3.1.6.B: ¹H-NMR data of 3-bromohymenialdisin

H-No.	¹ H NMR (ppm), multiplicity (Hz) of <i>E</i> -3-bromohymenialdisin
NH-1	13.40 br, s
NH-7	8.10 br, s
H-8	3.10 (2H, s)
H-9	3.10 (2H, s)
NH-14	6.90 br, s
NH-15	7.10 br, s

The compound was measured in DMSO-*d*₆.

Hymenidin (compound 07)

Chemical name: 4-3-[1-(4-Bromo-pyrrol-2-yl)-vinylamino]-propenyl]-1H-imidazol-2-ylamin

Character: yellow amorphous substance **Amount:** 6.5 mg

Sample code: Stylissa, Bu.f3.5

Molecular weight: 309/311 g / mol

Biological source: marine sponge *Stylissa carteri*

Molecular formula: C₁₁H₁₁N₅OBr

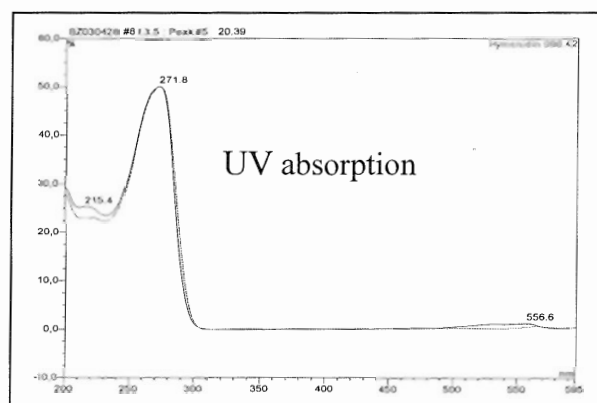
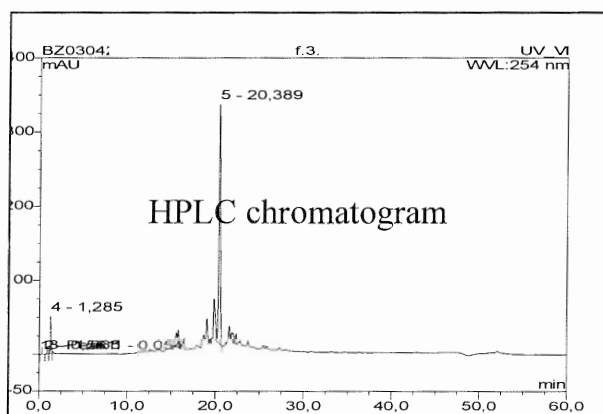
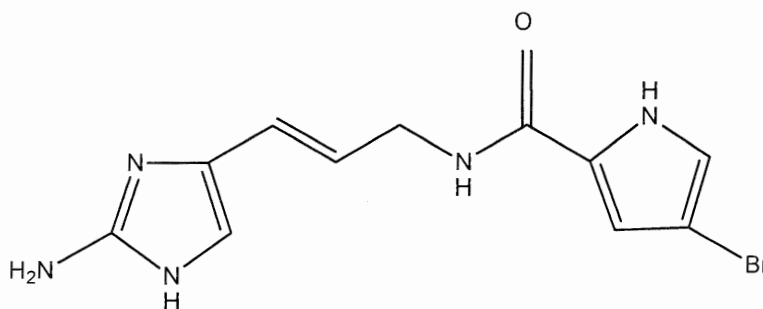

ESIMS: m/z 310/ 312 [M+H]⁺ (Positive)

3.1.7 Structure elucidation of hymenidin [07].

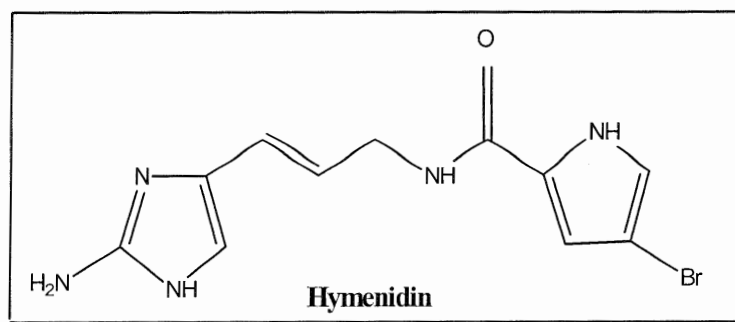

Hymenidin has been previously isolated from the sponges *Axinella verrucosa*, *Acanthella aurantiaca* (Cimino *et al.*, 1982), *Hymeniacidon sp* (Garcia *et al.*, 1973) and from *Stylissa carteri* (Supriyono, 1997 and Eder, 1998).

Compound 07 was isolated as a yellow amorphous substance. It has UV absorbances at λ_{\max} 218 and 271 nm. The ESI-MS spectrum (see Figure 3.1.7.A) gave isotopic clusters at m/z 310 and 312 $[M+H]^+$ in a ratio of 1:1, indicating a monobrominated compound. This together with the NMR spectra suggested the molecular formula $C_{11}H_{11}N_5OBr$.

The ^{13}C -NMR spectrum showed signals at 128.5 (s), 113.7 (d) and 91.1 (s) suggesting the presence of a disubstituted pyrrole ring. This was confirmed from the 1H -NMR spectrum (Fig.3.1.7.B, Table.3.1.7.A) which showed signals at 6.71 (1H, d) and 6.85 (1H, d) corresponding to H-12 and H-14. The resonances at δ_C 123.3 (s), 112.2 (d), 145.5 (s) were assigned to an amino imidazole ring. This was confirmed also from the 1H -NMR signal at 6.70 (1H, s) which was assigned to H-5. The signals at δ_C 127.9 (d), 117.9 (d) for the olefinic carbons H-6 and H-7 were also observed. The remaining 1H -NMR and ^{13}C -NMR signals at 3.96 (2H, dd, 5.36 Hz), 6.15 (1H, dt, 5.36, 16.08 Hz) and 6.25 (1H, d, 15.8 Hz) and at δ_C 42.0 (t), 117.9 (d) and 127.9 (d) indicated the presence of a $CH_2-CH=CH-$ function. The coupling constant values of H-6 and H-7 indicated a *trans*-olefinic function. Correlations between the olefinic protons with the methylene group were observed from the COSY spectrum (see Figure 3.1.7.C).

By careful inspection of the 1H -NMR and ^{13}C -NMR data and by comparison with the literature (Supriyono *et al.*, 1995 and Kobayashi *et al.*, 1986) compound **07** was concluded to be **hymenidin**.

Results

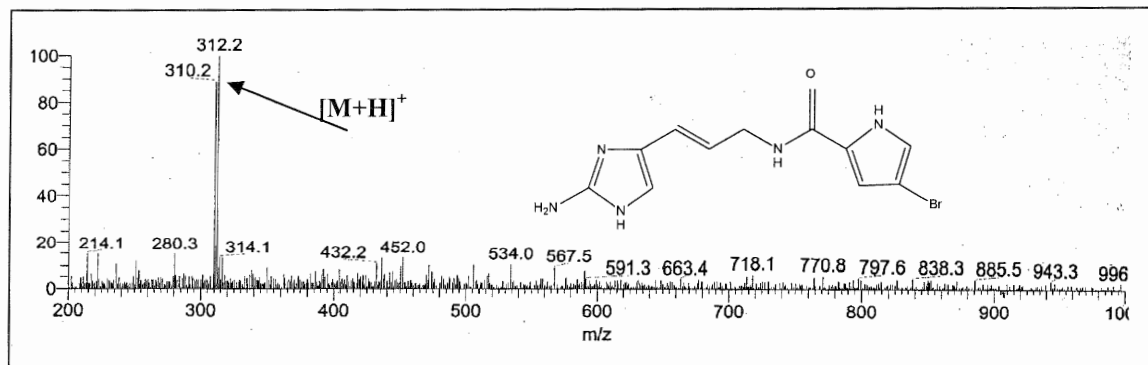

Figure 3.1.7.A: ESI⁺ mass spectrum of hymenidin (compound 07)

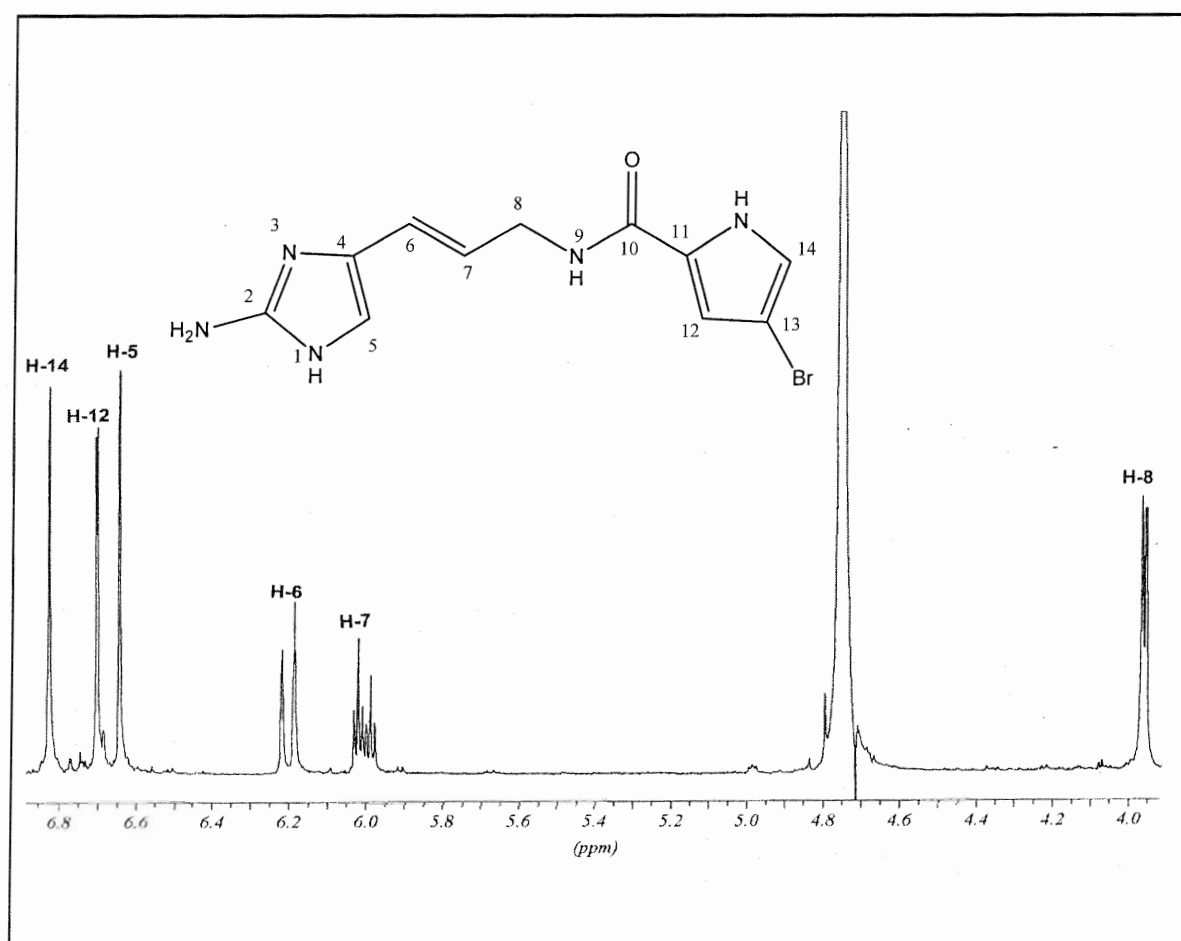

Figure 3.1.7.B: ¹H-NMR spectrum of hymenidin (compound 07)

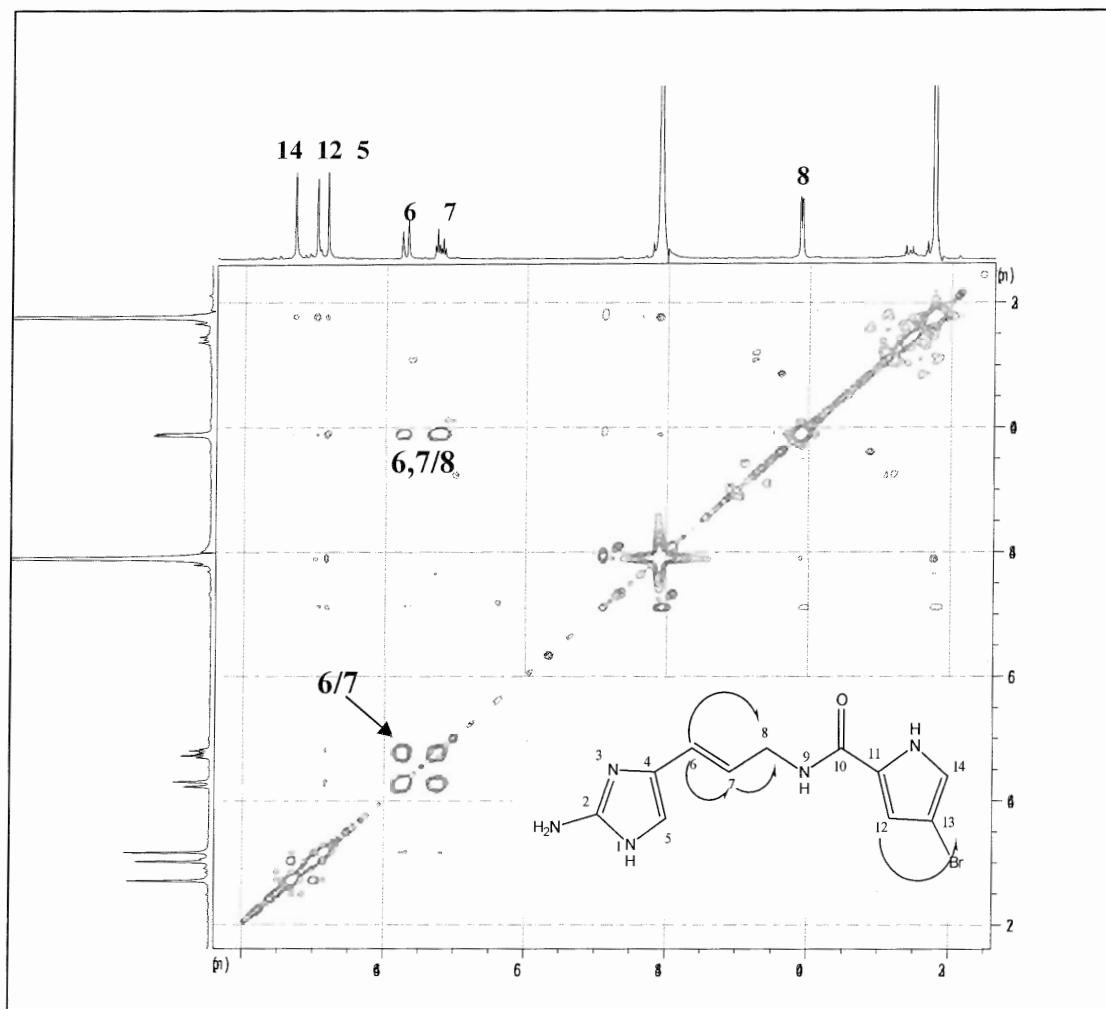

Figure 3.1.7.C: COSY spectrum of hymenidin (compound 07)

Results

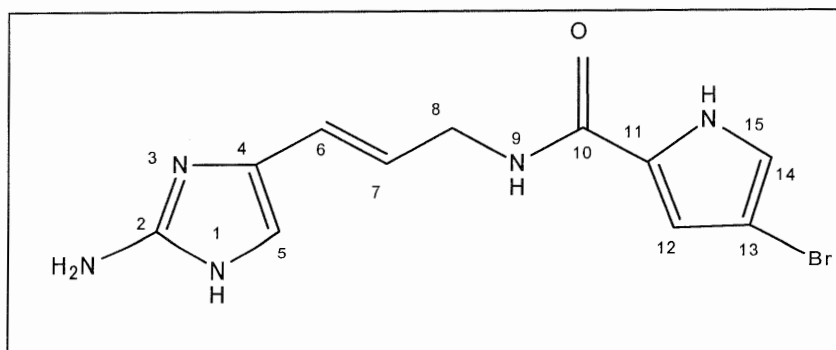

Table 3.1.7.A: ¹H-NMR data of hymenidin (compound 07)

H -No.	¹ H NMR (ppm), multiplicity (Hz)	¹ H NMR (ppm), multiplicity (Hz) hymenidin *
H-5	6.70 (1H, s)	6.87 (1H, s)
H-6	6.25 (1H, d, $J = 16.08$ Hz)	6.22 (1H, d, $J = 16.2$ Hz)
H-7	6.15 (1H, dt, $J = 16.08$ Hz $J_{8-7} = 5.36$ Hz)	6.11 (1H, dd, $J = 16.1$ Hz)
H-8	3.96 (2H, dd, $J_{8-7} = 5.36$ Hz $J_{8-9} = 5.36$ Hz)	3.96 (2H, t, $J_{8-7} = 5.2$ Hz $J_{8-9} = 5.2$ Hz)
**H-12	6.71, (1H, d, $J_{14-12} = 1.57$ Hz)	6.88 (1H, dd, $J_{14-12} = 1.5$ Hz $J_{12-15} = 2.8$ Hz)
**H-14	6.85 (1H, d, $J_{14-12} = 1.57$ Hz)	6.98 (1H, dd, $J_{14-12} = 1.5$ Hz $J_{12-15} = 2.8$ Hz)

The compound was measured in MeOH-*d*₆.

* Measured in DMSO-*d*₆ (Supriyono, 1997).

** Values may be interchangeable.

Table 3.1.7.B: ¹³C-NMR data of hymenidin (compound 07)

C-No.	¹³ C-NMR (ppm) of hymenidin	¹³ C-NMR (ppm) of hymenidin *
C-2	145.5, s	147.7, s
C-4	123.3, s	124.9, s
C-5	112.2, d	111.1, d
C-6	127.9, d	126.7, d
C-7	117.9, d	116.3, d
C-8	42.0, t	39.3, t
C-10	162.9, s	159.5, s
C-11	128.5, s	126.9, s
C-12	113.7, d	111.6, d
C-13	91.1, s	95.0, s
C-14	Not detectable	121.4, d

The compound was measured in MeOH-*d*₆.

* Measured in DMSO-*d*₆ (Supriyono, 1997).

3.1.8 Structure elucidation of 4, 5- dibromopyrrole-2-carbamide [08].

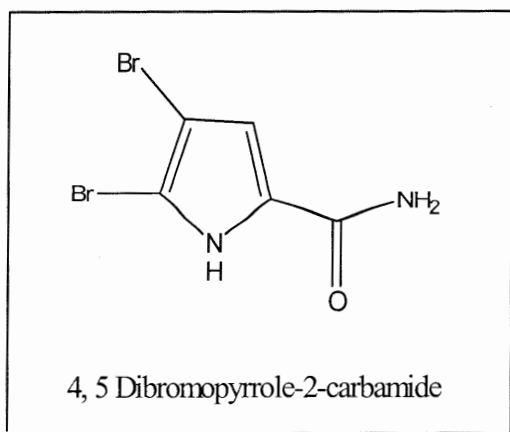

Compound 08 was previously isolated from the sponge *Agelas oroides* (Forenza *et al.*, 1971) and subsequently from *Agelas mauritiana* (Tsukamoto *et al.*, 1996).

It has a UV absorbance at 276 nm. This compound was identified as **4, 5 dibromopyrrole-2-carbamide** based on comparison with the in house spectra library.

3.1.9. The results of biological assays

3.1.9.1 Protein kinase inhibition test

Several of the isolated brominated alkaloids were screened in a protein kinase inhibition assay towards cyclin-dependent kinase-1, cyclin-dependent kinase-5 and glycogen synthase kinase-3. The IC₅₀ values in μM for each compound are reported in Table 3.1.9.1.

Table 3.1.9.1: Results of protein kinase inhibition test.

compound	IC 50 (μM)		
	CDK-1	CDK-5	GSK-3
Debromohymenialdisin	0.54	0.27	0.36
Aldisin	2.8	1	1
3-Bromohymenialdisin	3.7	1.1	0.71
Z-Hymenialdisine	0.45	0.14	0.11
Hymenidin	> 10	> 10	> 10
2,3-Dibromoaldisin	> 10	> 10	> 10

3.2 Indole alkaloids and nucleosides from the sponge *Diacarnus megaspino-rhabdosa*.

Sponges of the genus *Diacarnus* are known to produce terpene peroxides and related metabolites and most of these kinds of compounds have been isolated from *Diacarnus erythraenus* e.g. aikupikoxide A, aikupikoxide B-D, muqubilin, nuapapuin A methyl ester and *O*-methyl guaianediol (see Figure 3.2). Terpene peroxides are a unique class of compounds of both terrestrial and animal origin. Interest has usually focused on such metabolites because of their biological activities; these activities have been associated with antimalarial, antimicrobial, sea urchin egg cell-division inhibitory, antiviral, ichthyotoxic and cytotoxic activities (El.Sayed *et al.*, 2001).

In the present work three nucleosides were elucidated: adenosine, 2-deoxyadenosine and 2-deoxythymidine. In addition, two indole alkaloids were isolated from the sponge.

Currently it was reported that a unique series of simple "unnatural" nucleosides has been discovered to inhibit hepatitis B virus (HBV) replication. Through structure-activity analysis it was found that the 3'-OH group of β -L-2'-deoxyribose of the β -L-2'-deoxynucleoside confers specific anti-hepatovirus activity. The unsubstituted nucleosides β -L-2' deoxycytidine, β -L-thymidine, and β -L-2'-deoxyadenosine had the most potent, selective, and specific antiviral activity against HBV replication. Human DNA polymerases (α , β , and γ) and mitochondrial function were not affected. In the woodchuck model of chronic HBV infection, viral load was reduced by as much as 10^8 genome equivalents/ml of serum and there was no drug-related toxicity. In addition, the decline in woodchuck hepatitis virus surface antigen paralleled the decrease in viral load. These investigational drugs, used alone or in combination, are expected to offer new therapeutic options for patients with chronic HBV infection (Bryant *et al.*, 2001).

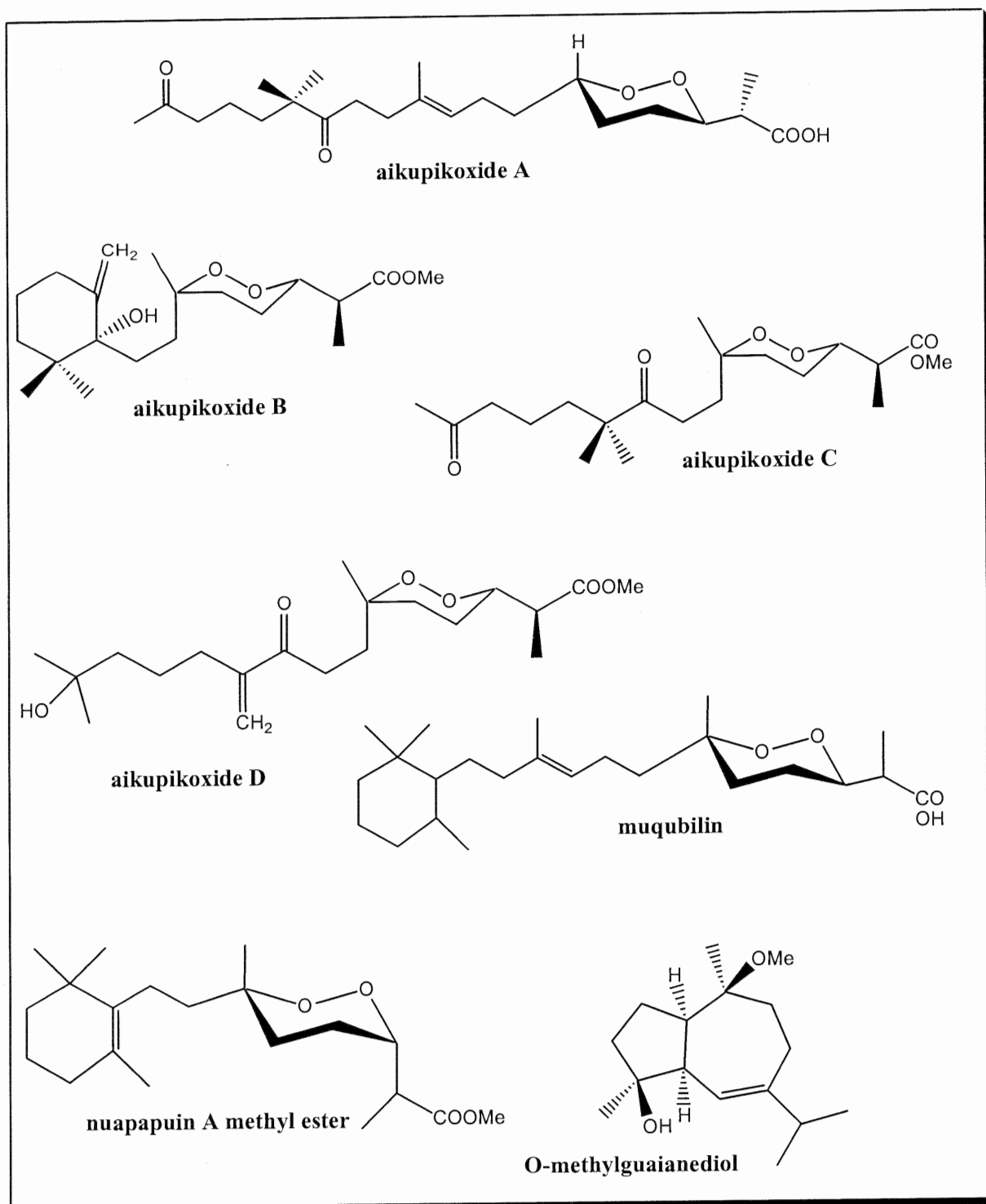

Figure 3.2: Some isolated compounds from *Diacarnus erythraenus*

Indole-3-carbaldehyde (compound 09)

Chemical name: Indole-3-carbaldehyde

Character: yellowish white amorphous powder **Amount:** 3mg

Sample code: TM63 F.8/2

Molecular weight: 145g / mol

Biological source: marine sponge *Diacarnus megaspinorhabdosa* (TM-63)

Molecular formula: C₉H₇NO

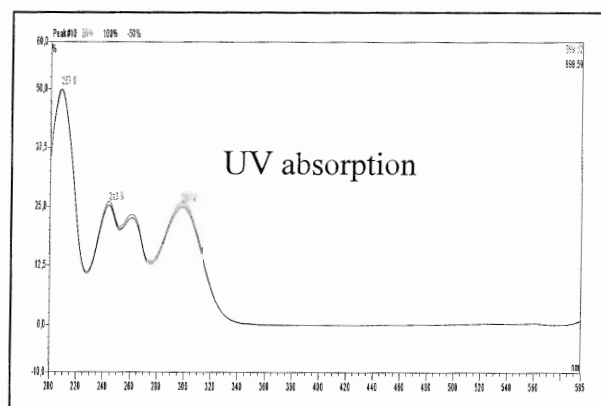
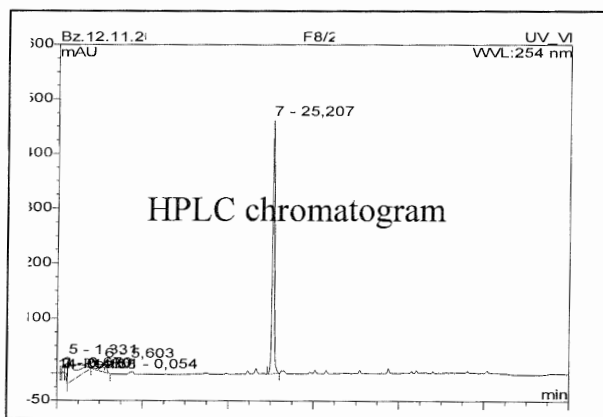
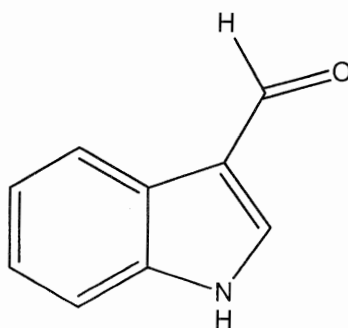

ESIMS: m/z 146 [M+H]⁺ (Positive)

3.2.1 Structure elucidation of indole-3-carbaldehyde [09].

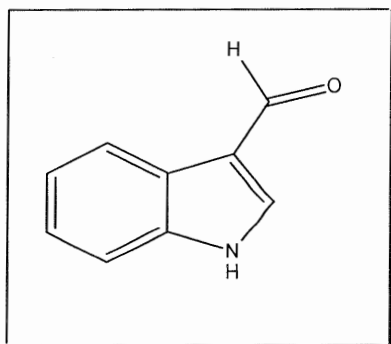

Indole-3-carbaldehyde is a known alkaloid from the stem bark of *Murraya exotica* and from the red alga *Botryocladia leptopoda*. It is also found in barley and tomato seedlings, cotton, *Pseudomonas syringae*, *Rhizobium sp.* and in the coral *Tubastrea coccinea* (Marine Lit., 2003).

Compound 09 was isolated as a yellowish white amorphous powder. It has UV absorbances at λ_{\max} 208, 243 and 297 nm. The ESIMS spectrum showed the pseudo-molecular ion peak at m/z 146 $[M+H]^+$ (see Figure 3.2.1.A). This together with the NMR spectra suggested the molecular formula C_9H_7NO .

The 1H -NMR spectrum (see Figure 3.2.1.B) showed a doublet at 8.15 ppm, two double triplets at 7.29 and at 7.22 ppm (1H, dt) and one doublet at 7.47 ppm (1H, d) indicative for an ABCD aromatic spin system. This revealed the presence of an *ortho*-disubstituted benzene ring. The other singlet signal at 8.09 ppm (1H, s) taken together with the above mentioned signals suggested the presence of a 3-substituted indole. The signal at 9.88 (1H, s) (see Table 3.2.1.A) which was not exchangeable suggested the presence of an aldehydic group. By comparison with data from the literature (Aldrich, 1992) the structure of compound **09** was confirmed.

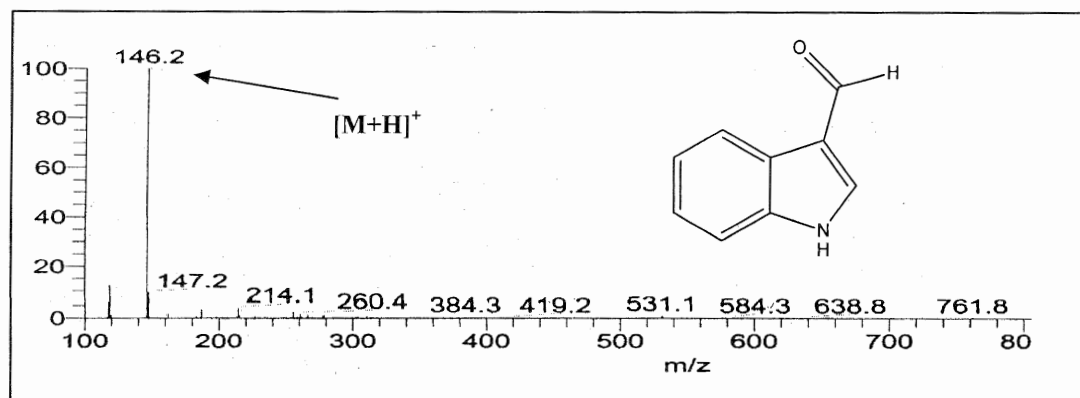

Figure 3.2.1.A: ESI⁺ mass spectrum of indole-3-carbaldehyde

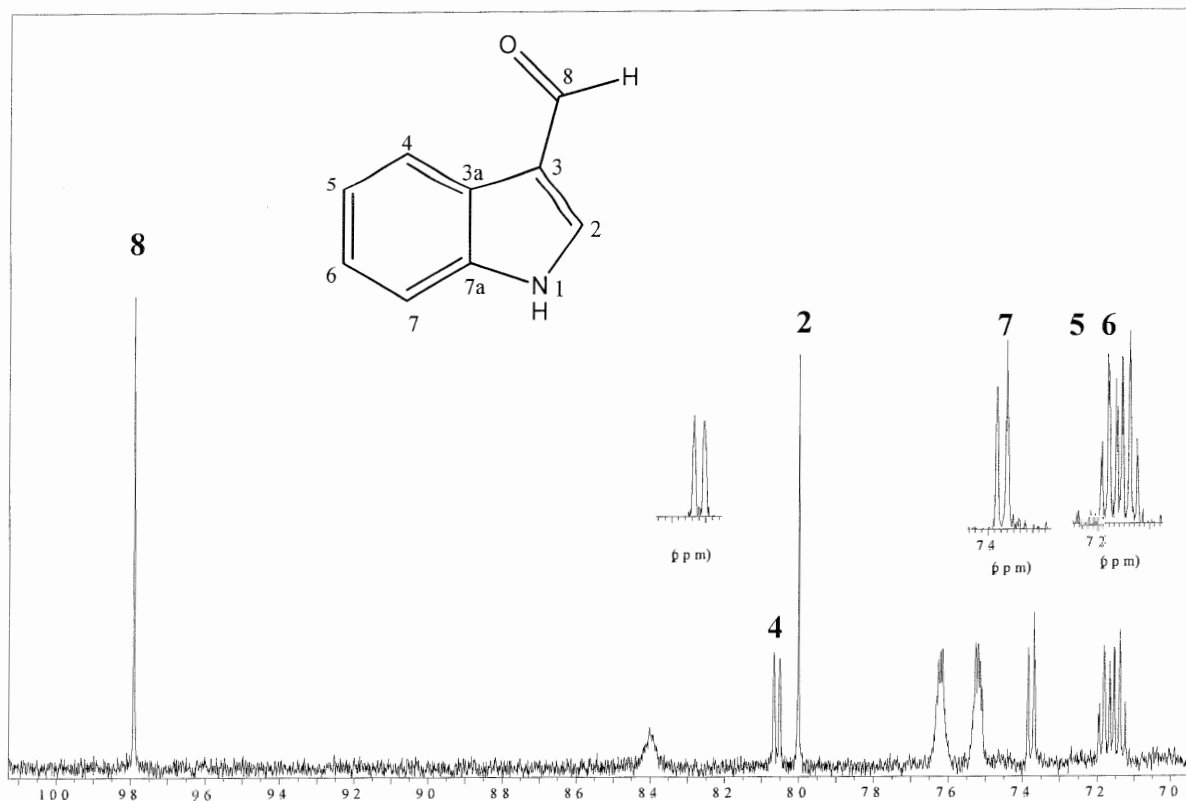

Figure 3.2.1.B: ¹H-NMR spectrum of indole-3-carbaldehyde

Table 3.2.1.A: ¹H-NMR of indole-3-carbaldehyde compound [09]

H-No.	¹ H NMR (ppm), multiplicity (Hz)
H-1	-
H-2	8.09 (1H, s)
H-3	-
H-3a	-
H-4	8.15 (1H, d, $J=7.4$ Hz)
H-5	7.29 (1H, dt, $J=7.4, 2.4$ Hz)
H-6	7.22 (1H, dt, $J=7.4, 2.4$ Hz)
H-7	7.47 (1H, d, $J=7.4$ Hz)
H-7a	-
H-8	9.88 (1H, s)

The compound was measured in DMSO-*d*₆.

Indole-3-carboxylic acid (compound 10)

Chemical name: Indole-3-carboxylic acid

Character: yellowish white amorphous powder

Amount: 4 mg

Sample code: TM63 F.8/2-4

Molecular weight: 161g / mol

Biological source: marine sponge *Diacarnus megaspinorhabdosa* (TM-63)

Molecular formula: C₉H₇NO₂

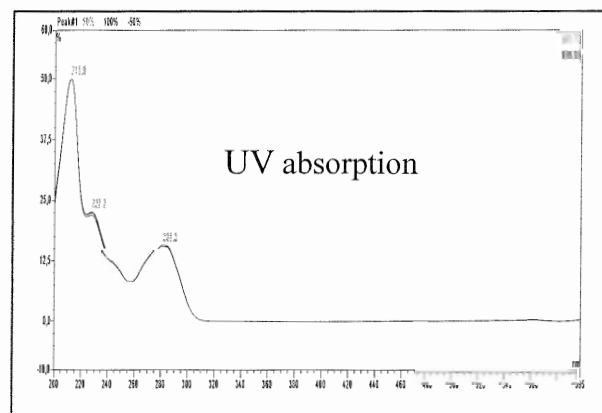
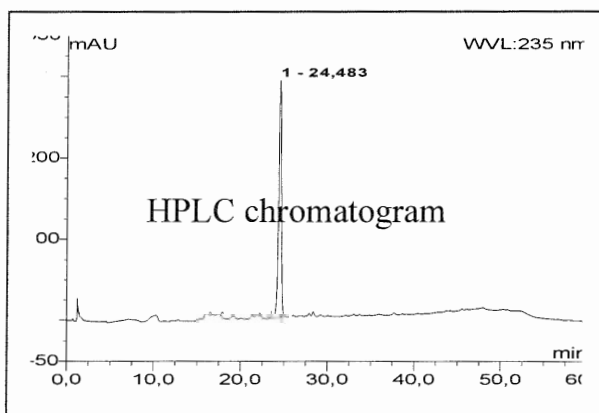
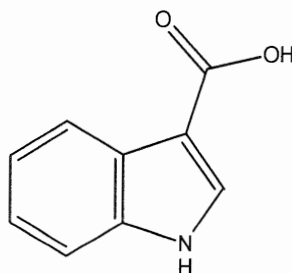

ESIMS: m/z 162 [M+H]⁺ (Positive)

3.2.2 Structure elucidation of Indole-3-carboxylic acid [10].

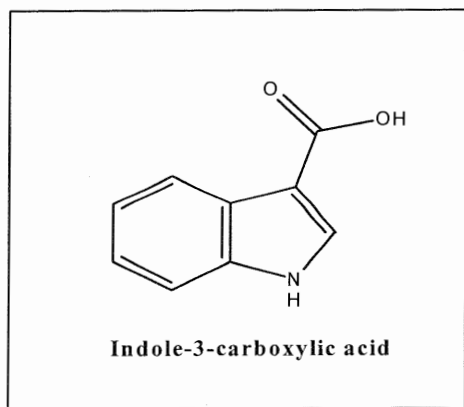

Indole-3-carboxylic acid is an alkaloid derivative present in plants e.g. apple *Pyrus malus*, garden pea *Pisum sativum*, *Brassica sp.* and in the marine algae *Undaria pinnatifida* and *Botryocladia leptopoda*. It is also known from *Verticillium cf. cinnabarinum* (Marine Lit., 2003).

Compound 10 was isolated as a yellowish white amorphous powder. It has UV absorbances at λ_{\max} 218, 232 and 286 nm. The ESIMS spectrum showed the pseudo-molecular ion peak at m/z 162.4 $[M+H]^+$. This together with the NMR spectra yielded the molecular formula $C_9H_7NO_2$.

16 mass units is the difference between compounds **09** and **10**. This difference is explained by the exchange of the aldehydic group by a carboxylic substituent. The 1H -NMR spectrum (see Figure 3.2.2.B) showed a doublet at 8.15 ppm (d, $J = 8.51$ Hz) and signals at 7.1 ppm (1H, dd, $J = 7.94$ Hz), 7.15 ppm (1H, dd, $J = 7.25$ Hz) and 7.42 ppm (1H, d, $J = 7.56$ Hz) being indicative for an ABCD aromatic spin system. This revealed the presence of an *ortho*-disubstituted benzene ring. The other signal at 7.9 ppm (1H, s) suggested the presence of a 3-substituted indole moiety.

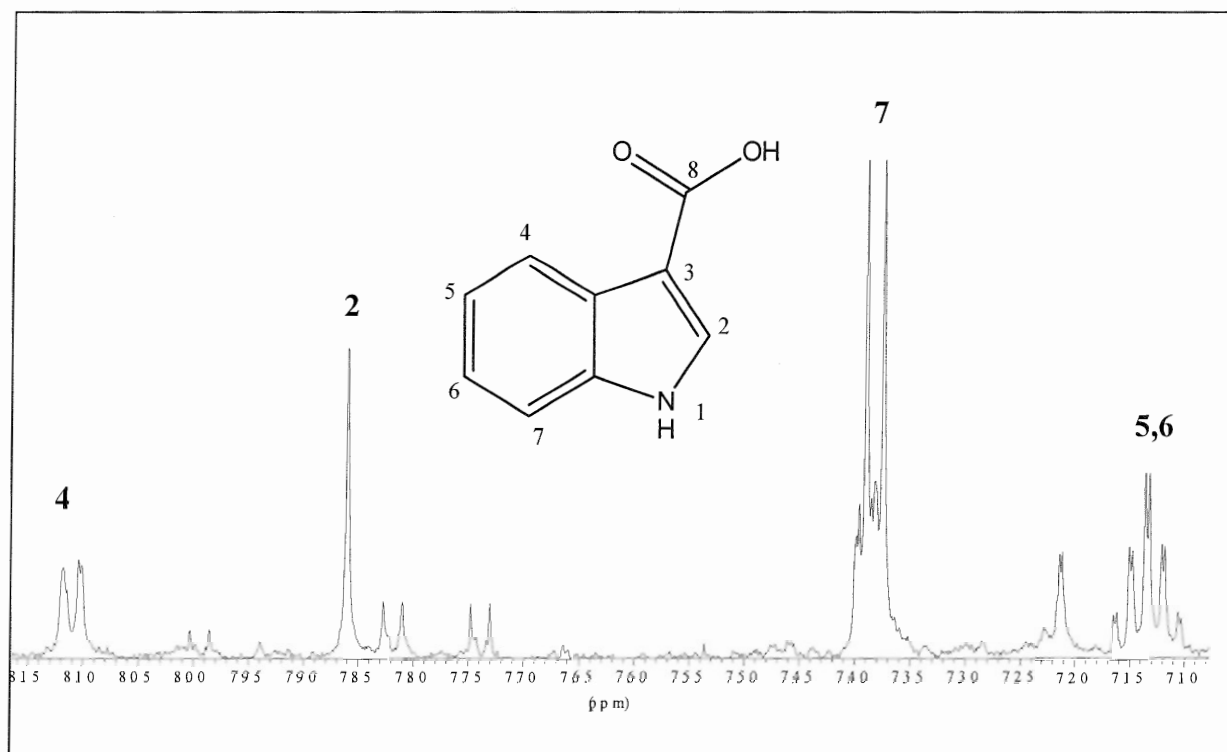

Figure 3.2.2.B: ¹H-NMR spectrum of indole-3-carboxylic acid (compound 10)

Table 3.2.2.A: ¹H-NMR data of indole-3-carboxylic acid (compound 10)

H-No.	¹ H NMR (ppm), multiplicity (Hz)
H-1	-
H-2	7.90 (1H, s)
H-3	-
H-3a	-
H-4	8.15 (1H, d, $J= 8.51$ Hz)
H-5	7.15 (1H, dd, $J= 7.25, 2.40$ Hz)
H-6	7.10 (1H, dd, $J= 7.94, 2.40$ Hz)
H-7	7.42 (1H, d, $J= 7.56$ Hz)
H-7a	-
H-8	-

The compound was measured in MeOH-*d*₆.

Adenosine (compound 11)

Chemical name: 2-(6-Amino-purin-9-yl)-5-hydroxymethyl-tetrahydro-furan-3,4-diol

Character: white powder

Amount: 7 mg

Sample code: TM63 Bu.20-3

Molecular weight: 267g / mol

Biological source: marine sponge *Diacarnus megaspinothabdosia* (TM-63)

Molecular formula: C₁₀H₁₃N₅O₄

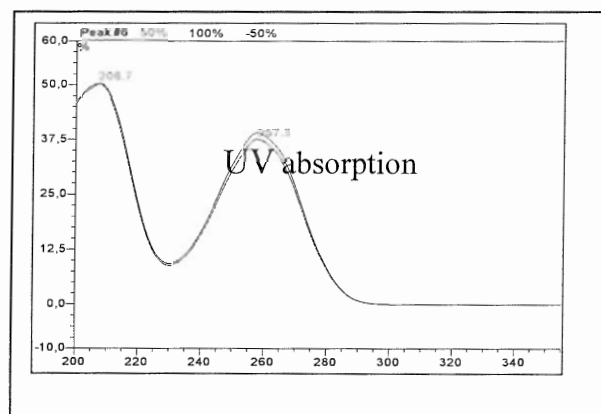
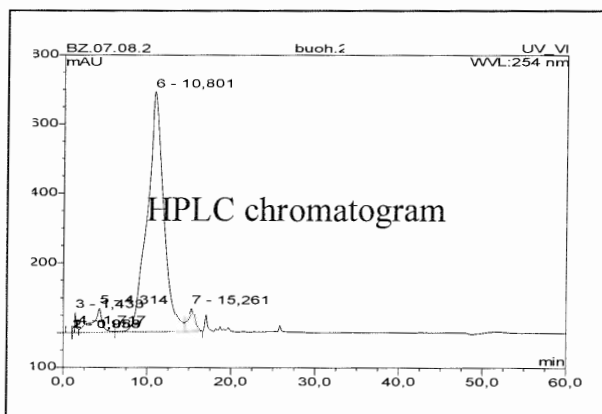
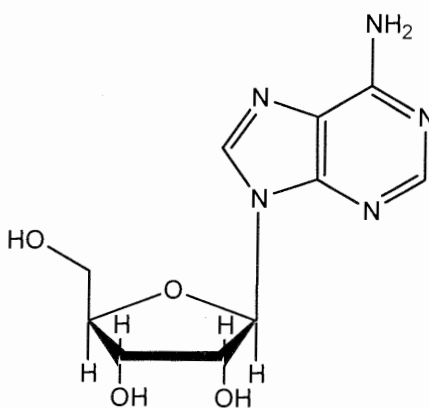

ESIMS: m/z 268 [M+H]⁺ (Positive)

Optical Rotation $[\alpha]_D^{20}$: experiment = -54.0 (c = 0.1, H₂O)
 literature = -60.2 (c = 0.7, H₂O) (Sigma Aldrich, 2003)

3.2.3 Structure elucidation of adenosine [11].

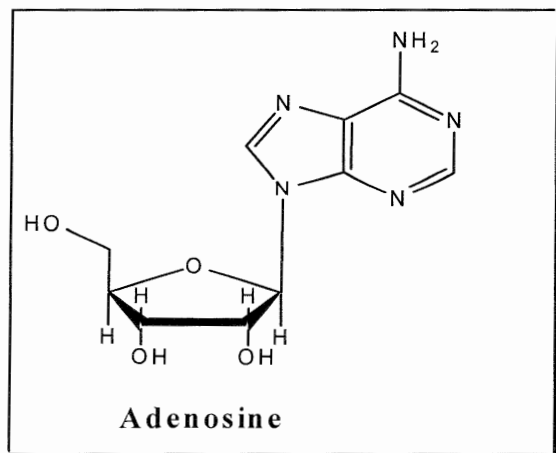

Adenosine is a purine derivative that is widely distributed in nature. It is one of the four principal nucleosides of nucleic acids. Purine and pyrimidine nucleotides are also major energy carriers, subunits of nucleic acids and precursors for the synthesis of nucleotide cofactors such as NAD.

Compound 11 was isolated as a white powder. It has UV absorbances at λ_{\max} 207 and 257 nm. The ESIMS spectrum showed the molecular ion peak at m/z 268.2 $[M+H]^+$ (see Figure 3.2.3.A). This together with the NMR spectra suggested the molecular formula $C_{10}H_{13}N_5O_4$. The 1H -NMR spectrum (see Figure 3.2.3.B) showed two singlet signals in the aromatic region at 8.20 (1H, s) and 8.30 ppm (1H, s) which belong to the two protons in the purine nucleus. The other spin system stands for the ribose sugar and includes the anomeric proton at 5.95 ppm, H4' at 4.32 ppm, H3' at 4.17 ppm and two signals at 3.90 and 3.75 ppm for H5'A,B respectively, and only one H2' signal at 4.75 ppm implying the existence of ribose (see Table 3.2.3.A). The ^{13}C -NMR spectrum (see Table 3.2.3.A) showed the carbons of the ribose sugar at 91.2, 74.0, 72.2, 87.5 and 61.6 ppm.

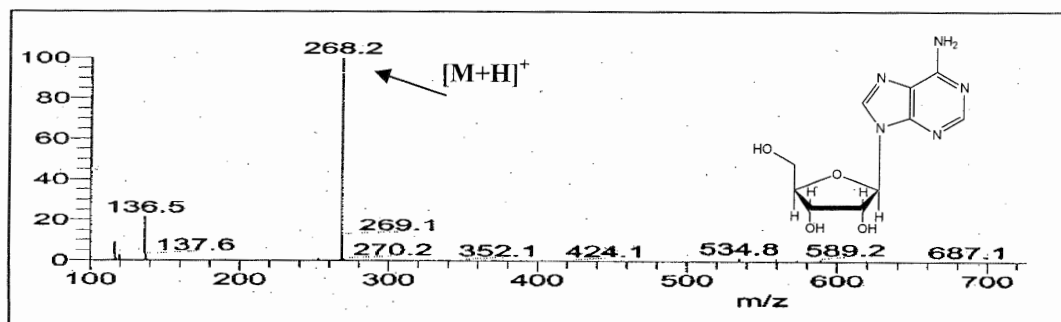

Figure 3.2.3.A: ESI⁺ mass spectrum of compound 11

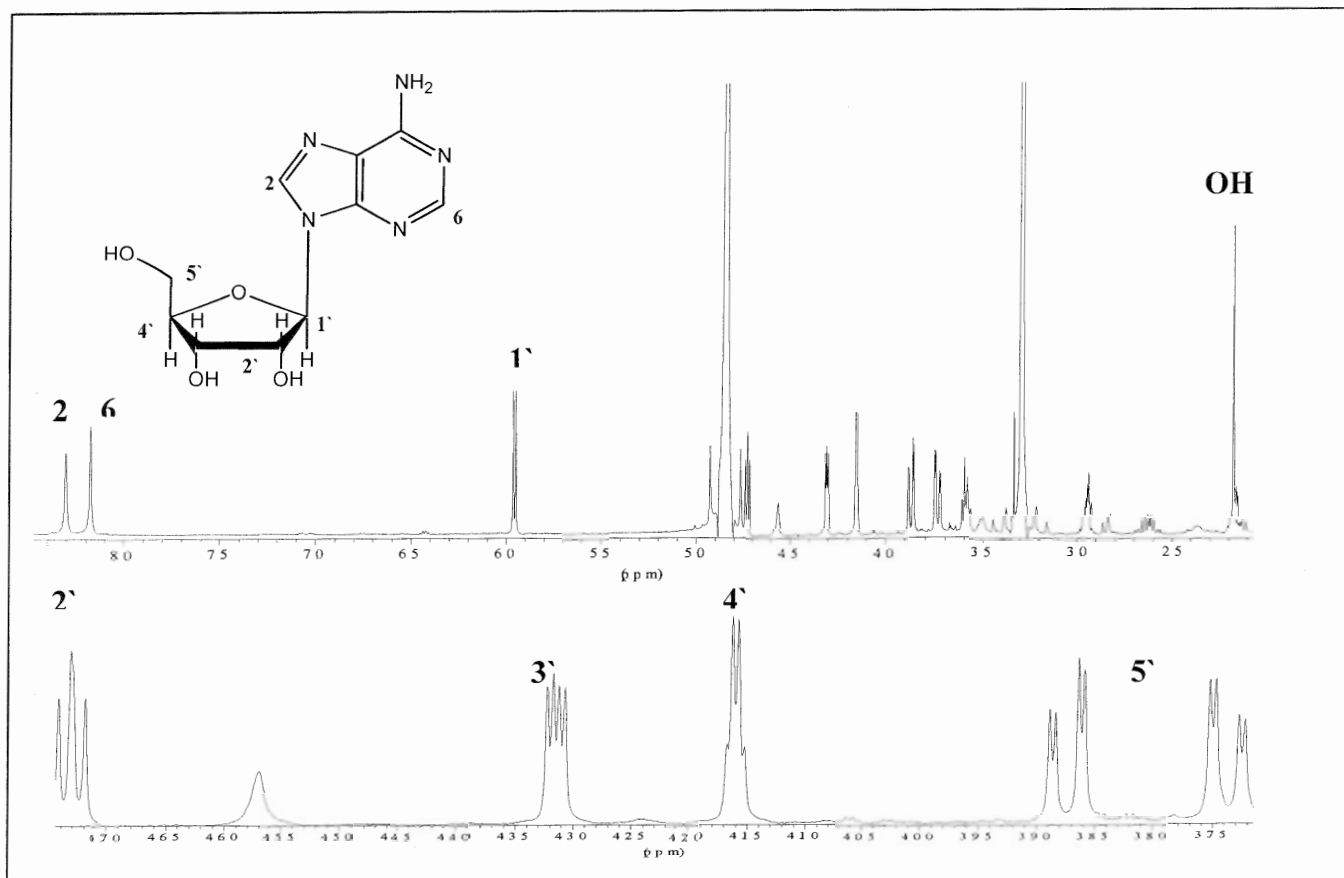
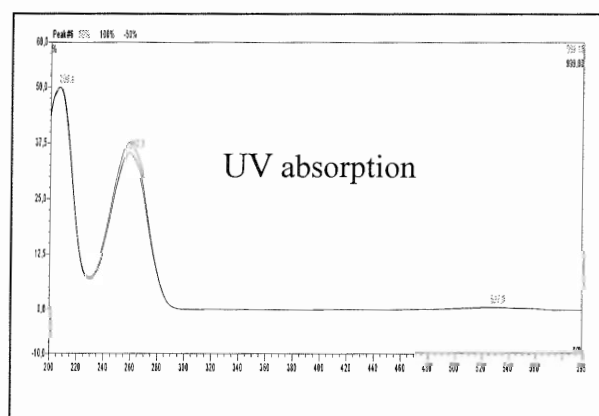
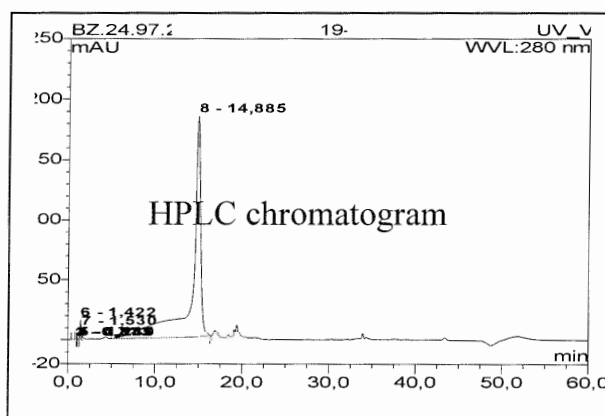
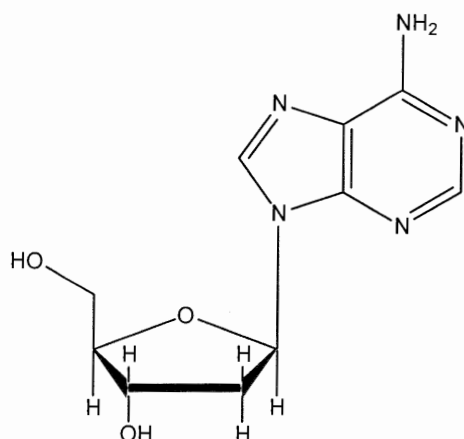

Figure 3.2.3.B: ^1H -NMR spectrum of the compound 11

Table 3.2.3.A: NMR data of compound 11

No	11	
	^1H NMR (ppm), multiplicity (Hz)	^{13}C -NMR (ppm)
2	8.30 (1H, s)	-
3a	-	-
4	-	-
6	8.20 (1H, s)	-
1'	5.95 (1H, d, $J = 6.31$ Hz)	91.2, d
2'	(1H, t, $J = 6.30, 5.36$ Hz)	72.6, d
3'	(1H, dd, $J = 2.52, 5.05$ Hz),	74.0, d
4'	4.32 (1H, dd, $J = 2.84, 5.05$ Hz),	87.5, d
5'A	3.90 (1H, dd, $J = 12.61, 2.84$ Hz)	61.6, t
5'B	3.75 (1H, dd, $J = 12.61, 2.84$ Hz)	61.6, t

The compound was measured in $\text{DMSO-}d_6$.

2-Deoxyadenosine (compound 12)**Chemical name:** 5-(6-Amino-purin-9-yl)-2-hydroxymethyl-tetrahydro-furan-3-ol**Character:** white powder**Amount:** 6 mg**Sample code:** TM63 Bu.sep.19-3**Molecular weight:** 251g / mol**Biological source:** marine sponge *Diacarnus megaspinothabdosia* (TM-63)**Molecular formula:** C₁₀H₁₃N₅O₃**ESIMS:** m/z 252 [M+H]⁺ (Positive)

Optical Rotation $[\alpha]_D^{20}$: experiment = -12.0 (c = 0.1, H₂O)
 literature = -26.0 (c = 0.7, H₂O) (Sigma Aldrich, 2003)

3.2.4 Structure elucidation of 2'-deoxyadenosine [12]

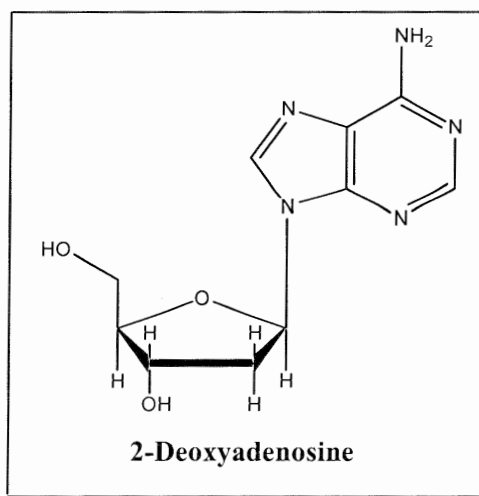

2'-Deoxyadenosine is a purine nucleoside and hydrolysis product of DNA. It was isolated from *Cordyceps sinensis* (Marine Lit., 2003). It is also reported that 2'-deoxyadenosine (2'-dAdo) induces apoptosis in rat chromaffin cells. It is toxic to chromaffin cells of 3-4-week-old rat adrenal glands. More than 75% of the cells plated in culture gradually died over a 3-day period in the presence of 100 μM 2'-dAdo plus 3 μM deoxycytosine (Wakade *et al.*, 1996).

Compound 12 was isolated as a white amorphous powder. It has UV absorbances at λ_{max} 207 and 257 nm. The ESIMS spectrum showed the molecular ion peak at m/z 252.1 $[\text{M}+\text{H}]^+$ (see Figure 3.2.4.A). The mass spectrum showed 16 mass units difference between compound [11] and [12], which is explained by the absence of the hydroxyl group at C-2'. This together with the NMR spectra yielded the molecular formula $\text{C}_{10}\text{H}_{13}\text{N}_5\text{O}_3$.

The ^1H -NMR spectrum (see Figure 3.2.4.B) showed two downfield single signals for the two protons of the purine ring at 8.20 and 8.40 ppm. The other spin system stands for the deoxyribose sugar. It includes the signal of the anomeric proton at 6.45 ppm, and two protons for H2'A,B respectively, at 2.8 and 2.4 ppm implying the absence of a hydroxyl group at C2'. Furthermore, a quartet signal of H3' at 4.55 ppm, H4' at 4.8 and H5'A, B, respectively, at 3.72, 3.82 ppm [2H, dddd, ($J = 2.84, 12.3$ Hz, large geminal coupling)] were observed (see Table 3.2.4.A). The ^{13}C -NMR spectrum (see Figure 3.2.4.C) showed five doublet signals and two triplet signals (see Table 3.2.4.A) that are similar to the spectroscopic data of the previously reported compound (Evidente *et al.*, 1989). It was therefore concluded that both compounds are identical.

Results

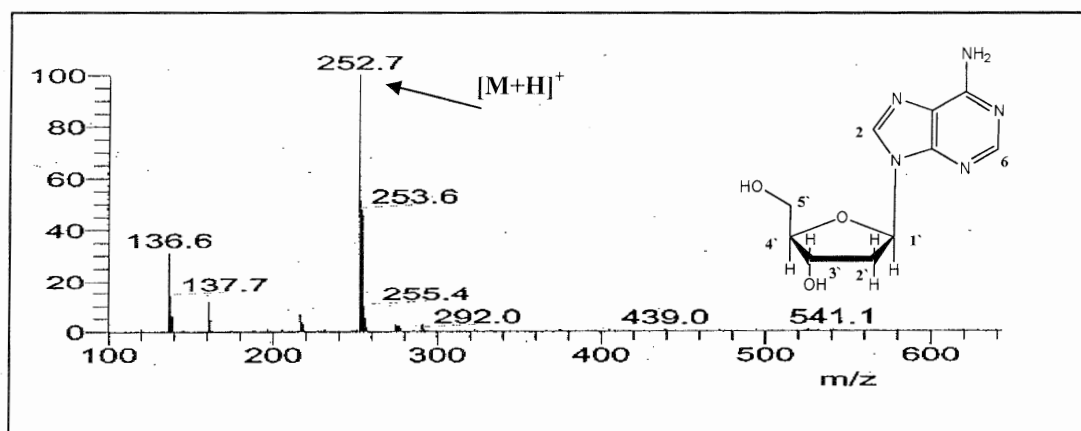

Figure 3.2.4.A: ESI⁺ mass spectrum of 2'-deoxyadenosine

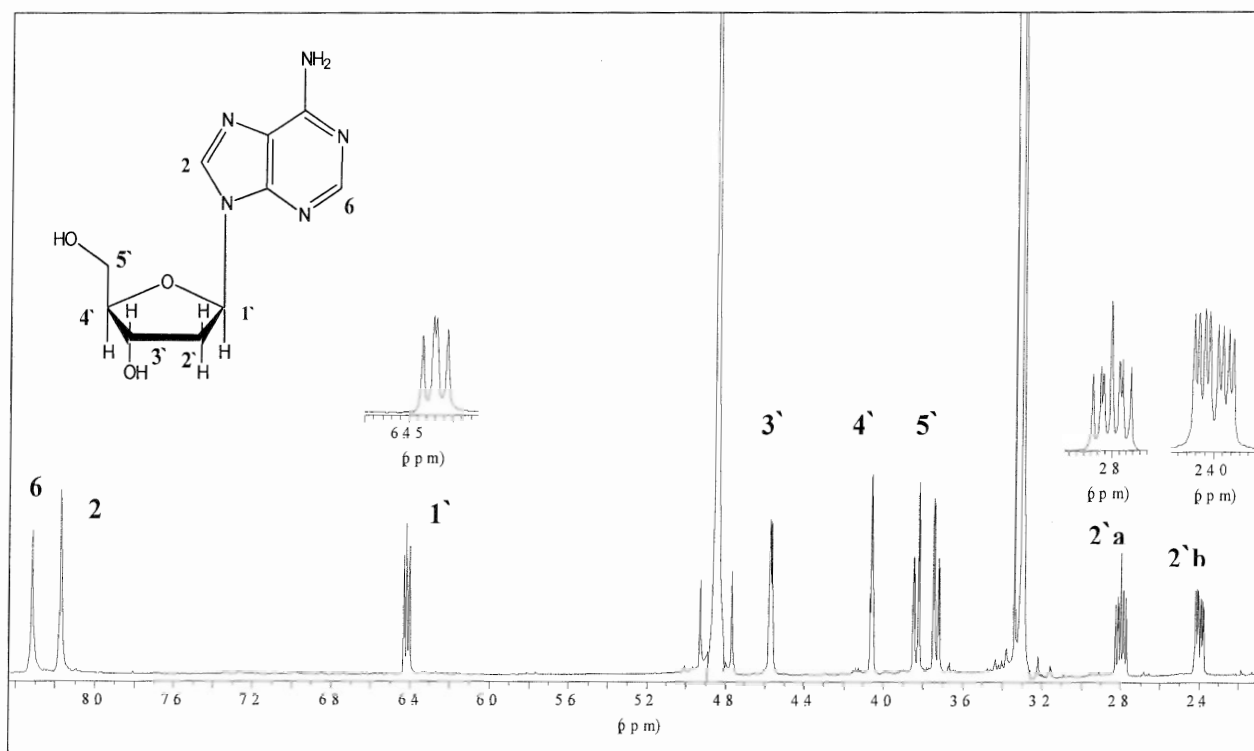

Figure 3.2.4.B: ¹H-NMR spectrum of the compound 12

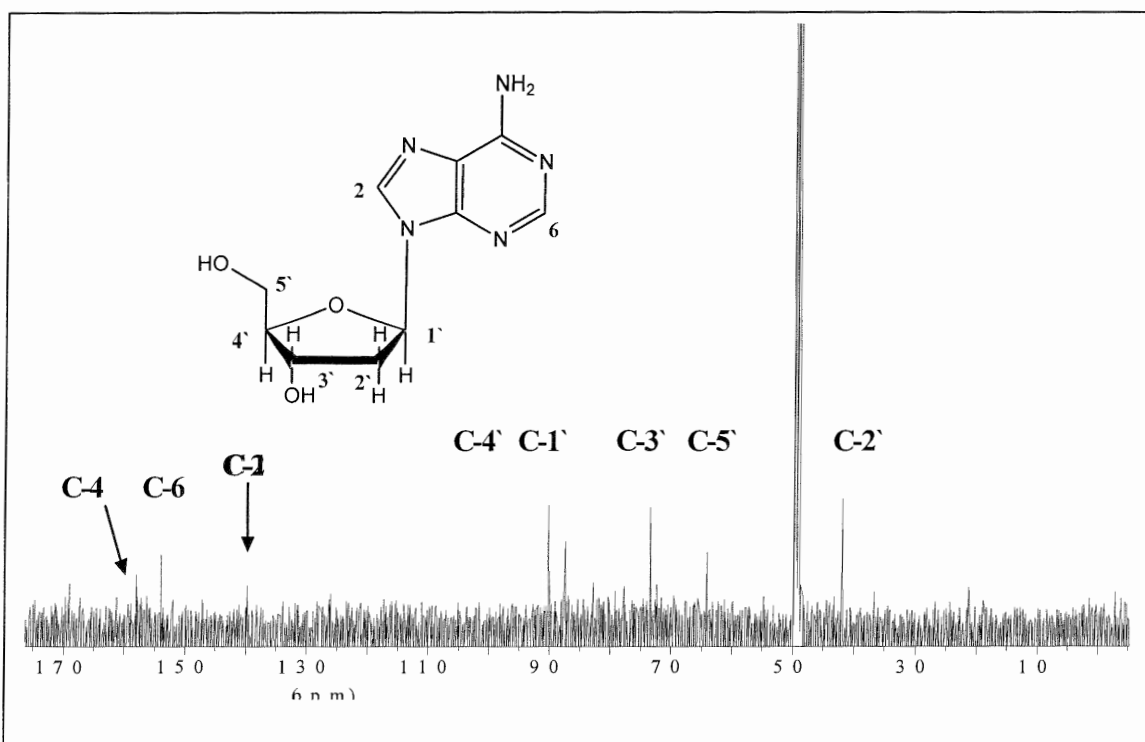

Figure 3.2.4.C: ^{13}C -NMR spectrum of 2'-deoxyadenosine

Table 3.2.4.A: NMR data of compound 12

No	12	
	^1H NMR (ppm), multiplicity (Hz)	^{13}C -NMR (ppm)
2	8.2 (1H, s)	139.4 d
3a	-	-
4	-	157.5 s
6	8.4 (1H, s)	153.5 d
1'	6.45 (1H, dd, $J = 5.99, 7.89$ Hz),	87.1 d
2'A	2.8 (2H, dt, $J_{2'-1'} = 5.99$ Hz, $J_{2'-3'} = 8.19$ Hz)	41.5 t
2'B	2.4 (2H, dt, $J_{2'-1'} = 5.99$ Hz, $J_{2'-3'} = 8.51$ Hz)	
3'	4.55 (1H, q, $J = 2.52, 5.35$ Hz)	73.0 d
4'	4.8 (1H, q, $J = 2.84, 5.68$ Hz)	89.9 d
5'A	3.72 (1H, dd, ($J = 2.84, 12.3$ Hz)	63.6 t
5'B	3.82 (1H, dd, ($J = 2.84, 12.3$ Hz)	63.6 t

The compound was measured in $\text{DMSO-}d_6$.

2'-Deoxythymidine (compound 13)

Chemical name: 1-(4-Hydroxy-5-hydroxymethyl-tetrahydro-furan-2-yl)-5-methyl-1H-pyrimidine-2,4-dione

Character: white powder

Amount: 10 mg

Sample code: TM63 Bu.seph.10

Molecular Weight: 242g / mol

Biological source: marine sponge *Diacarnus megaspinorhabdosa* (TM-63)

Molecular formula: C₁₀H₁₄N₂O₅

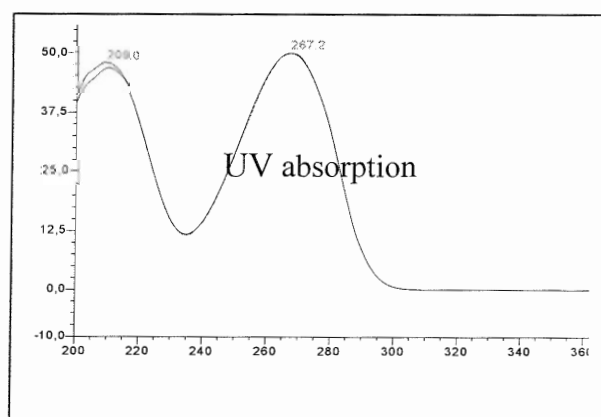
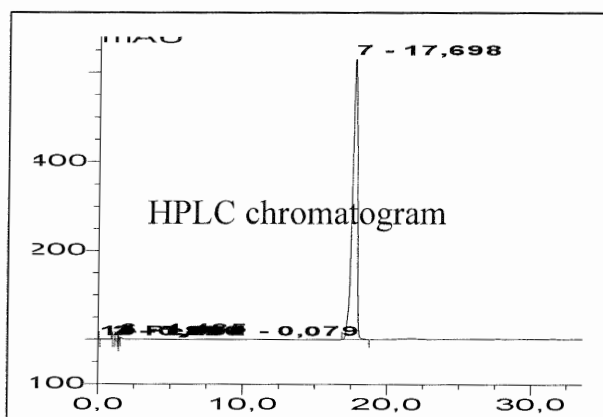
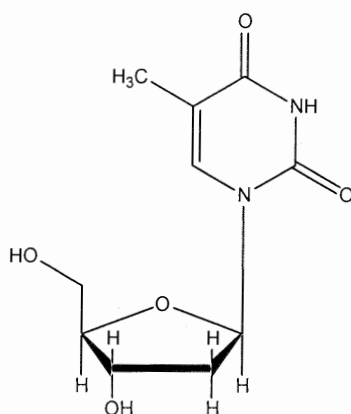

ESIMS: m/z 243 [M+H]⁺ (positive)

Optical Rotation[α]_D²⁰ : experiment = +22.0 (c = 0.1, H₂O)
 literature = +18.0 (c = 0.1, H₂O) (Sigma Aldrich, 2003)

3.2.5 Structure elucidation of 2-deoxythymidine [13]

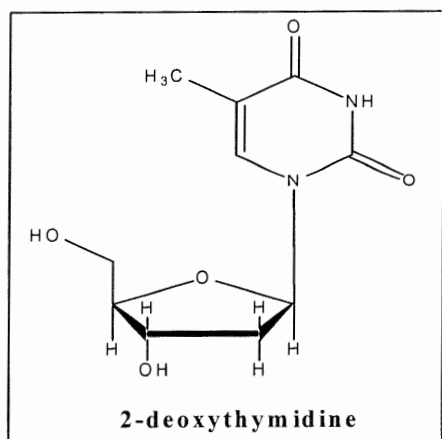

2-Deoxythymidine is 5-methyl-1H-pyrimidine-2,4-dione attached to a deoxyribose sugar. It has been isolated from plant sources e.g. seedlings of *Phaseolus vulgaris* (Marine Lit., 2003). It is also a principal compound of DNA.

Compound 13 was isolated as a white amorphous powder. It has UV absorbances at λ_{\max} 208 and 267 nm. The ESIMS spectrum showed the molecular ion peak at m/z 243.2 $[M+H]^+$ (see Figure 3.2.5.A). This together with the NMR spectra suggested the molecular formula $C_{10}H_{14}N_2O_5$.

The 1H -NMR spectrum (see Figure 3.2.5.B) showed only one signal in the aromatic region at 7.68 ppm (1H, s) which belongs to the proton of the pyrimidine ring. A double doublet signal at 6.15 ppm indicates of the anomeric proton theolefinic methyl group at 1.79 ppm is more downfield than usual due to the presence of the neighbouring carbonyl group. The remaining protons of the deoxyribose appear between 3.6-4.33 ppm, except for H2' at 2.1 ppm (see Table 3.2.5.A).

Two carbonyl singlet carbons at 164.0 and 150.8 ppm in the ^{13}C -NMR spectrum appeared (see Figure 3.2.5.C). In addition, one more singlet carbon was also observed at 109.7 ppm (carbon carrying the methyl group). The DEPT spectrum (see Figure 3.2.5.D) showed one quartet signal of the methyl group at 12.5 ppm and two triplets of the two methylene groups in the deoxyribose at 39.7 and 61.7 ppm (see Table 3.2.5.A).

The position and the arrangement of the carbons of the deoxyribose sugar were confirmed through a COSY spectrum (see Figure 3.2.5.E, F) and (Table 3.2.5.A).

Results

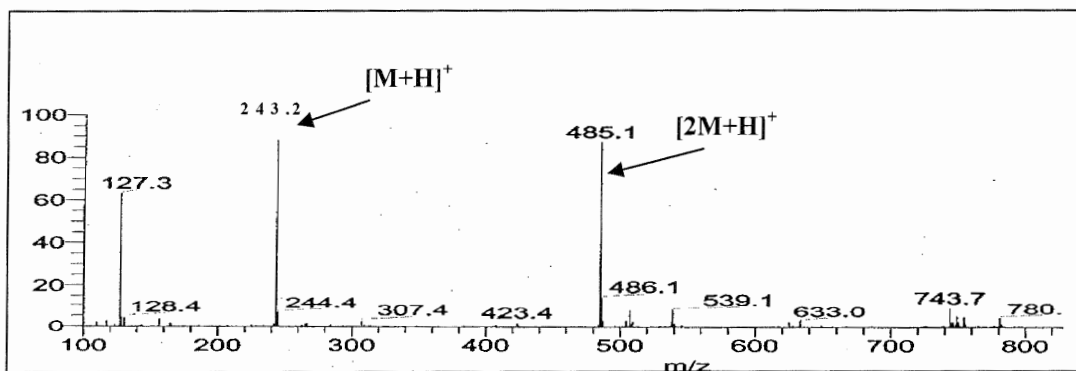

Fig.3.2.5.A: ESI⁺ mass spectrum of 2-deoxythymidine (compound 13)

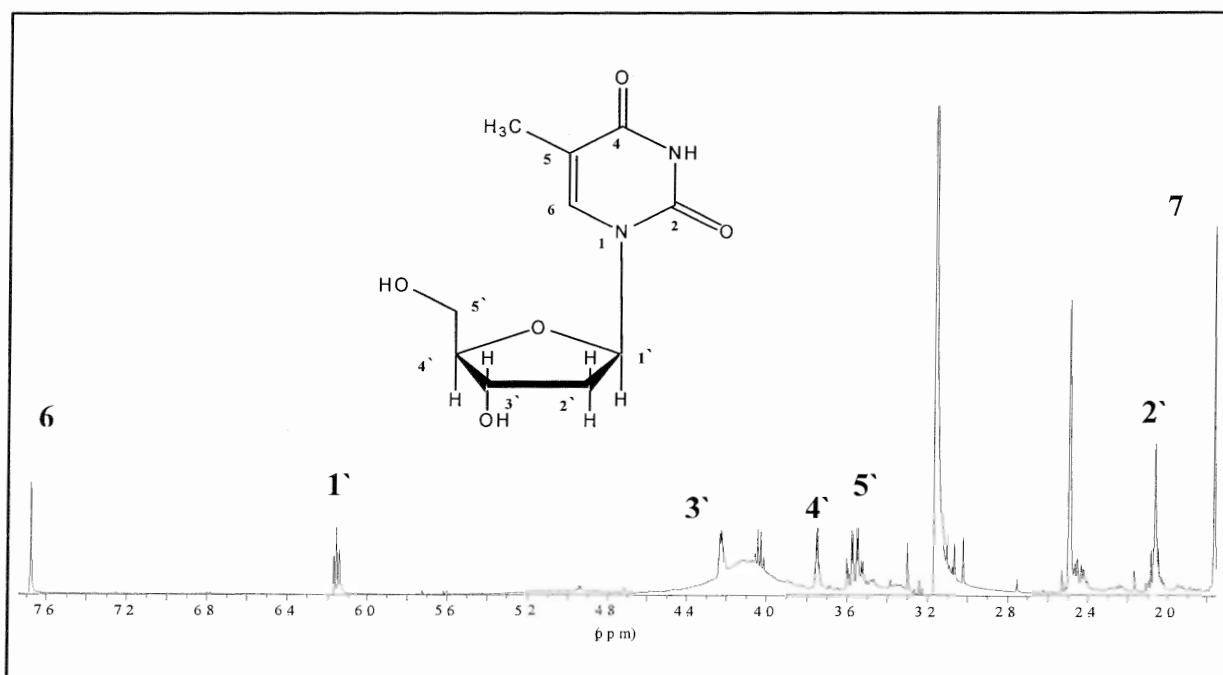

Figure: 3.2.5.B ¹H-NMR spectrum of 2-deoxythymidine (compound 13)

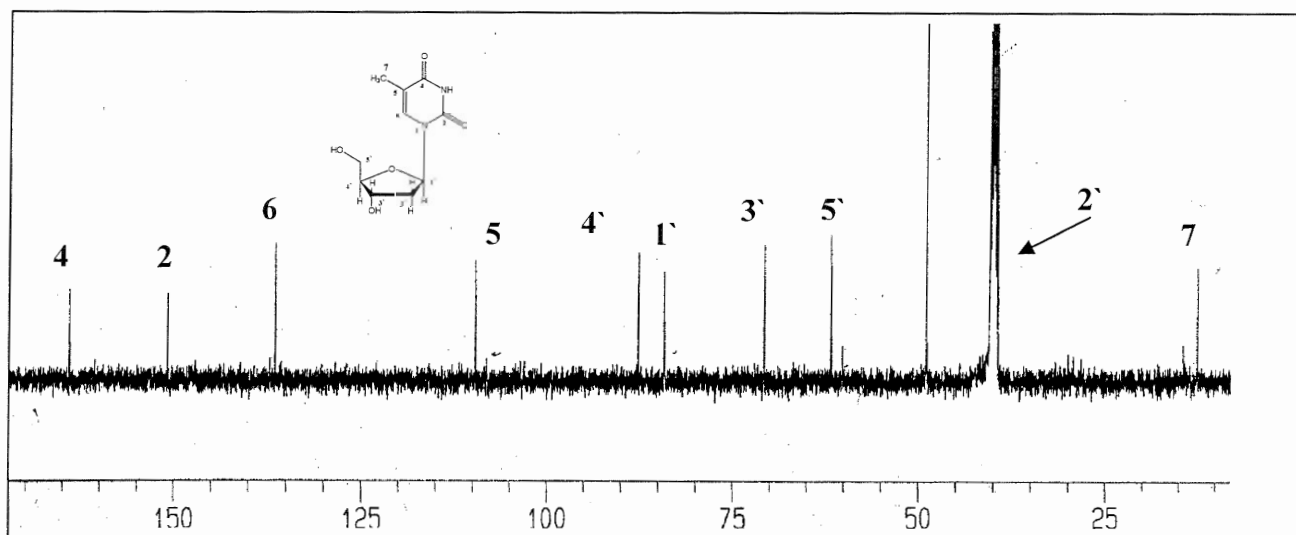

Figure 3.2.5.C: ¹³C-NMR spectrum of 2-deoxythymidine (compound 13)

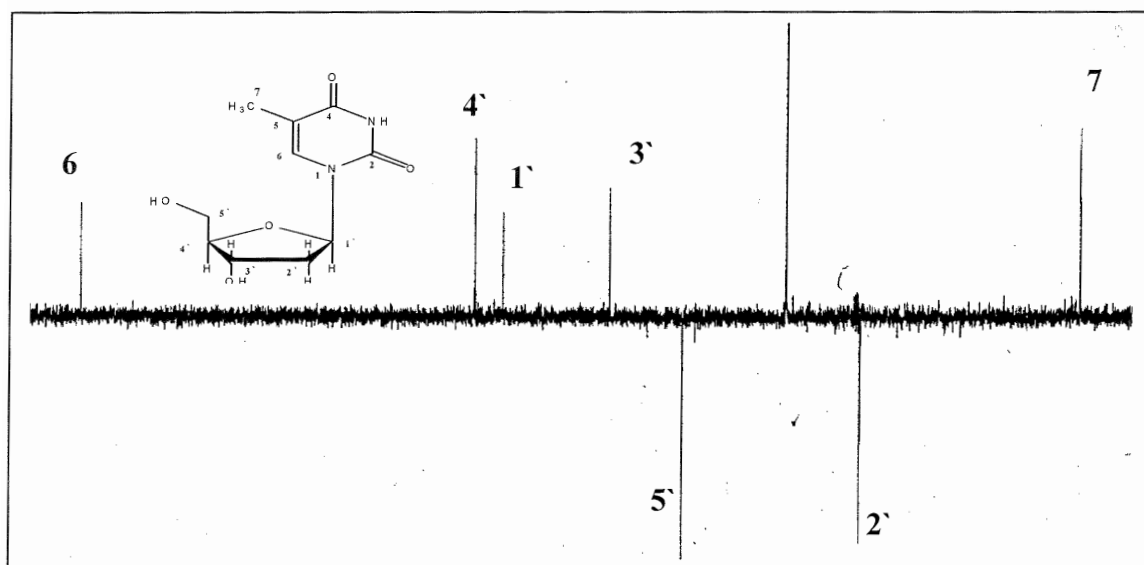

Figure 3.2.5.D: DEPT spectrum of 2-deoxythymidine (compound 13)

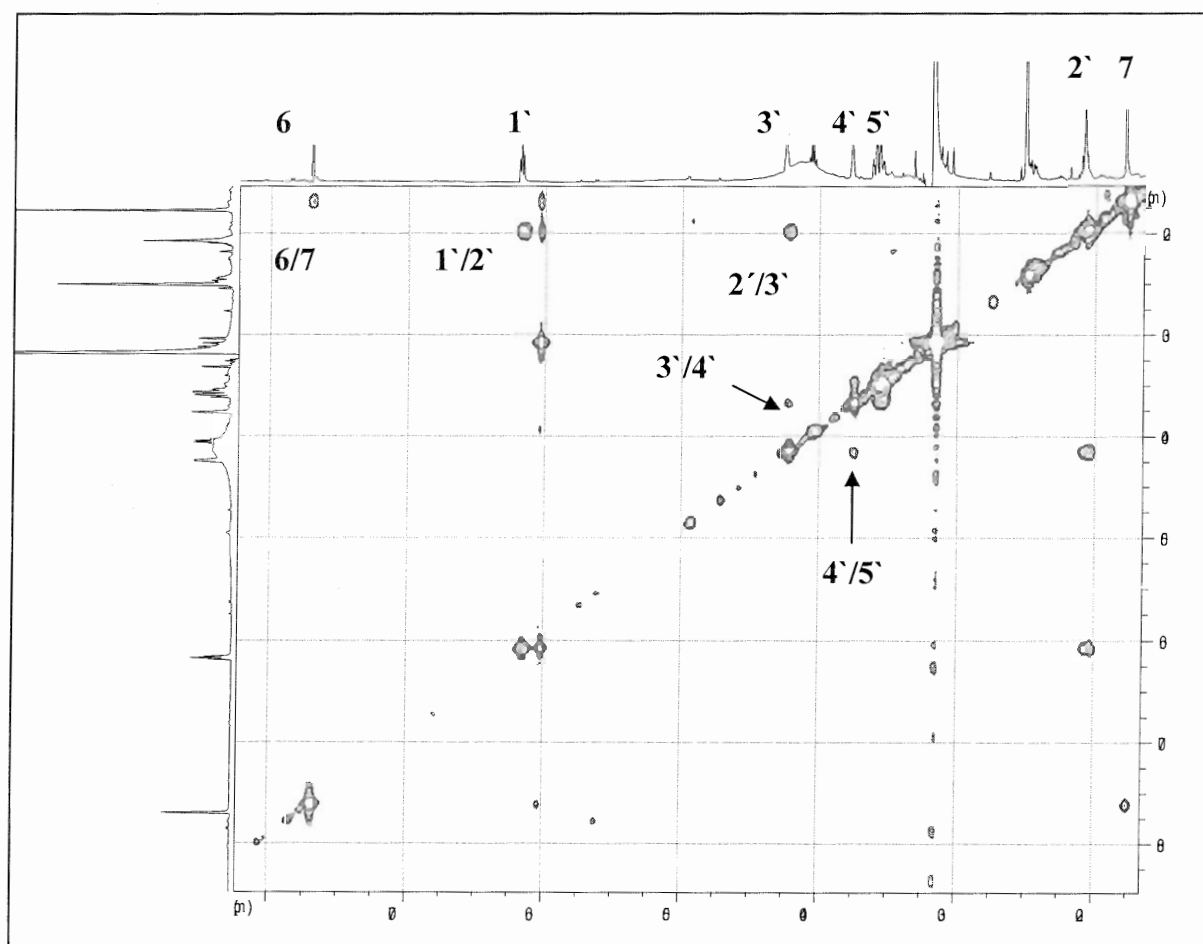

Figure 3.2.5.E: COSY spectrum of 2-deoxythymidine (compound 13)

Results

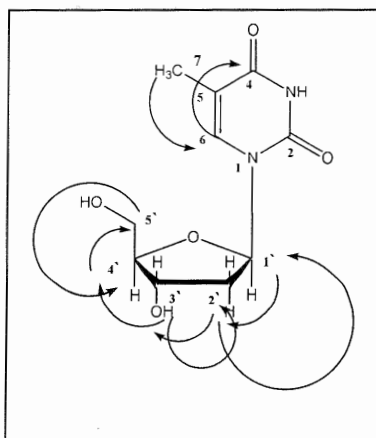

Figure 3.2.5.F: COSY correlations of 2-deoxythymidine (compound 13)

Table 3.2.3.A: NMR data of 2-deoxythymidine (compound 13)

No	13		
	¹ H NMR (ppm), multiplicity (Hz)	¹³ C-NMR (ppm)	COSY (H→H)
2	-	150.8 s	-
4	-	164.0 s	-
5	-	109.7 s	-
6	7.7 (1H, s)	136.4 d	7
7	1.75 (3H, s)	12.5 q	6
1'	6.15 (1H, dd, $J = 6.6, 2.2$ Hz)	84.2 d	2'
2'	2.15, br.s	39.5 t	3'
3'	4.25 (1H, dd, $J = 3.1, 5.9$ Hz)	70.8 d	4'
4'	3.76 (1H, dd, $J = 3.7, 6.9$ Hz)	87.6 d	5'
5'	3.55 (2H, dddd, $J_{5'a-4'} = 3.7,$ $J_{5'b-4'} = 11.6$ Hz)	61.7 d	4'

The compound was measured in MeOH-*d*₆.

3.3 Tryptophan derivatives from the sponge *Fascaplysinopsis reticulata*.

Nitrogen-containing metabolites were rarely reported from the sponge *Fascaplysinopsis reticulata*, family Thorectidae (Jimenez *et al.*, 1991). Luffariellolides are sesterterpenes that are known to have activity as anti HIV compounds. Isodehydroluffarielloide and dehydroluffarielloide diacid (see Figure 3.3) were isolated together with alkaloids as salts from the sponge *Fascaplysinopsis reticulata* collected from Fiji (Jimenez *et al.*, 1991).

In the present study on the sponge *Fascaplysinopsis reticulata*, that was collected from Indonesia, eight compounds were isolated, most of them being alkaloids of the group of hydantoin (=imidazolidine-2,4-dione) derivatives. Many of these metabolites were previously isolated as natural products and also synthesized in the laboratory (Jaske *et al.*, 2001). Natural origins for these compounds are the Jamaican sponge *Smenospongia aurea*, *Scleractnian* corals, the sponge *Verongia spengelii* and the anthozoan *Astroides calycularis* (Marine Lit., 2003). Most of the compounds isolated from *Fascaplysinopsis reticulata* belong to purine or tryptophan derived alkaloids.

These metabolites were previously reported to exhibit significant biological activity against filarial parasites (Singh *et al.*, 1997). They were also reported to have antidepressant activity, act as competitive inhibitors of monoamine oxidase and on the serotonin receptor, showing 5-HT₂ receptor and 5-HT_{2C}-selective activity (Neant *et al.*, 1988).

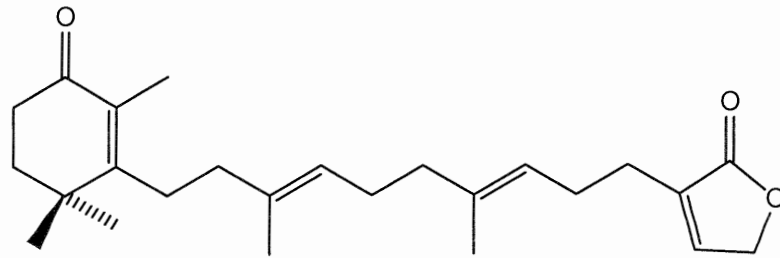

isodehydroluffarielloide

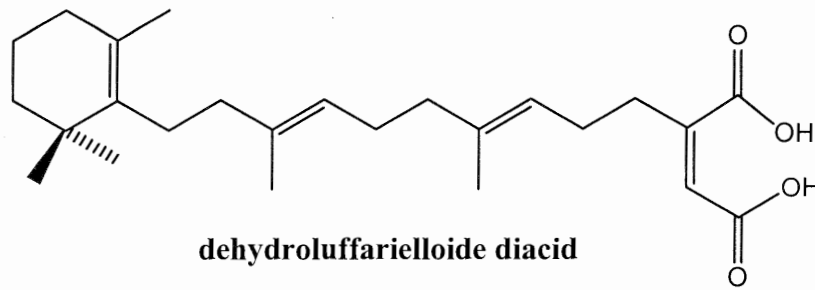

dehydroluffarielloide diacid

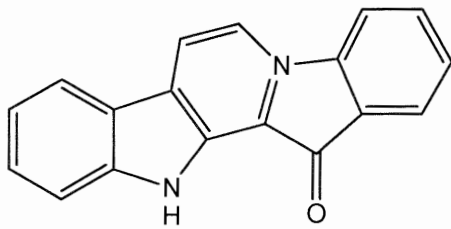

fascaplysin

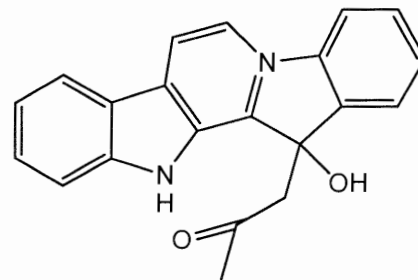

homofascaplysin A

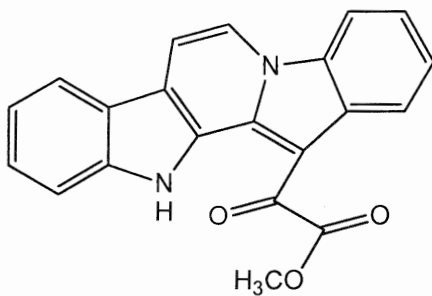

homofascaplysin B

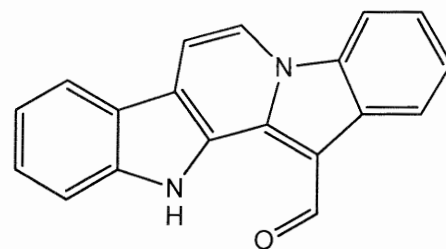

homofascaplysin C

Figure 3.3: Some compounds isolated from *Fascaplysinopsis reticulata*

Results

7-Methyl-6-methylamino-7, 9-dihydro-purin-8-one (compound 14)

Chemical name: 7-Methyl-6-methylamino-7, 9-dihydro-purin-8-one

Character: red-orange amorphous powder **Amount:** 10 mg

Sample code: TM27 eth.si.10

Molecular weight: 179 g / mol

Biological source: marine sponge *Fascaplysinopsis reticulata* (TM 27)

Molecular formula: C₇H₉N₅O

New natural product

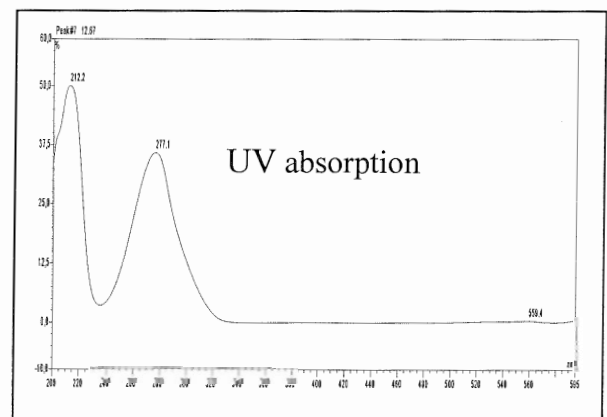
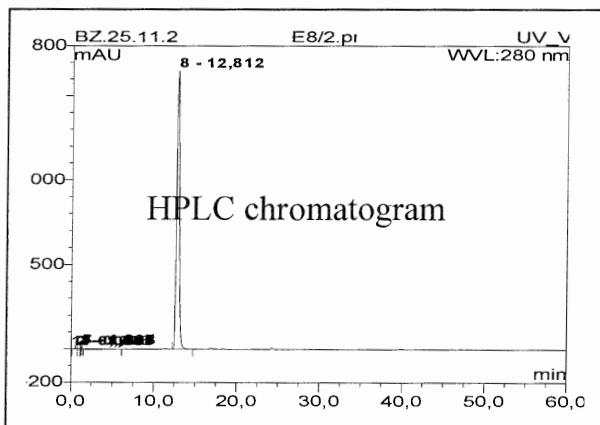
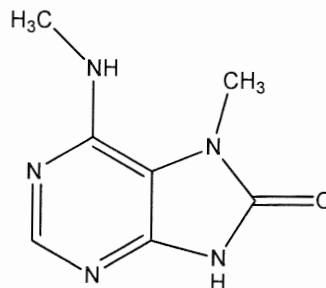

ESIMS: m/z 179 [M+H]⁺ (Positive)

HREIMS: $m/z = 179$ [M]⁺ Experimental = 179.08019
Calculated = 179.08070
for C₇H₉N₅O

3.3.1 Structure elucidation of 7-methyl-6-methylamino-7,9-dihydro-purin-8-one [14]

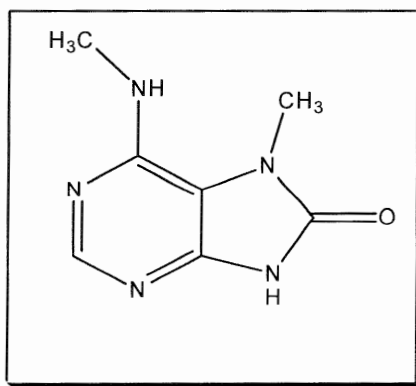

Compound 14 is a purine derivative. A number of compounds containing substituted purines have been isolated from sponges including purine nucleosides, guanine derivatives and adenine derivatives. Most of these metabolites have previously been isolated from the sponge *Agelas* and from the Antarctic sponge *Isodictya erinacea* (Moon *et al.*, 1998) as well as from the sponge *Amphimedon viridis* (Chehade *et al.*, 1997).

Compound **14** was isolated as a red-orange amorphous powder. It has UV absorbances at λ_{\max} 212 and 277 nm. The ESIMS spectrum showed the molecular ion peak at m/z 180.3 $[M+H]^+$ (see Figure 3.3.1.A). By HREIMS (see Figure 3.3.1.B) the molecular formula was determined to be $C_7H_9N_5O$.

The 1H -NMR spectrum (see Figure 3.3.1.C) showed one downfield singlet at 8.05 ppm (1H, s) of H-2 of the purine ring and one doublet at 6.51 ppm (1H, d) of the NH-10 coupling with the methyl group (C-11). In the aliphatic region, the signals of the two methyl groups appear down field at 3.59 and 2.92 ppm due to the attachment to a nitrogen atom. One methyl group appears more downfield than the other due to the effect of the neighbouring carbonyl group.

The ^{13}C -NMR (see Table 3.3.1.A) and HMQC spectrum show one carbonyl group at 152.5 ppm, the carbon attached to the proton of the purine ring at 150.4 ppm and the two methyl groups at 27.3 and 28.2 ppm, respectively.

The structure was confirmed by HMBC spectrum (see Figure 3.3.1.D). It showed a long correlation of the N-methyl group (CH_3 -11) with C-6 in the pyrimidine ring, confirming its attachment at NH-10 as well as the correlations of the other methyl group (CH_3 -12) with C-5 and C-8 which confirmed its attachment at NH-7 (see Table 3.3.1.A).

Results

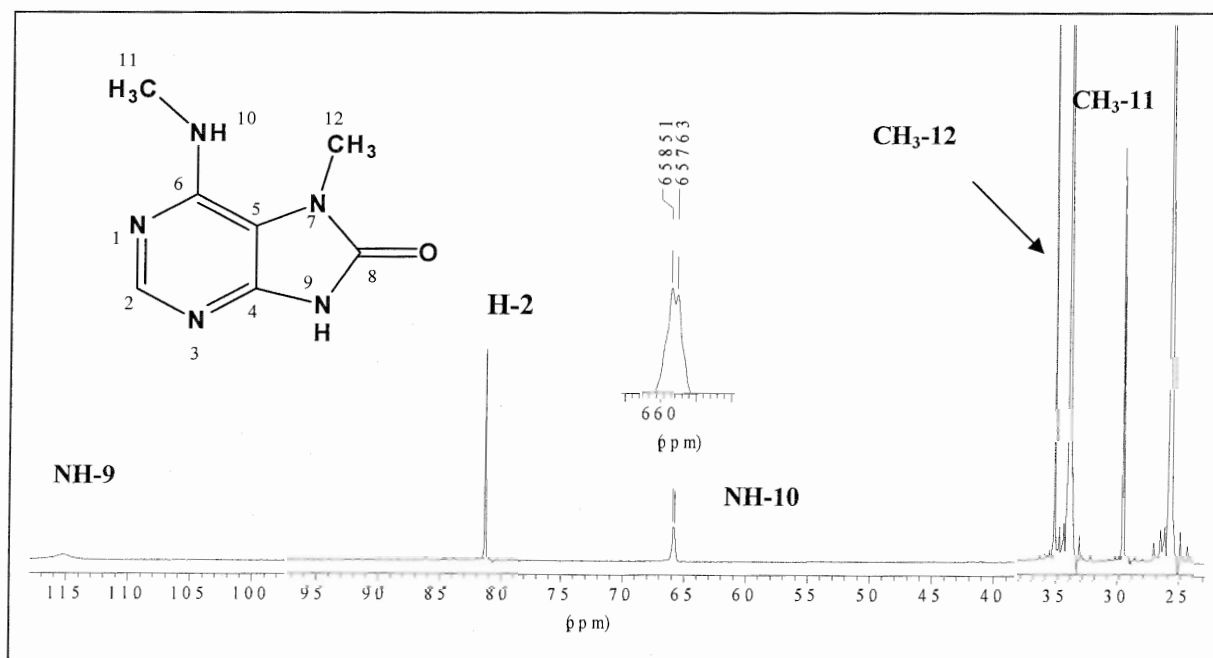
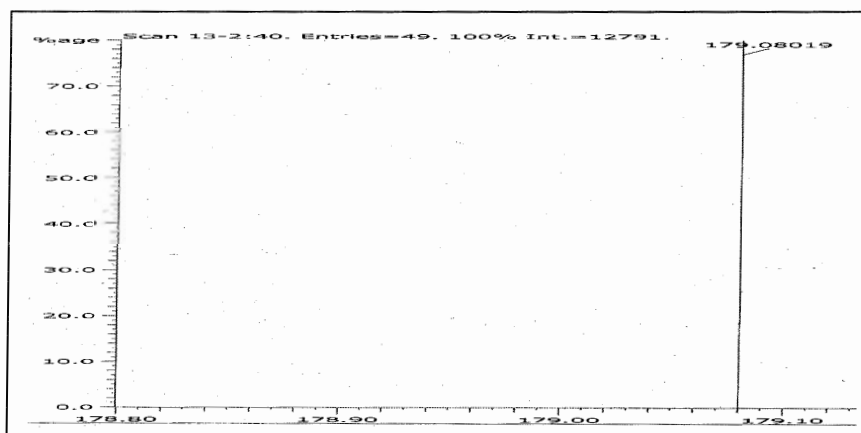
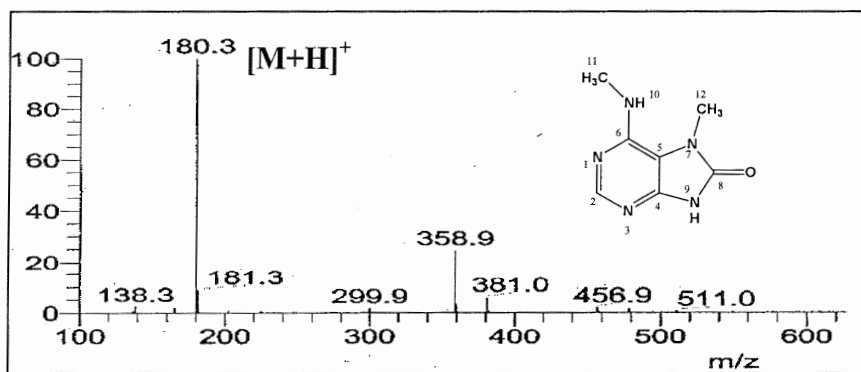

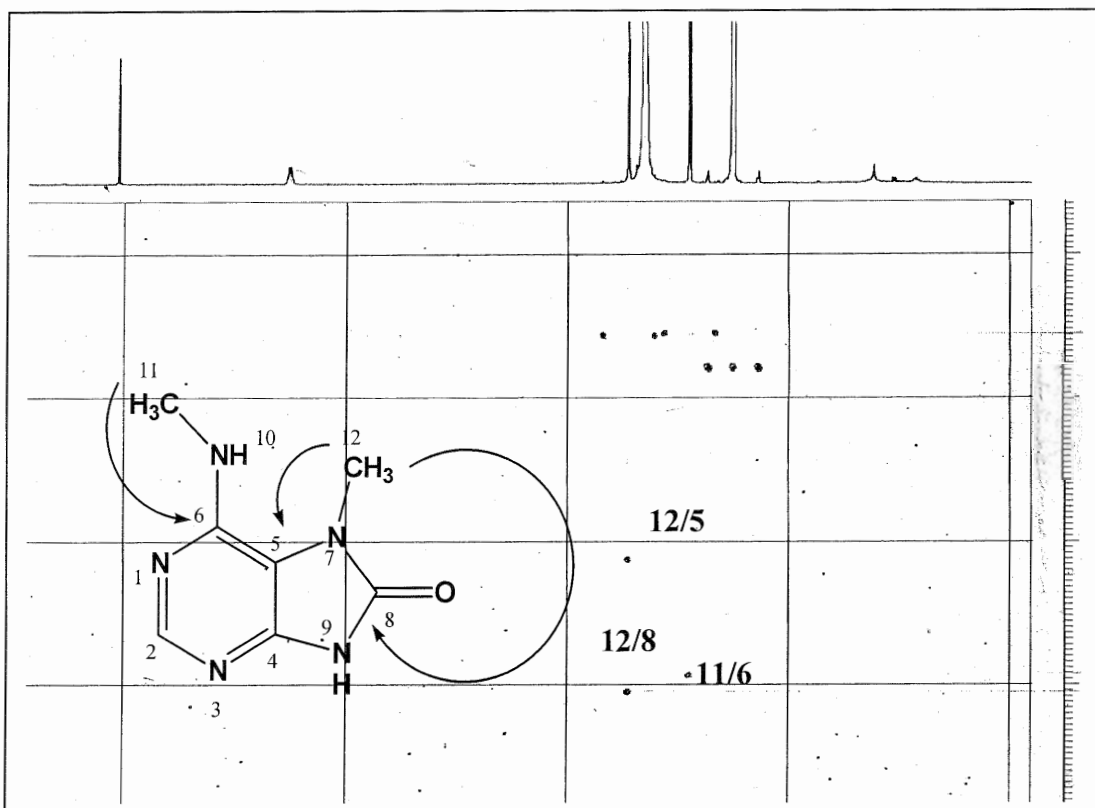

Figure 3.3.1.D: HMBC spectrum of compound 14

Table 3.3.1.A: NMR data of compound 14

No.	14		
	¹ H-NMR (ppm), multiplicity (Hz)	¹³ C-NMR (ppm)	HMBC
2	8.05 (1H, s)	150.5 d	-
4	-	-	-
5	-	106.1 s	-
6	-	146.7 s	-
8	-	152.5 s	-
NH-9	11.60 br.s	-	-
NH-10	6.51 (1H, d, <i>J</i> = 4.4 Hz)	-	-
CH3-11	2.92 (3H, d, <i>J</i> = 5.1 Hz)	27.3 q	6
CH3-12	3.59 (3H, s)	28.2 q	5,8

The compound was measured in DMSO-*d*₆.

6-Dimethylaminopurine (compound 15)

Chemical name: Dimethyl-(9H-purin-6-yl)-amine.

Character: yellow needles

Amount: 4 mg

Sample code: TM27 eth 8/2-prep3

Molecular weight: 163 g / mol

Biological source: marine sponge *Fascaplysinopsis reticulata* (TM-27)

Molecular formula: C₇H₉N₅

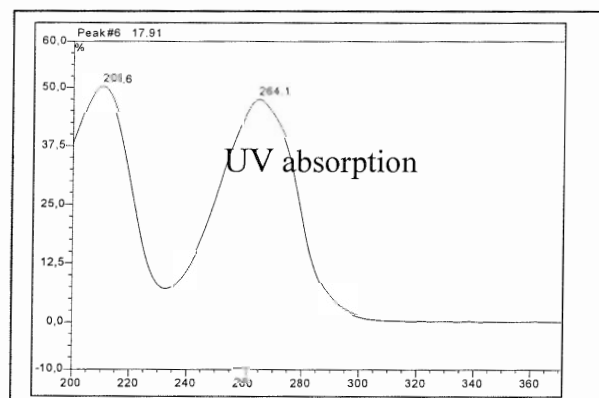
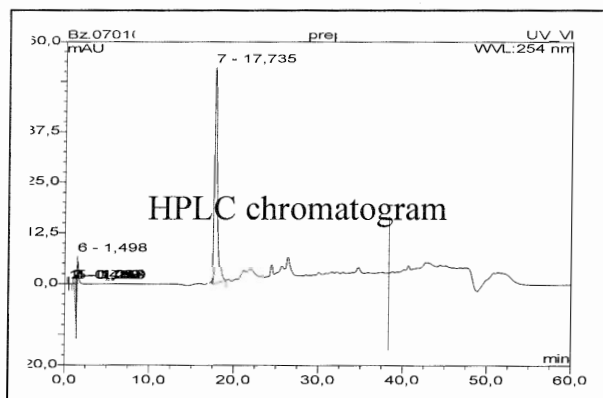
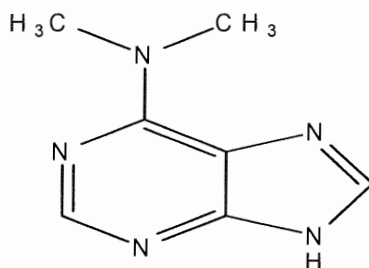

ESIMS: m/z 164 [M+H]⁺ (Positive)

3.3.2 Structure elucidation of 6-dimethylaminopurine [15]

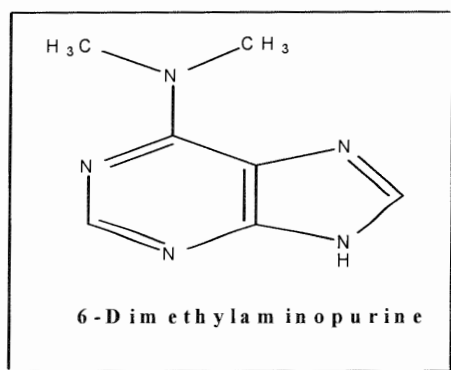

Compound 15 is a purine derivative and it is known under the abbreviation (6-DMAP). It is also known as one of the first substances acting as a CDK inhibitor. It was originally designed as a puromycin analogue, an inhibitor of protein biosynthesis, but it turned out that purine (6-DMAP) inhibits the mitosis of sea urchin oocytes without blocking protein biosynthesis, therefore, another mechanism of action had to exist and finally CDK1 ($IC_{50} = 120 \mu M$) was identified as the actual target (Huwe *et al.*, 2003).

Compound **15** showed a UV spectrum that is very similar to the previous purine derivative (compound **14**); it was isolated as yellow needles. It has UV absorbances at λ_{max} 209 and 264 nm. The ESIMS spectrum showed the molecular ion peak at m/z 164.3 $[M+H]^+$ (see Figure 3.3.2.A). This together with the NMR spectra suggested the molecular formula $C_7H_9N_5$. The 1H -NMR spectrum (see Figure 3.3.2.B) showed only three signals; two in the aromatic region at 8.08 ppm (1H, s) and 8.29 ppm (1H, s) and the third singlet standing for the two N-Methyl groups in the aliphatic region at 3.7 ppm (6H, s) (see Table 3.3.2.A).

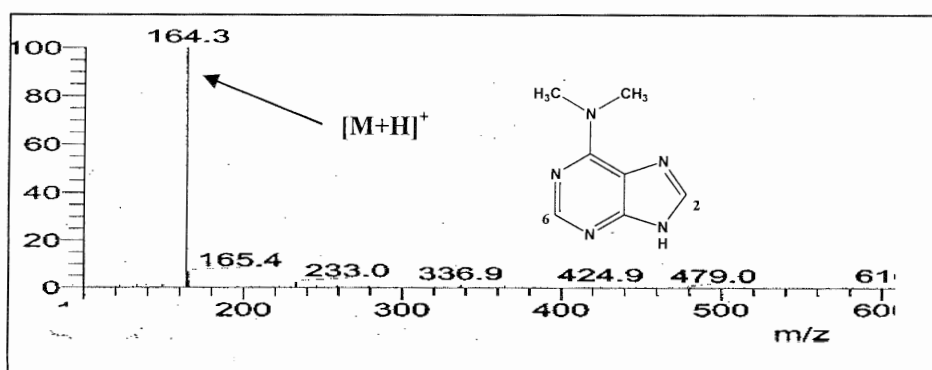

Figure 3.3.2.A: ESI^+ mass spectrum of 6-dimethylaminopurine (compound 15)

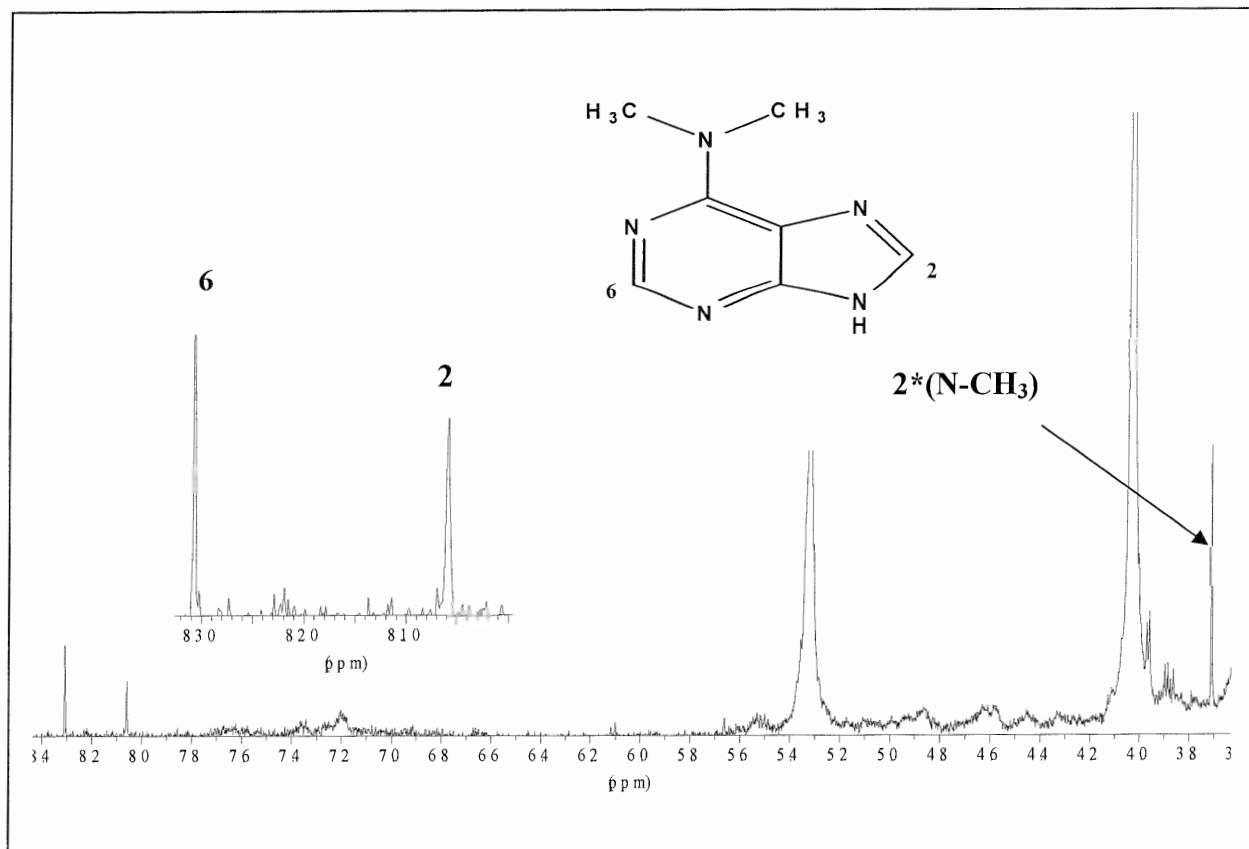

Figure 3.3.2.B: ¹H-NMR spectrum of 6-dimethylaminopurine (compound 15)

Table 3.3.2.A: ¹H NMR data of 6-dimethylaminopurine (compound 15)

H-No.	¹ H NMR (ppm), multiplicity (Hz)
H-1	-
H-2	8.08 (1H, s)
H-3	-
H-4	-
H-5	-
H-6	8.29 (1H, s)
H-7	-
N-CH ₃	3.70 (6H, s)

compound was measured in CD₃OD

The

2-(6-Bromo-1-methyl-1H-indol-3-yl)-acetamide (compound 16)

Chemical name: 2-(6-bromo-1-methyl-1H-indol-3-yl)-acetamide

Character: yellow-orange amorphous powder **Amount:** 3 mg

Sample code: TM27 E8/2.pr3

Molecular weight: 266/268 g / mol

Biological source: marine sponge *Fascaplysinopsis reticulata* (TM 27)

Molecular formula: C₁₁H₁₁BrN₂O

New natural product

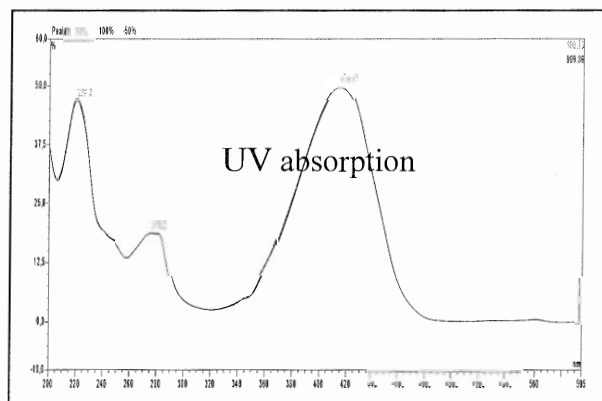
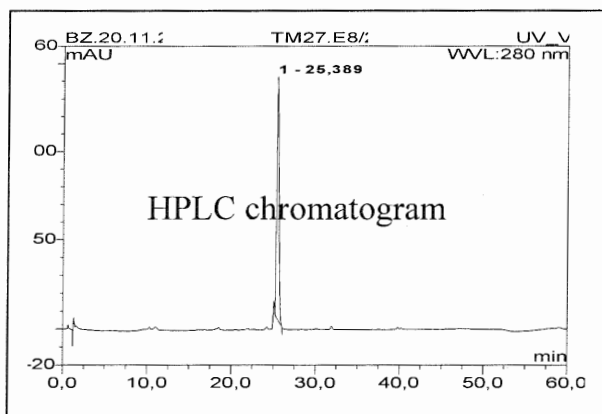
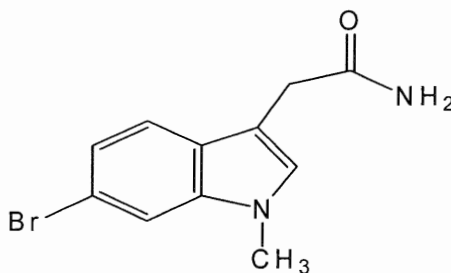

ESIMS: m/z 266/268 [M-H]⁻ (Negative)

3.3.3 Structure elucidation of 2-(6-bromo-1-methyl-1H-indol-3-yl)-acetamide [16]

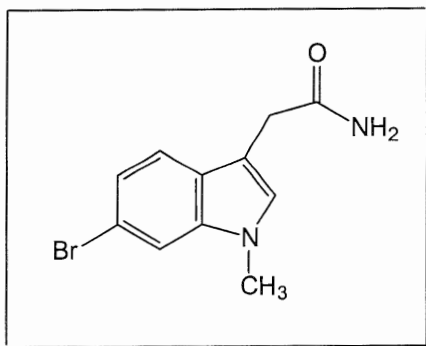

Compound 16 is a tryptophan derivative and was isolated as a yellow-orange amorphous powder. It has UV absorbances at λ_{max} 220, 278 and 414 nm. The EIMS spectrum showed two peaks at m/z 266/268 $[\text{M}-\text{H}]^-$ in a ratio of 1:1 which indicated the compound to be a monobrominated natural product (see Figure 3.3.3.A). This together with the NMR spectra suggested the molecular formula $\text{C}_{11}\text{H}_{11}\text{BrN}_2\text{O}$.

The ^1H -NMR spectrum (see Fig. 3.3.3.B) showed the typical coupling pattern of the phenyl ring system with a *meta* coupling proton H-7 at 7.74 ppm (1H, d), an *ortho* coupling proton H-4 at 7.98 ppm (1H, d) and an *ortho-meta* coupling proton H-5 at 7.40 ppm (1H, dd) (see Table 3.3.3.A). Furthermore, it showed a downfield singlet, at 8.15 ppm (1H, s), characteristic of the indole ring proton and the signal of a methyl group, which due to its location at the nitrogen atom appeared at 3.50 ppm (3H, s)

One carbonyl singlet carbon at 162.4 ppm in the ^{13}C -NMR spectrum was observed (see Table 3.3.3.A). In addition, one triplet carbon at 66.3 ppm, representing the methylene group in the side chain, and the signal of the methyl group at 29.3 ppm were observed.

The structure was confirmed by HMBC spectrum (see Figure 3.3.3.D); it showed a long correlation of H-2 in the indole ring with C-8 in the side chain, the correlation of the methylene group with the carbonyl group C-9 as well as the correlation of proton H-7 with C-5 (see Table 3.3.3.A). From the biosynthetic pathway of the brominated indole derivatives of this genus, the bromine atom should be at position C-6, which is identical with the later mentioned brominated indole derivatives (look compounds **19** and **20**).

Results

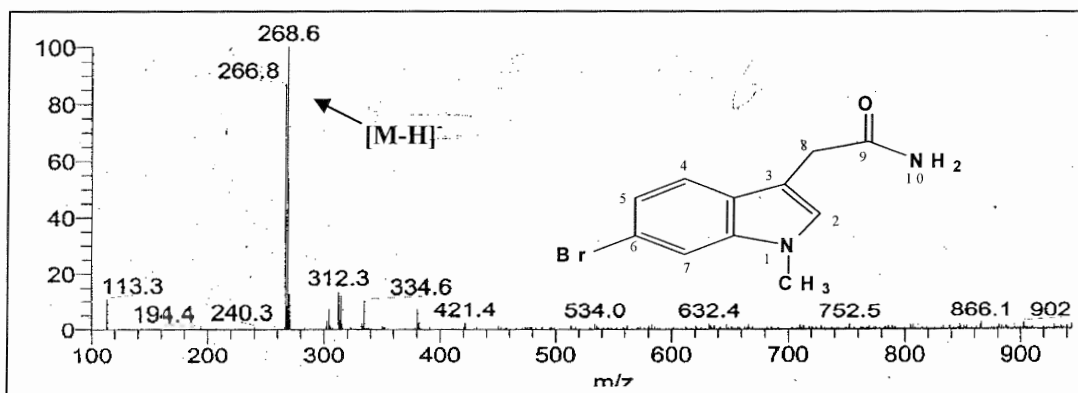

Figure 3.3.3.A: ESI mass spectrum of compound 16

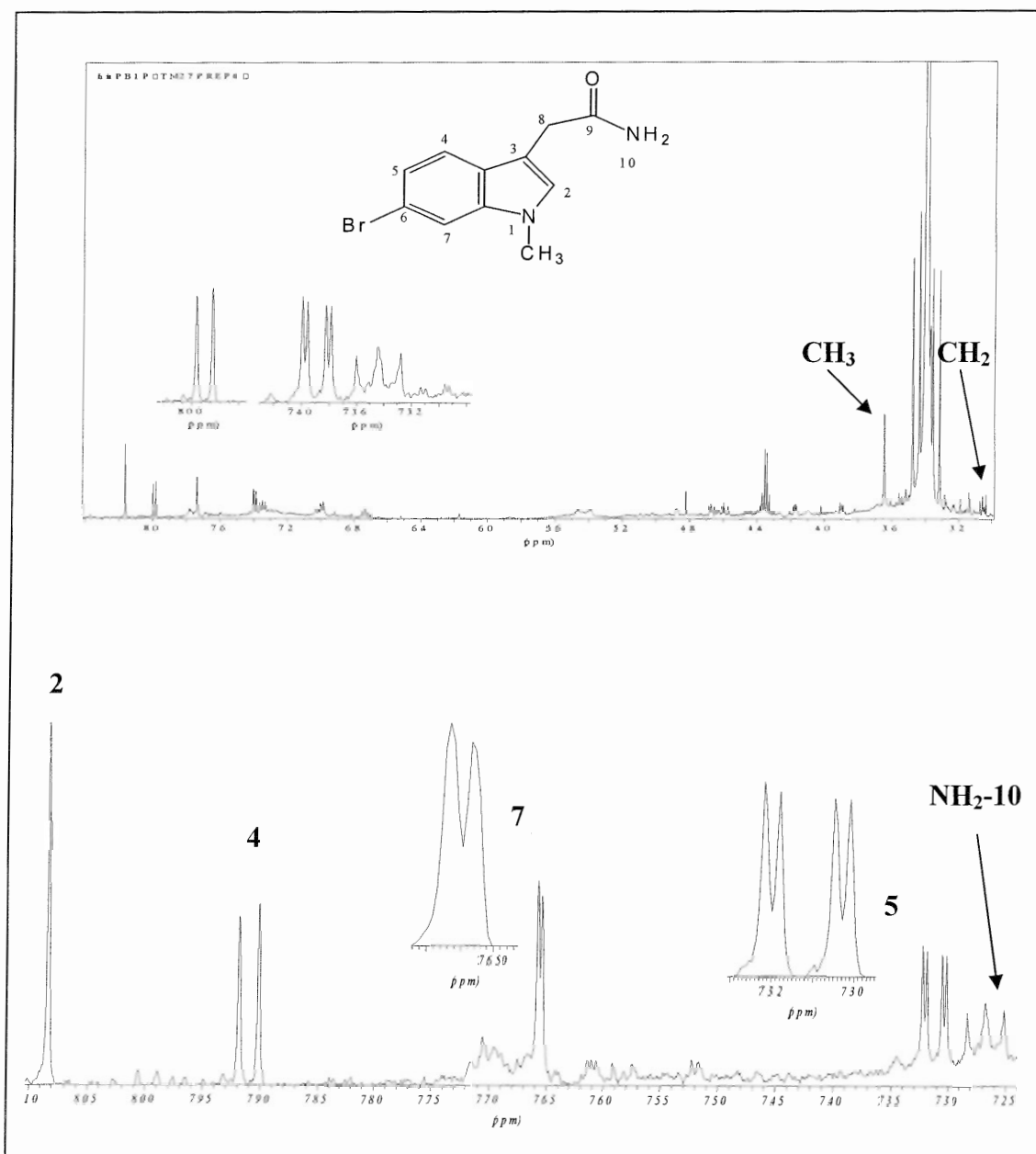

Figure 3.3.3.B: $^1\text{H-NMR}$ spectrum of compound 16

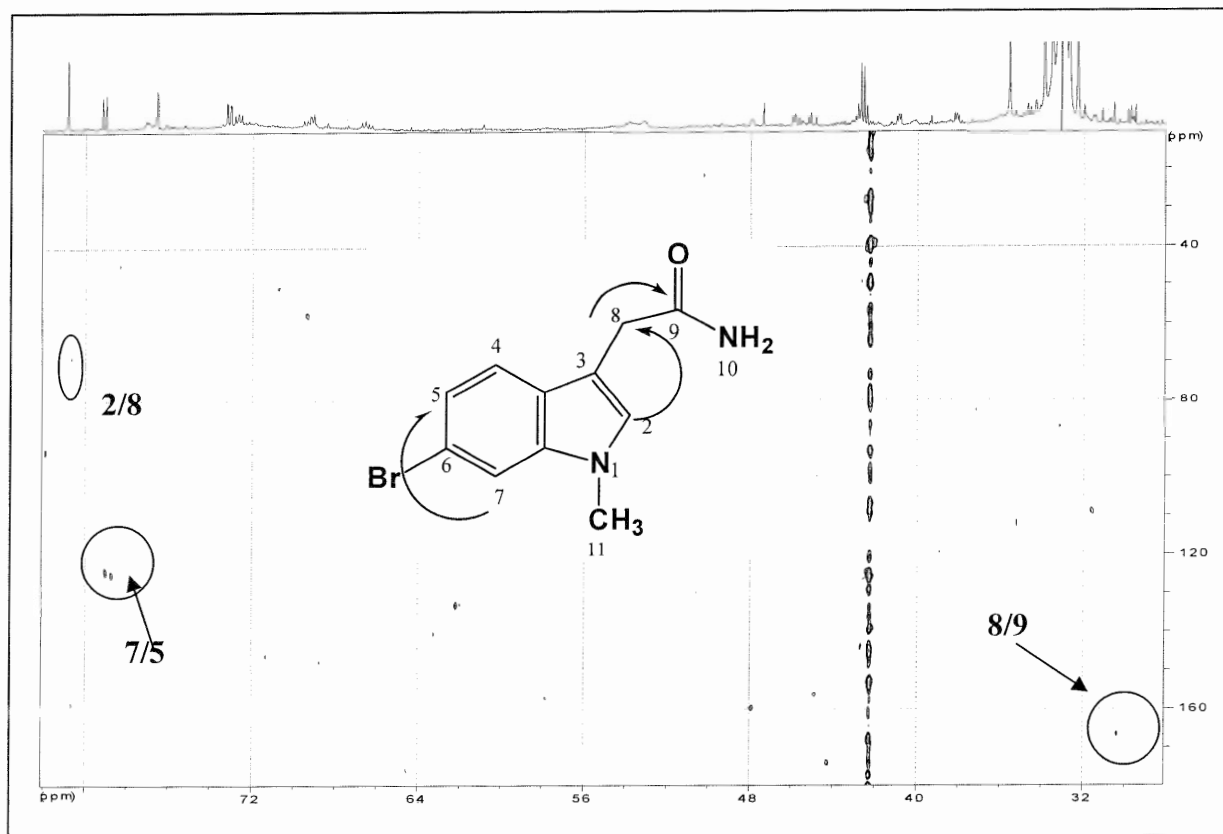
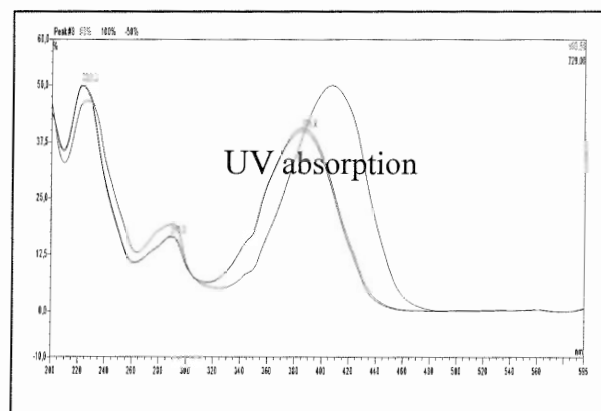
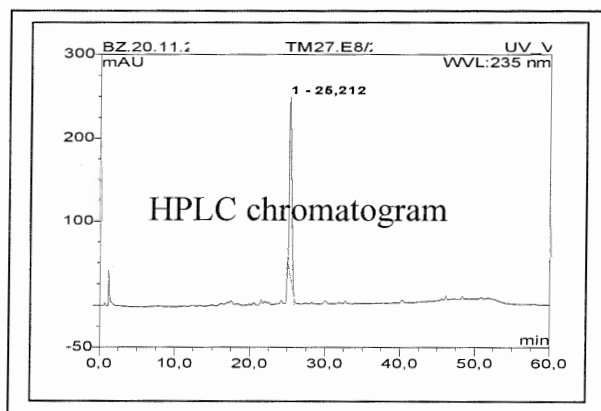
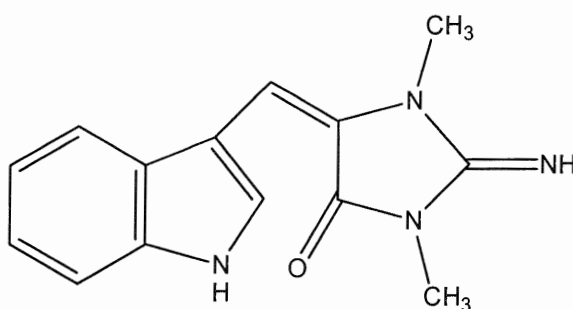

Figure 3.3.3.D: HMBC spectrum of compound 16

Table 3.3.3.A: NMR data of compound 16

No.	16		
	^1H NMR (ppm), multiplicity (Hz)	^{13}C -NMR (ppm)	HMBC H \rightarrow C
CH ₃	3.50 (3H, s)	29.3 q	-
2	8.15 (1H, s)	130.5 d	8
4	7.98 (1H, d, $J = 8.8$ Hz)	-	4a
5	7.4 (1H, dd, $J = 8.5, 1.5$ Hz)	122.4 d	-
7	7.74 (1H, d, $J = 1.5$ Hz)	-	5
8	2.95 (2H, s)	66.3 t	9
9	-	162.3 s	-
NH ₂ -10	7.35 (2H, t, $J = 8.2, 7.8$ Hz)	-	-

The compound was measured in DMSO- d_6 .

E/Z-aplysinopsin (compound 17-18)**Chemical name:** 2-Imino-5-(1H-indol-3-yl methylene)-1,3-dimethyl-imidazolidin-4-one**Character:** yellow needles**Amount:** 24 mg**Sample code:** TM27 E8/214, sephx.6 and sephx.4**Molecular weight:** 254 g / mol**Biological source:** marine sponge *Fascaplysinopsis reticulata* (TM 27)**Molecular formula:** C₁₄H₁₄N₄O**ESIMS:** m/z 255 [M+H]⁺ (Positive)

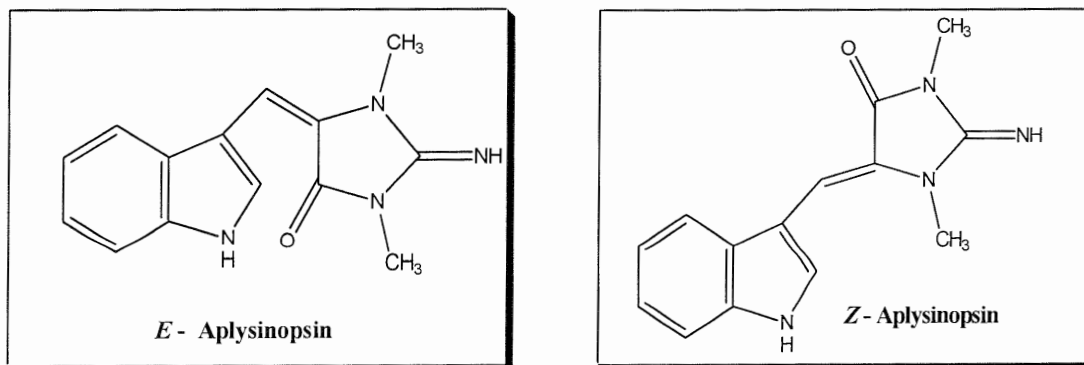
3.3.4 Structure elucidation of *E/Z*-aplysinopsin [17-18]

Aplysinopsin is a yellow tryptophan derivative that was previously isolated from the marine sponges *Thorecta sp.*, *Verongia spengelii*, *Aplysinopsis reticulata* and *Dercitus sp.* It was also reported as a metabolite in the Mediterranean anthozoan *Astroides calycularis* (Marine Lit., 2000).

***E*-aplysinopsin** was isolated as yellow needles. It has UV absorbances at λ_{\max} 219, 280 and 397 nm. The ESIMS spectrum showed the molecular ion peak at m/z 255.4 $[M+H]^+$ (see Fig. 3.3.4.A). This together with the NMR spectra suggested the molecular formula $C_{14}H_{14}N_4O$.

The 1H -NMR spectrum (see Fig.3.3.4.B) showed the characteristic coupling of the phenyl ring system in the aromatic region, multiplet signal H-5 and H-6 at 7.22 ppm (2H, m), two *ortho*- coupling protons H-4 at 7.84 ppm (1H, d) and H-7 at 7.45 ppm (1H, m), the characteristic olefinic proton at 6.88 ppm (1H, s), the downfield proton of the indole ring at 8.90 ppm (1H, s) and the two N-CH₃ groups at 3.2 and 3.39 ppm (3H, s) (see Table 3.3.4.A). The presence of two methyl groups binding to nitrogen atoms was concluded from the quartet signals at 25.9 and 28.5 ppm in the ^{13}C -NMR spectrum (see Table 3.3.3.A). In addition, two carbonyls at 167.5 and 151.4 ppm and the carbon of the olefinic proton at 101.7 ppm were observed.

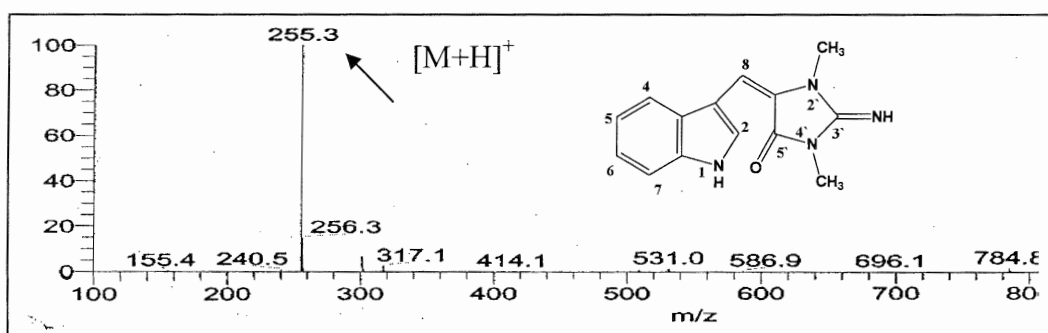

Figure 3.3.4.A: ESI⁺ Mass spectrum of compound 17-18

Figure 3.3.4.B: ^1H -NMR spectrum of compound 17

Table 3.3.4.A: NMR data of compound 17

No.	^1H -NMR (ppm), multiplicity (Hz)	^1H -NMR (ppm), multiplicity (Hz)*	^{13}C -NMR (ppm)
2	8.90 (1H, s)	8.72 (b.s)	129.6 d
4	7.84 (1H, d, $J=7.25$ Hz)	7.45 (b.d)	-
5	7.22 (1H, m)	7.15 (m)	122.7 d
6	7.22 (1H, m)	7.15 (m)	-
7	7.45 (1H, d, $J=6.93$ Hz)	7.89 (b.d)	-
8	6.88 (1H, s)	6.46 (b.s)	101.7 d
2'(CH ₃)	3.20 (3H, s)	3.07	25.9 q
3'	-	-	167.5 s
4'(CH ₃)	3.50 (3H, s)	3.26	28.5 q
5'	-	-	151.4 s

The compound was measured in CD_3OD .

* *E*-aplysinopsin measured (Fattorusso *et al.*, 1985) in $\text{DMSO}-d_6$

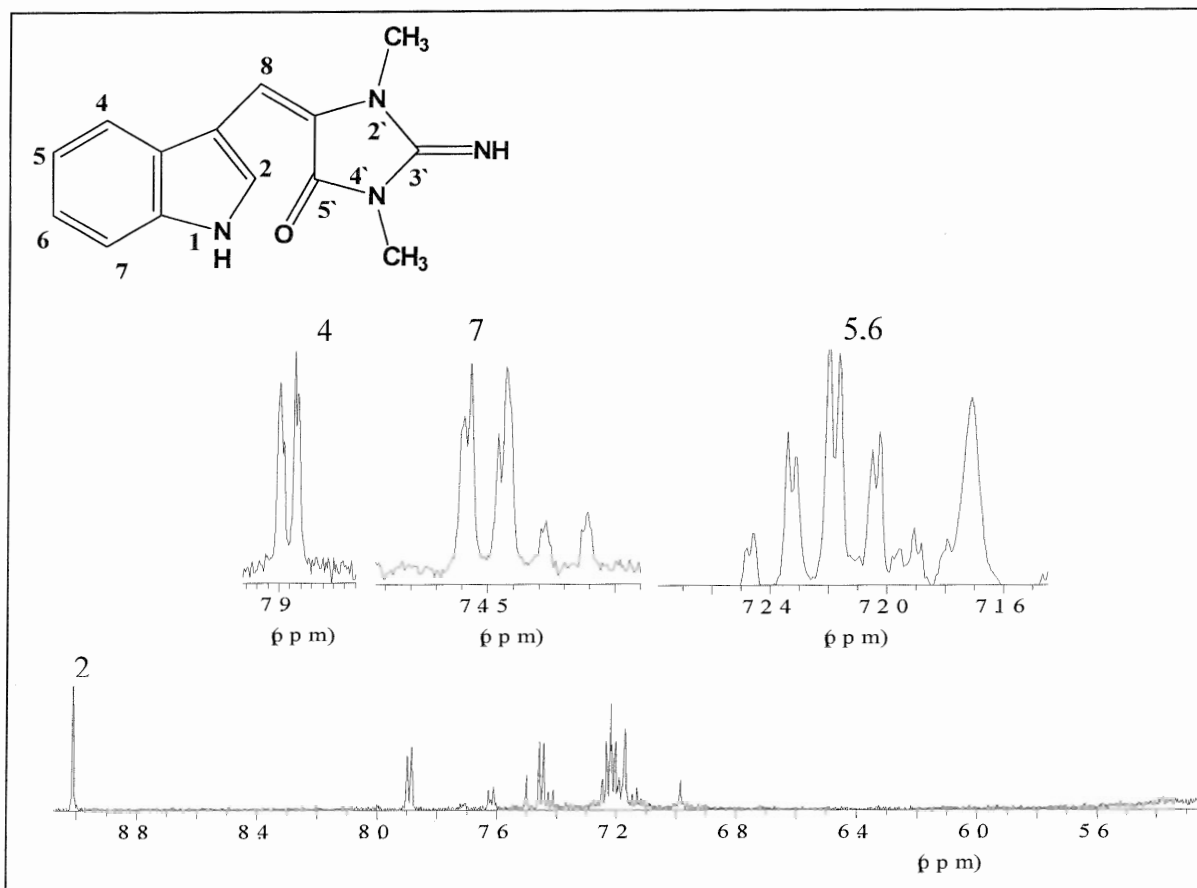
Results

Z-aplysinopsin was isolated together with *E*-aplysinopsin as yellow needles. It has UV absorbances at λ_{\max} 219.3, 280.2 and 414.8 nm. The ESIMS spectrum showed the molecular ion peak at m/z 255.4 $[M+H]^+$ (see Fig. 3.3.4.A).

The $^1\text{H-NMR}$ spectrum of *E/Z*-aplysinopsin mixtures (see Fig.3.3.4.C) showed four methyl groups (N-CH₃) at 3.15, 3.2, 3.25 and 3.51 ppm (3H, s). An important signal that differentiates the *E*-isomer from the *Z*-isomer is the olefinic proton H-2 which was observed at 7.80 ppm in *Z*-aplysinopsin and at 8.95 ppm in *E*-aplysinopsin, which is more downfield due to the direct influence of the carbonyl group. In the aromatic region the typical coupling of the indole ring system was found (see Table 3.3.4.C).

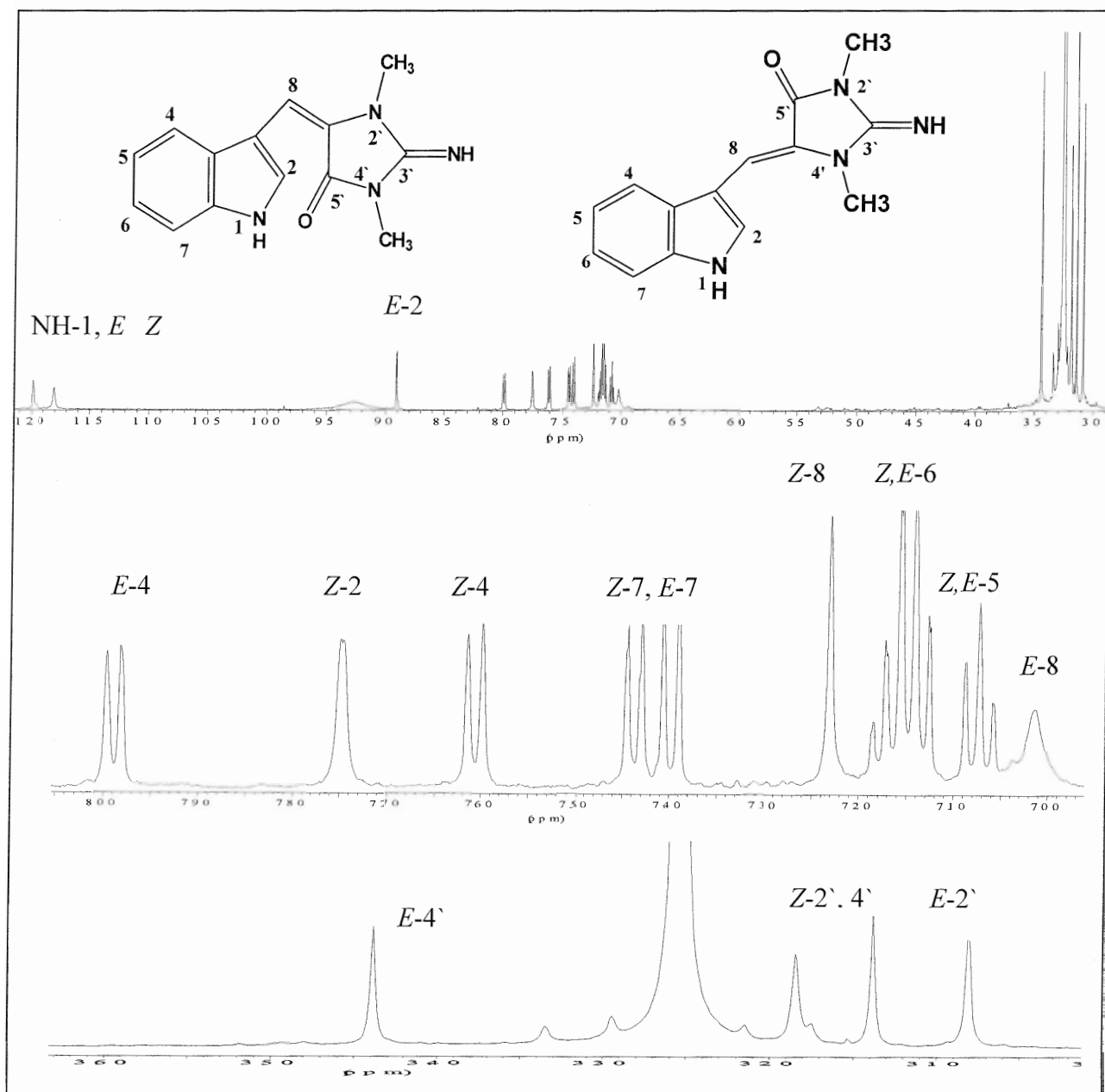

Figure 3.3.4.C: $^1\text{H-NMR}$ spectrum of *E/Z*-aplysinopsin

Results

The COSY spectrum (see Figure 3.3.4.D) showed the correlations of the *Z*-isomer as follows: the proton at 7.68 ppm with proton at 7.14 ppm (*Z*-4 to *Z*-5) and the proton at 7.20 ppm with proton at 7.50 ppm (*Z*-6 to *Z*-7). Furthermore, it showed the correlations of the *E*-isomer namely, the proton at 8.09 ppm with the proton at 7.14 ppm (*E*-4 to *E*-5) and also the proton at 8.09 ppm with the proton at 7.20 ppm (*E*-4 to *E*-6). Comparison of the NMR data of compound **17** and **18** with those reported (Guella *et al.*, 1988) showed that both spectra were very similar, which suggested that the two compounds were identical (see Table 3.3.4.B).

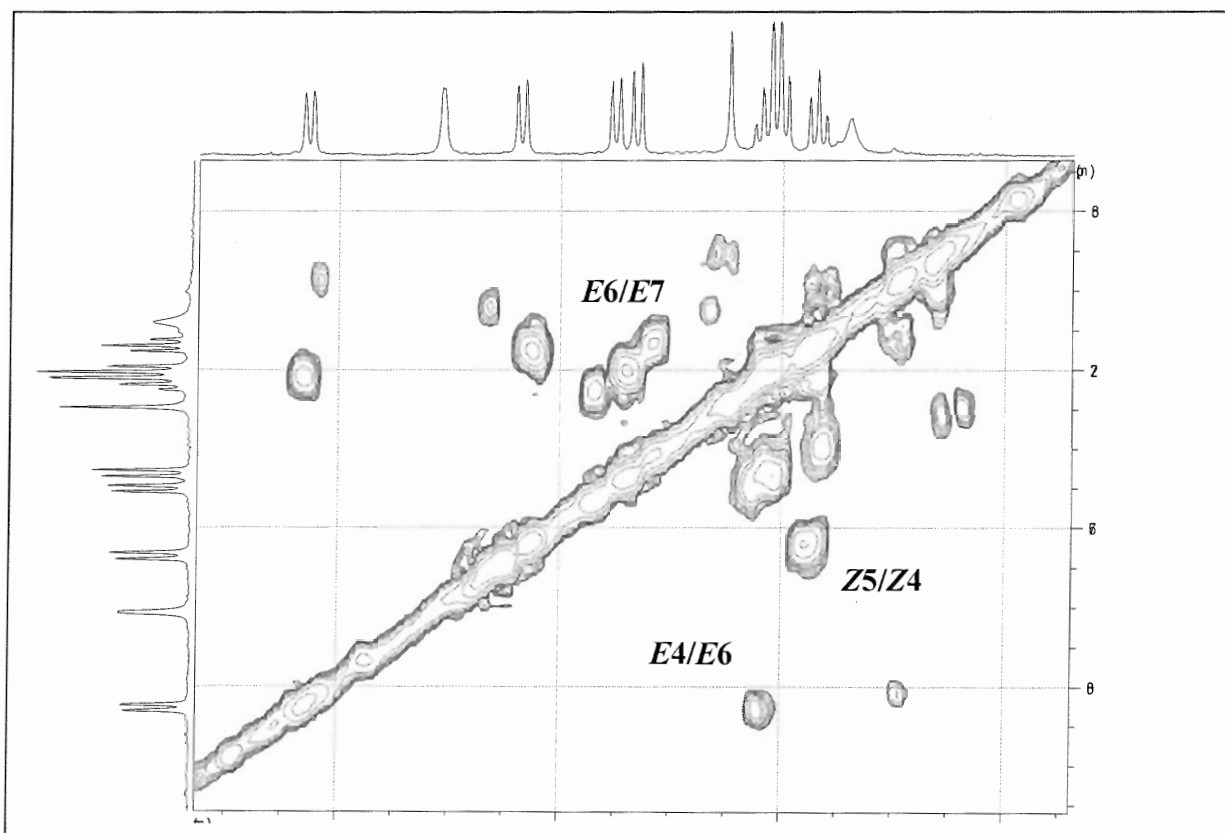

Figure 3.3.4.D: COSY spectrum of compounds 17 and 18

Table 3.3.4.B: ^1H -NMR data of compound 17 and 18

H-No.	^1H NMR (ppm), multiplicity (Hz) <i>E</i> -aplysinopsin (17)	^1H NMR (ppm), multiplicity (Hz) <i>Z</i> -aplysinopsin (18)
H-2	8.95 (d, $J = 3.15$ Hz)	7.8 (d, $J = 1.27$ Hz)
H-4	8.09 (d, $J = 6.94$ Hz)	7.68 (d, $J = 7.57$ Hz)
H-5	7.14 (t, $J = 6.93$ Hz)	7.14 (t, $J = 6.93$ Hz)
H-6	7.20 (t, $J = 7.56$ Hz)	7.20 (t, $J = 7.56$ Hz)
H-7	7.48 (d, $J = 7.56$ Hz)	7.50 (d, $J = 6.94$ Hz)
H-8	7.05 (1H, s)	7.29 (1H, s)
CH ₃ -2'	3.15 (3H, s)	3.25 (3H, s)
CH ₃ -4'	3.51 (3H, s)	3.22 (3H, s)
NH-1	12.07 (br.s)	11.87 (br.s)

The compounds were measured in DMSO- d_6 .

Table 3.3.6.C: ^1H -NMR data of *E/Z*-aplysinopsin measured in DMSO- d_6 (Guella *et al.*, 1988)

H-No.	^1H NMR (ppm), multiplicity (Hz) <i>E</i> -aplysinopsin (17)	^1H NMR (ppm) <i>Z</i> -aplysinopsin (18)
H-2	8.69 (d, $J = 2.4$ Hz)	7.57
H-4	7.87 (d, $J = 7.5$ Hz)	7.54
H-5	7.09 (t, $J = 7.05$ Hz)	7.09
H-6	7.15 (t, $J = 7.50$ Hz)	7.15
H-7	7.41 (d, $J = 7.50$ Hz)	7.40
H-8	6.43 (1H, s)	7.57
CH ₃ -2'	3.05 (3H, s)	3.04
CH ₃ -4'	3.25 (3H, s)	3.06
NH-1	11.50 (br.s)	11.50

6-Bromoaplysinsin (compound 19)

Chemical name: 5-(6-bromo-1H-indol-3-yl-methylene)-2-imino-1,3-dimethyl-imidazolidin-4-one

Character: yellow needles

Amount: 5 mg

Sample code: TM27 eth 8/2-pr2

Molecular weight: 333g / mol

Biological source: marine sponge *Fascaplysinsopsis reticulata* (TM-27)

Molecular formula: C₁₄H₁₃N₄OBr

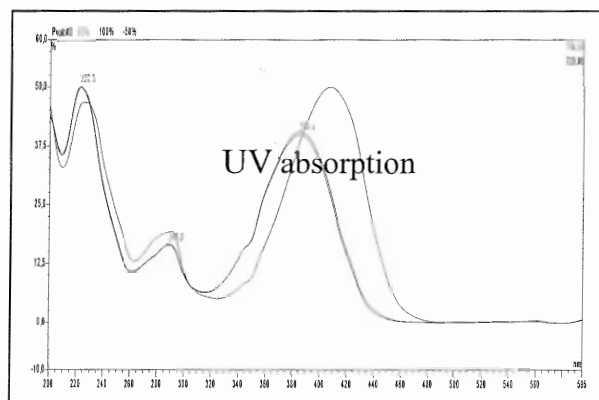
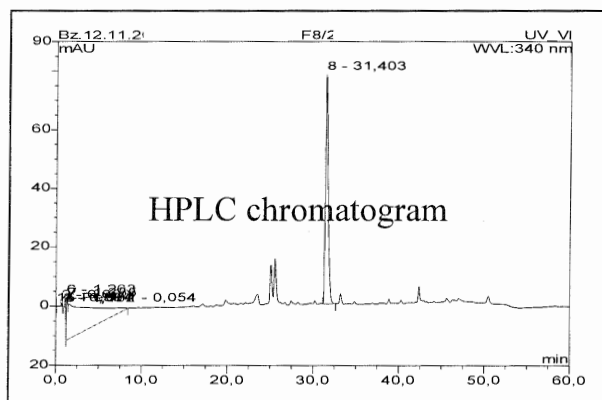
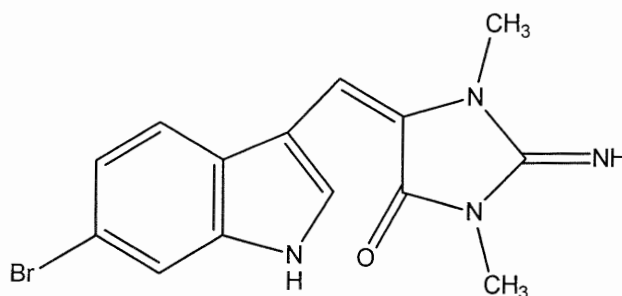

ESIMS: m/z 333/335 [M+H]⁺ (Positive)

3.3.5 Structure elucidation of 6-bromoaplysinopsin [19]

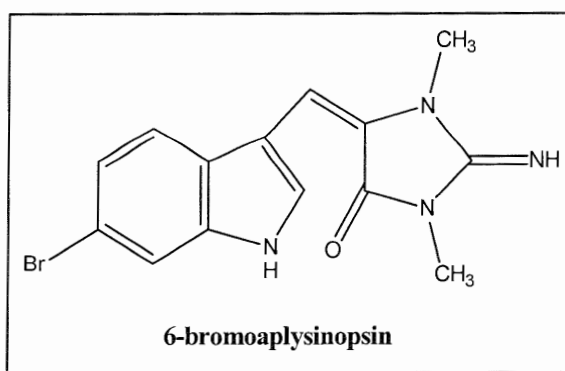

6-Bromoaplysinopsin was previously isolated from the sponge *Smenospongia aurea*, the anthozoan *Astroides calycularis* and the coral *Tubastrea coccinea* (Fattorusso *et al.*, 1985)

Compound [19] was isolated as yellow needles. It has UV absorbances at λ_{max} 234, 292 and 392 nm. The mass spectrum (see Figure 3.3.5.A) exhibited molecular ion peaks of equal intensities at m/z 333/335, hence the compound must contain one bromine atom. The molecular formula was suggested to be $\text{C}_{14}\text{H}_{13}\text{N}_4\text{OBr}$.

The UV spectrum was similar to that of aplysinopsin **17**; Moreover the ^1H -NMR spectrum (see Figure 3.3.5.B) was strongly reminiscent of that of compound **17**, showing a *meta* coupling proton H-7 at 7.70 ppm (1H, d), an *ortho* coupling proton H-4 at 8.04 ppm (1H, d) and an *ortho-meta* coupling proton H-5 at 7.35 ppm (1H, dd) (see Table 3.3.5.A). It also showed a doublet downfield at 8.85 ppm (1H, d) due to the proton in the indole ring and the two N- CH_3 groups at 3.49 and 3.15 ppm (3H, s).

One singlet of the carbonyl carbon downfield at 158.0 ppm was observed in the ^{13}C -NMR spectrum (see Table 3.3.5.A). In addition, it showed one doublet at 127.7 ppm and two quartets of the N- CH_3 at 23.8 and 26.9 ppm.

Comparison of the NMR data of compound **[19]** with those reported in the literature (Fattorusso. *et al.*, 1985) (see Table 3.3.6.B) showed that both spectra were very similar, suggesting that the two compounds are identical.

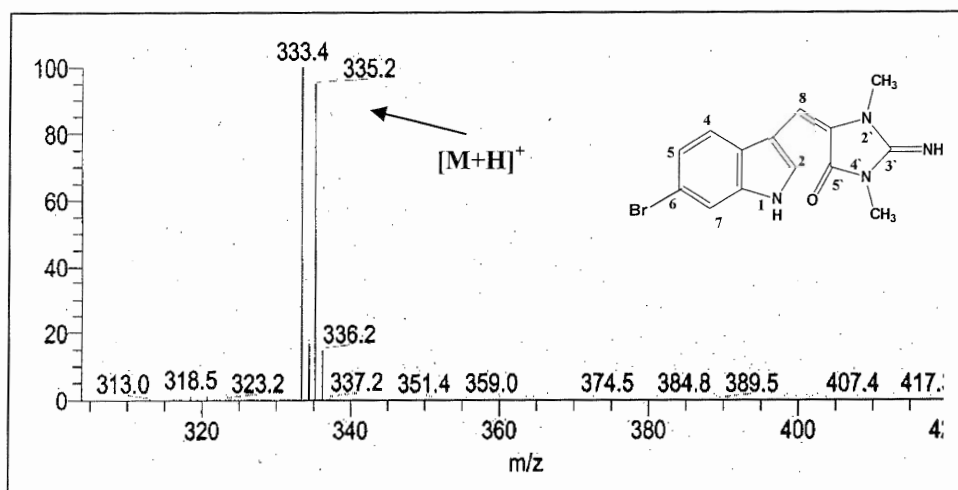

Figure 3.3.5.A: ESI⁺ mass spectrum of compound 19

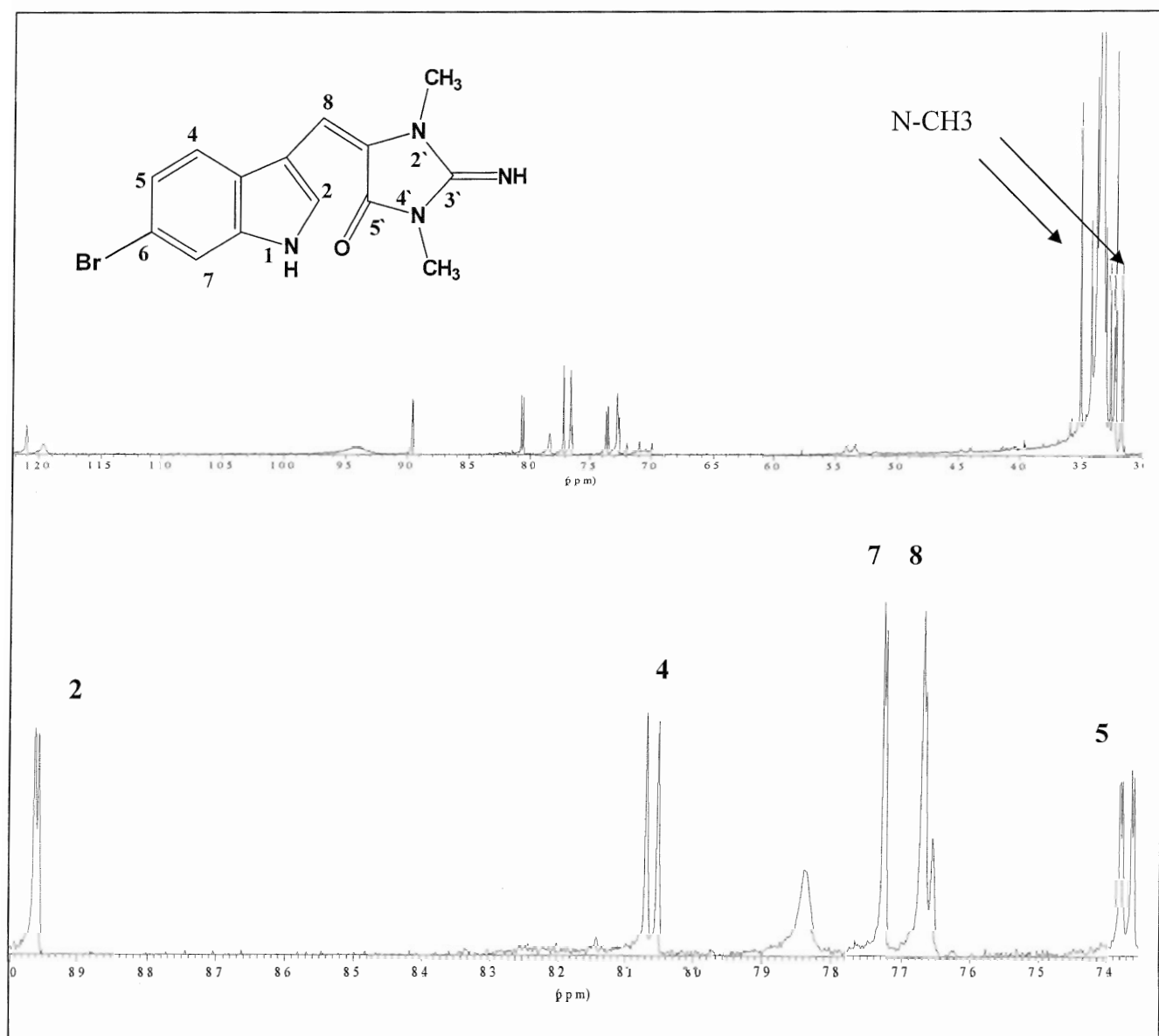

Figure 3.3.5.B: ¹H-NMR spectrum of compound 19

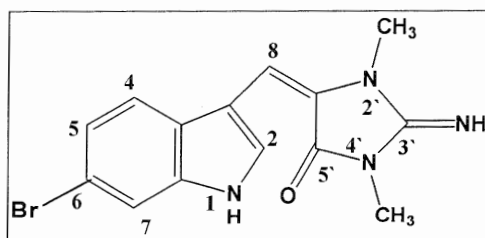

Table 3.3.5.A: NMR data of compound 19

No.	19	
	¹ H NMR (ppm), multiplicity (Hz)	¹³ C-NMR (ppm)
2	8.95 (1H, d, <i>J</i> = 6.5 Hz)	127.7 d
4	8.04 (1H, d, <i>J</i> = 8.8 Hz)	118.2 d
5	7.35 (1H, dd, <i>J</i> = 8.8, 1.8 Hz)	122.1 d
7	7.70 (1H, d, <i>J</i> = 1.8 Hz)	-
8	7.60 (1H, d)	100.4 d
2'(CH ₃)	3.15 (3H, s)	23.8 q
3'	-	158.0 s
4'(CH ₃)	3.50 (3H, s)	26.9 q
5'	-	153.3 s
NH-1	12.07 (br.s)	-

The compound was measured in DMSO-*d*₆.

6-Bromo-3'-deimino-3-oxoaplysinopsin (compound 20)

Chemical name: 5-(6-Bromo-1H-indol-3-ylmethylene)-1,3-dimethyl-imidazolidine-2,4-dione.

Character: yellow amorphous powder

Amount: 2 mg

Sample code: TM27 eth. si.5.p.5.3

Molecular weight: 334 g / mol

Biological source: marine sponge *Fascaplysinopsis reticulata* (TM-27)

Molecular formula: C₁₄H₁₂BrN₃O₂

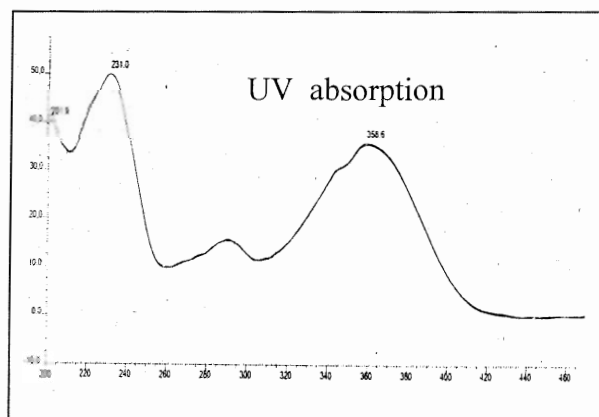
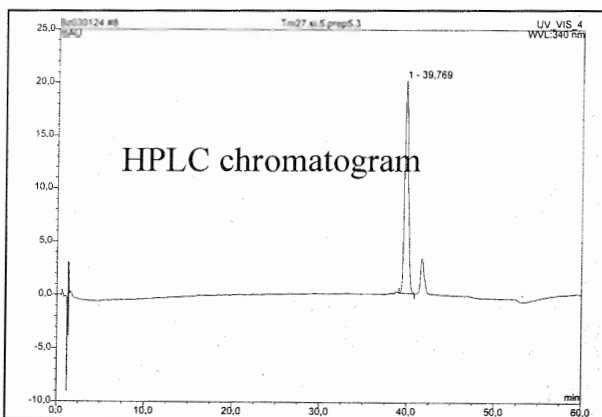
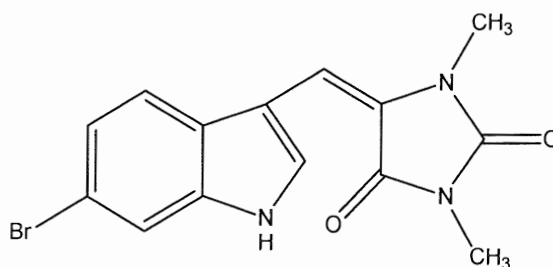

ESIMS: m/z 332/334 [M-H]⁻ (Negative)

3.3.6 Structure elucidation of 6-bromo-3'-deimino-3-oxoaplysinopsin [20-21]

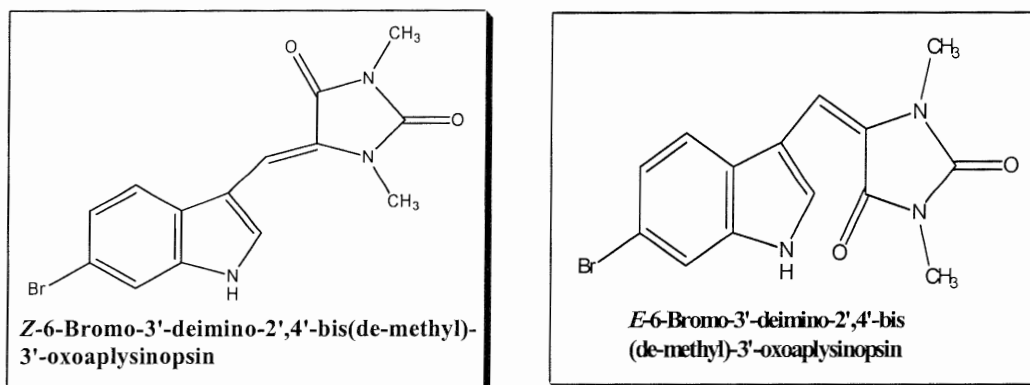

6-Bromo-3-deimino-3-oxoaplysinopsin was perviously isolated from scleractinian corals of the family Dendrophylliidae and it was also synthesized in the laboratory through condensation of 6-bromoindol-3-carboxaldehyde with 1,3-dimethylhydantoin. Naturally, the (*E*) isomer is more common and after photoisomerization it becomes richer in the (*Z*) isomer (Guella *et al.* 1988).

Compounds [20-21] were isolated as a yellow amorphous powder. The UV absorbances were at λ_{\max} 231, 292 and 360 nm. The EIMS spectrum (see Figure 3.3.6.A) showed two peaks at m/z 332/334 $[M-H]^-$ in a ratio of 1:1, which indicated the compound to be monobrominated. Mass and NMR spectra suggested the molecular formula to be $C_{14}H_{12}BrN_3O_2$.

Compound [20-21] were very similar to compound **19** with a difference of one mass unit giving the possibility that instead of a NH, a carbonyl group was substituted at C-3'. The presence of many peaks in the 1H -NMR spectrum (see Figure 3.3.6.B) which were integrated for two protons was explained by the *E/Z* isomer mixture. The spectrum showed also two downfield singlets at 8.85 ppm (1H, s) and 7.55 ppm (1H, s) indicating the proton in the indole ring in the *E*- isomer which is more downfield than that of the *Z*- isomer due to its location near to the carbonyl group. In addition, *meta* coupling protons at 7.61 and 7.27 ppm (2H, d) and *ortho* coupling proton at 7.54 ppm (2H, d) were observed. Furthermore protons at 7.23 ppm (1H, dd) (see Table 3.3.6.A), two olefinic protons at 6.84 and 6.77 ppm in both (*Z*) and (*E*) isomers and four N-CH₃ groups in the aliphatic region at 3.24, 3.08, 2.99 and 2.97 ppm (3H, s) were detected.

Comparison of the NMR data of compounds **[20-21]** with those reported in the literature (Guella *et al.*, 1988) (see Table 3.3.6.B) showed that both spectra were very similar. Thus, it was concluded that the compounds are identical.

Results

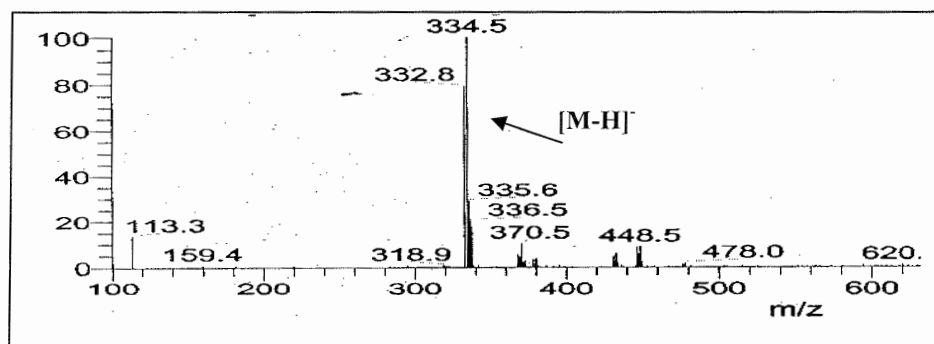

Figure 3.3.6.A: ESI⁻ mass spectrum of compounds [20-21]

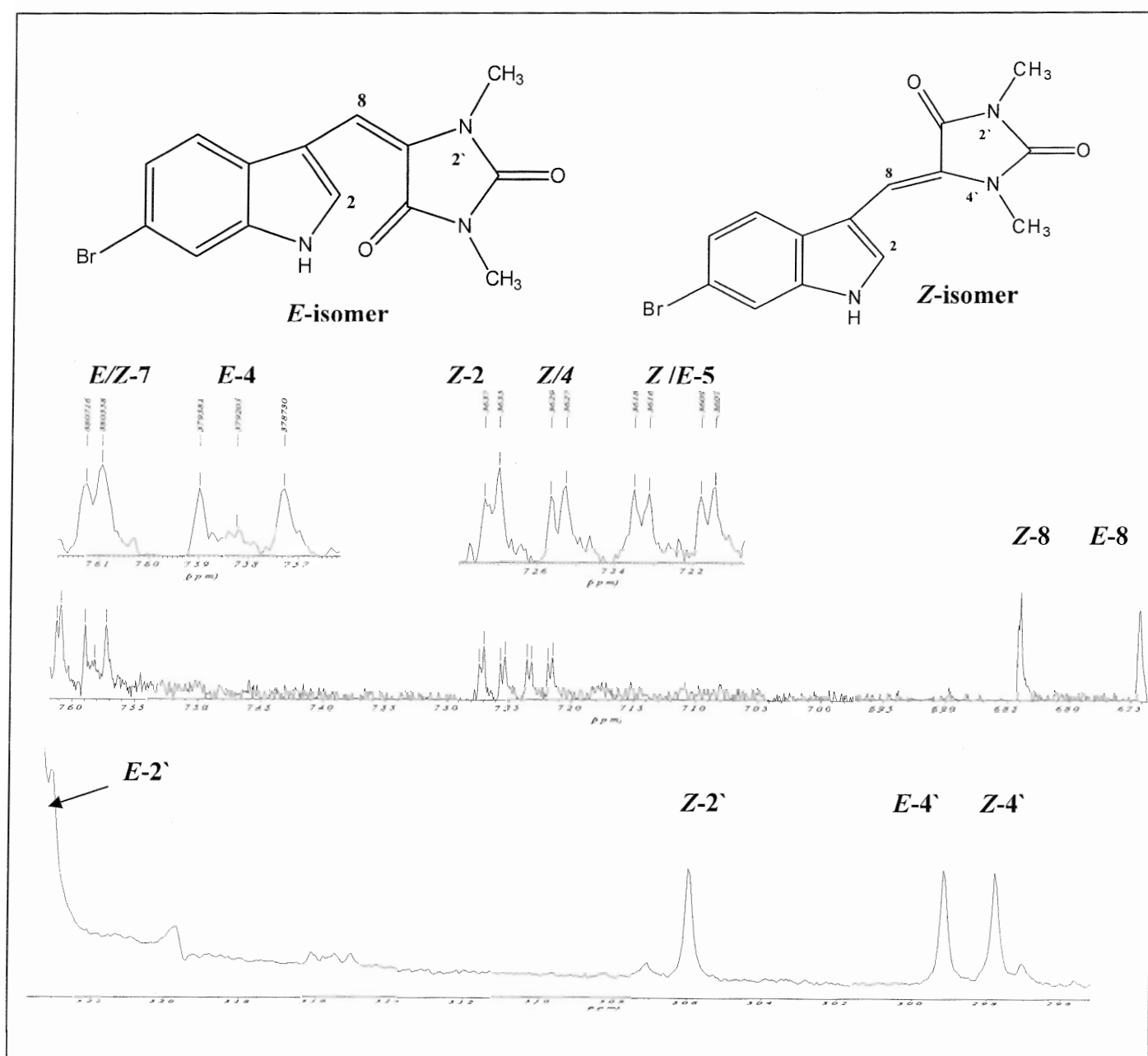

Figure 3.3.6.B: ¹H-NMR spectrum of compounds [20-21]

Results

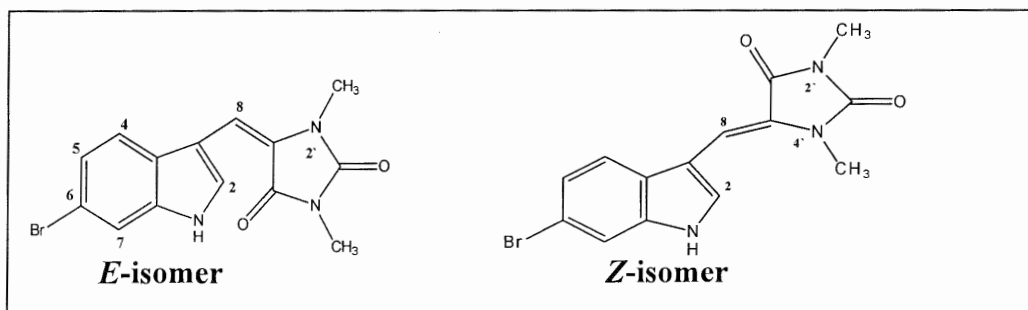

Table 3.3.6.A: ¹H-NMR data of compound [20-21]

¹ H NMR (ppm), multiplicity (Hz)	<i>E</i> -6-bromo-3'-deimino-3'- oxoaplysinopsin (20)	<i>Z</i> -6-bromo-3'-deimino-3'- oxoaplysinopsin (21)
H-2	8.85 (d, <i>J</i> = 2.2 Hz)	7.55 (d, <i>J</i> = 1.4 Hz)
H-4	7.57 (d, <i>J</i> = 7.5 Hz)	7.25 (d, <i>J</i> = 7.5 Hz)
H-5	7.23 (dd, <i>J</i> = 6.9, 2.3 Hz)	7.23 (dd, <i>J</i> = 6.9, 2.3 Hz)
H-7	7.65 (d, <i>J</i> = 7.5 Hz)	7.67 (d, <i>J</i> = 6.9 Hz)
H-8	6.81 (1H, s)	6.84 (1H, s)
CH ₃ -2'	3.24 (3H, s)	3.08 (3H, s)
CH ₃ -4'	2.99 (3H, s)	2.97 (3H, s)

The compound was measured in DMSO-*d*₆.

Table 3.3.6.B: ¹H-NMR data of 6-bromo-3'-deimino-3'-oxoaplysinopsin measured in (DMSO-*d*₆) (Guella *et al.* 1988)

¹ H NMR (ppm), multiplicity (Hz)	<i>E</i> -6-bromo-3'-deimino-3'- oxoaplysinopsin	<i>Z</i> -6-bromo-3'-deimino-3'- oxoaplysinopsin
H-2	8.84 (d, <i>J</i> = 2.8 Hz)	7.70
H-4	7.95 (br. d, <i>J</i> = 7.3 Hz)	7.62
H-5	7.13 (t, <i>J</i> = 7.3 Hz)	7.13
H-7	7.45 (d, <i>J</i> = 7.3 Hz)	7.43
H-8	6.77 (1H, s)	6.89 (1H, s)
CH ₃ -2'	3.00 (3H, s)	2.99 (3H, s)
CH ₃ -4'	3.24 (3H, s)	3.11 (3H, s)

3.3.7 Results of biological assays

3.3.7.1 Protein kinase inhibition test

Several alkaloids were screened in a protein kinase inhibition assay towards cyclin-dependant kinase-1, cyclin-dependant kinase-5 and glycogen synthase kinase-3. The IC₅₀ values in μM for each compound are listed in Table 3.3.7.1.

Table 3.3.7.1: Results of protein kinase inhibition test

Name of compound	IC 50 (μM)		
	CDK-1	CDK-5	GSK-3
<i>E</i> -aplysinopsin	-	> 10	> 10
<i>E/Z</i> -aplysinopsin	-	> 10	> 10
6-bromoaplysinopsin	-	> 10	> 10
<i>E/Z</i> - 6-bromo-3` deimino-3`-oxoaplysinopsin	-	> 10	> 10

3.3.7.2 Cytotoxicity test

Some of the alkaloids isolated from the sponge *Fascaplysinopsis reticulata* were screened for cytotoxic activity towards different cell lines (L518y, HE1A and PC 12). The incubation with the compounds was for 72 hrs. The % of growth inhibition for each compound is shown in Table 3.3.7.2.

Table 3.3.7.2: Results of the Cytotoxicity test 10 $\mu\text{g/ml}$

Name of compound	Growth inhibition in %		
	L5178Y	HE1A	PC 12
6-dimethylaminopurine	0	0	0
7-methyl-6-methylamino-7,9-dihydro-purin-8-one	48 %	0	0
2-(6-bromo-1-methyl-1H-indol-3-yl)-acetamide	74 %	60 %	20 %
<i>E/Z</i> -aplysinopsin	0	0	0
<i>E</i> -aplysinopsin	100 %	56 %	45 %
6-bromoaplysinopsin	100 %	77 %	27 %

3.4 Cyclic peptides from the tunicate *Lissoclinum patella*.

Tunicates are marine animals of the phylum Chordata, which also includes the vertebrates. The adult form of most tunicates (also called urochordates) shows no resemblance to vertebrate animals, but such a resemblance is evident in the larvae. The most familiar tunicates are the sea squirts or ascidians (class Ascidiacea). Adult sea squirts are sedentary, filter-feeding, cylindrical or globular animals, usually found attached to rocks, shells, pilings, or boat bottoms. The soft body is surrounded by a thick test or tunic, often transparent or translucent and varying in consistency from gelatinous to leathery. The tunic (for which the tunicates are named) is secreted by the body wall of the adult animal. It is composed of cellulose, an almost unique occurrence of that material in the animal kingdom. Two siphons project from the animal's body; water enters the incurrent siphon at the top of the body and leaves the excurrent siphon at the side. Food particles are filtered from the water by the pharynx, which occupies most of the body, and are then passed into the digestive system. Some species reproduce by budding, resulting in the formation of colonies of sea squirts, joined at their bases by slender stalks or embedded in a slab of common tunic material. In addition, nearly all species reproduce sexually and are hermaphroditic (Monniot F., 1983).

Tunicates of the genus *Lissoclinum* have been proven to be a rich source of novel secondary metabolites; many of them are biologically active (Sesin *et al.*, 1987). To date, three distinct classes of compounds have been reported. *Lissoclinum vareau*, collected in the Fiji Islands. It is the source of the heteroaromatic pigments varamine A and varamine B (see Figure 3.4) *Lissoclinum patella* Gottschatt, 1898 (Didemnidae) has produced both cyclic peptides.

A common trademark of all *L. patella* metabolites is the presence of a thiazole ring and often an oxazoline ring, in exception to the compound lissoclinolide which was isolated from the species *Lissoclinum soclinum*.

Cyclic peptides from *Lissoclinum* species have been grouped into four main structural types: ulithiacyclamides, patellamides, lissoclinamides and tawicyclamides, according to the number of amino acids and inclusion of thiazole (Thz), thiazoline (Thn) and oxazoline (Oxn) rings within their structure.

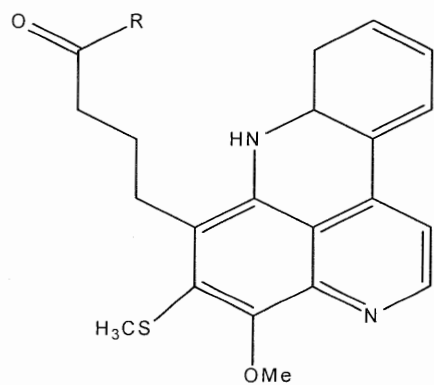

veramine A (R= Et)
veramine B (R= Me)

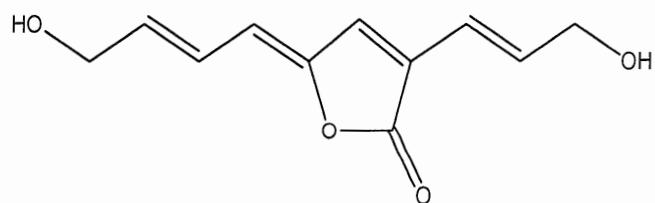

lissoclinolide

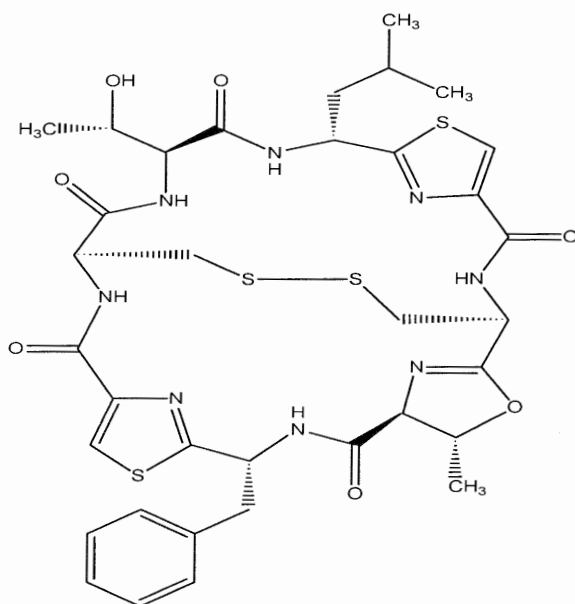

ulithiacyclamide F

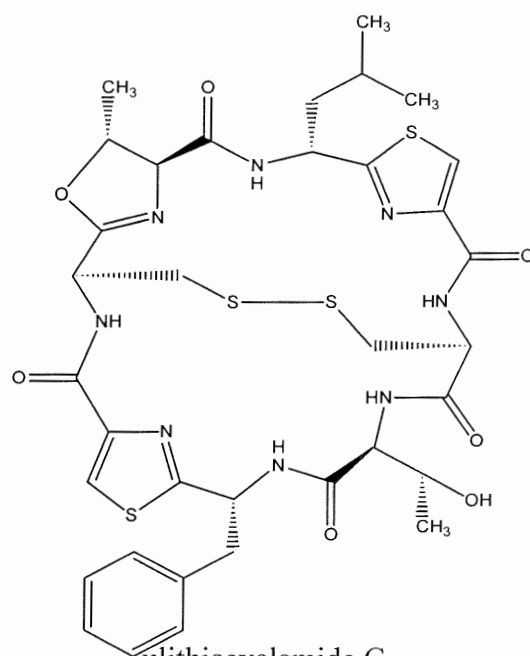

ulithiacyclamide G

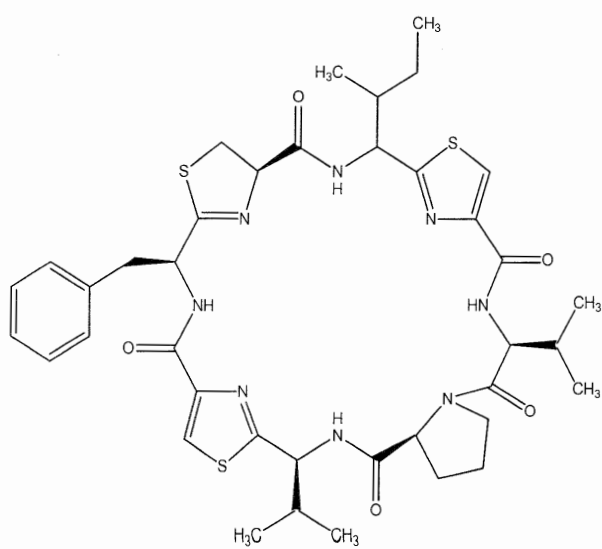

twaicyclamide A

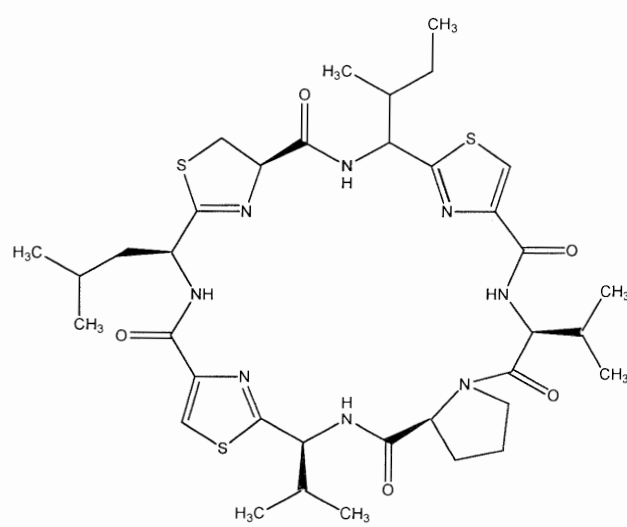

twaicyclamide B

Figure 3.4: Some compounds isolated from *Lissoclinum patella*.

Preulicyclamide (compound 22)

Character: pale yellow oil

Amount: 7 mg

Sample code: TM 34 95/5-5

Molecular weight: 695 g / mol

Biological source: marine tunicate *Lissoclinum patella* (TM 34)

Molecular formula: C₃₃H₄₁N₇O₆S₂

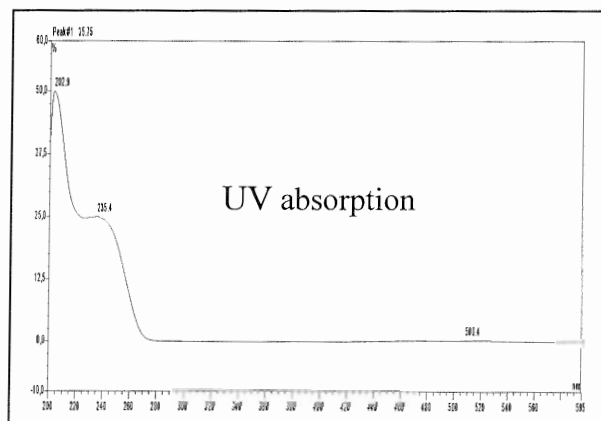
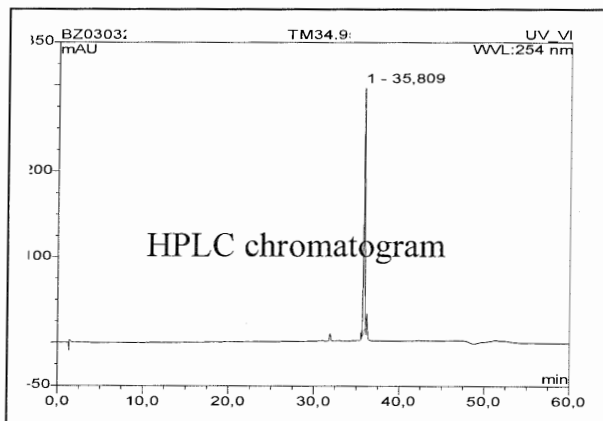
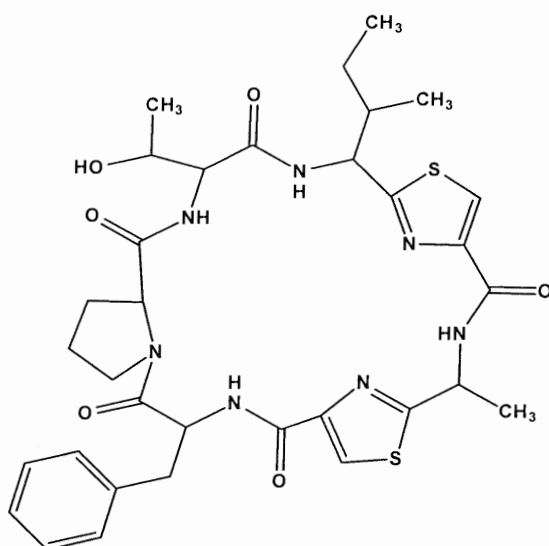

ESIMS: m/z 695 [M+H]⁺ (Positive)

3.4.1 Structure elucidation of preulicyclamide [22]

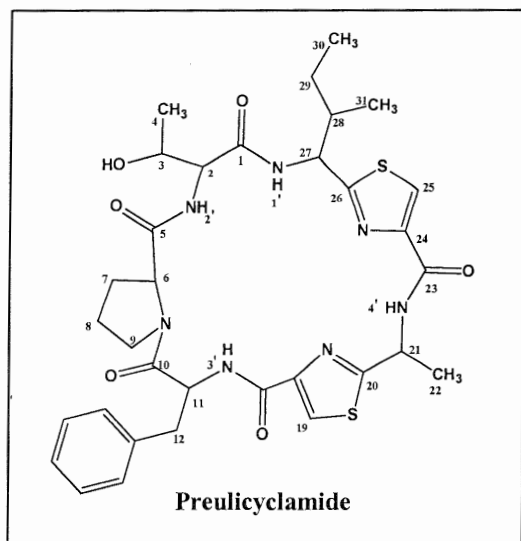

Preulicyclamide is a cyclic hepta peptide, which consist of six different amino acids threonine (thr), alanine (ala), isoleucine (ile), phenylalanine (phe), proline (pro) and two cysteine amino acids (cys); the cysteine residues have cyclised to give two thiazole rings. Preulicyclamide was also isolated from *Lissoclinum patella* in the year 1986 by Sesin (Sesin *et al.*, 1987) and showed high cytotoxicity against cancer cell lines.

Compound [22] was isolated as a pale yellow oil. It has UV absorbances at λ_{max} 203 and 234 nm. The positive ESIMS spectrum showed the pseudo-molecular ion peak at m/z 696 $[M+H]^+$ (see Figure 3.4.1.A). This together with the NMR spectra suggested the molecular formula $C_{33}H_{41}N_7O_6S_2$.

The 1H -NMR spectrum (see Figure 3.4.1.B) exhibited two sharp olefenic protons of the two thiazole rings at 8.28 and 8.32 ppm (1H, s), four methyl groups at 0.70, 0.78, 1.10 and 1.60 ppm (see Table 3.4.1.A), as well as the phenyl ring system of phenylalanine at 7.33 ppm (4H, m) and at 7.25 ppm (1H, m). Four NH signals were observed at 8.05, 8.51, 8.65 and 9.20 ppm and showed coupling to signals in the upfield region typical for α - protons of amino acids. The ^{13}C NMR and HMQC spectra (see Figure 3.4.1.C) exhibited the positions of the five carbonyl groups at 171.9, 170.8, 170.1, 168.9 and 159.9 ppm, the phenyl carbons at 127.0 and at 136.2, the four methyl groups at 8.22, 15.63, 20.7 and 23.3 ppm and the two carbons C-19 and C-25 of the thiazole rings at 123.7 and 124.7 ppm, respectively.

The spin system of each amino acid was confirmed by the COSY spectrum (see Figure 3.4.1.D), which exhibited the cross peaks for the correlation of each α - proton of each amino acid. Furthermore, it showed each correlation of each proton to its neighbouring protons. The

Results

TOCSY spectrum (see Figure 3.4.1.E) exhibited the cross peaks for each proton with every protons that is present in the same spin system. It showed for example the cross peaks of H-3 in the amino acid threonine with all the protons that are present in the threonine residue including H-2, CH₃-4, NH-2 and OH. Also H-6 in the proline amino acid showed cross peaks with H-7_{a/b}, H-8_{a/b} and with H-9_{a/b}. Through the HMBC spectrum (see Figure 3.4.1.F) the amino acid sequence of the cyclic peptide was confirmed. It exhibited the cross peaks of CH₃-4 with C-5, C-9 and C-12, also it showed the cross peaks of Ile-NH with C-18, also the thiazole proton H-19 with C-23, and also the Ala-NH with C-24 and C-27 with C-23. Comparison of NMR data of compound [22] with data reported by Sesin (Sesin *et al.*, 1987) showed that both spectra were very similar, suggesting that the two compounds are identical.

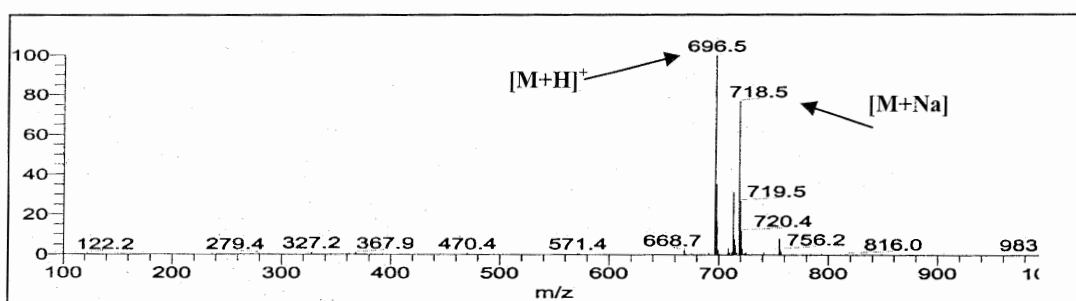

Figure 3.4.1.A: ESI⁺ mass spectrum of prelicyclamide (compound 22)

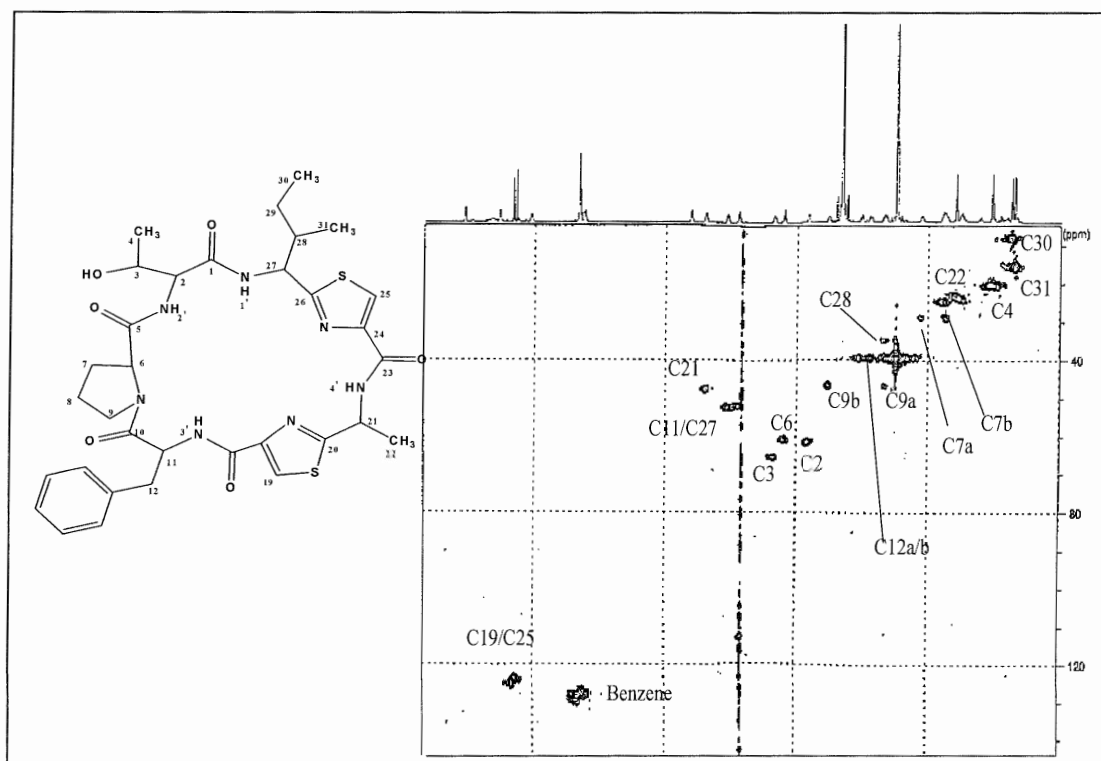

Figure 3.4.1.C: HMBC spectrum of prelicyclamide (compound 22)

Results

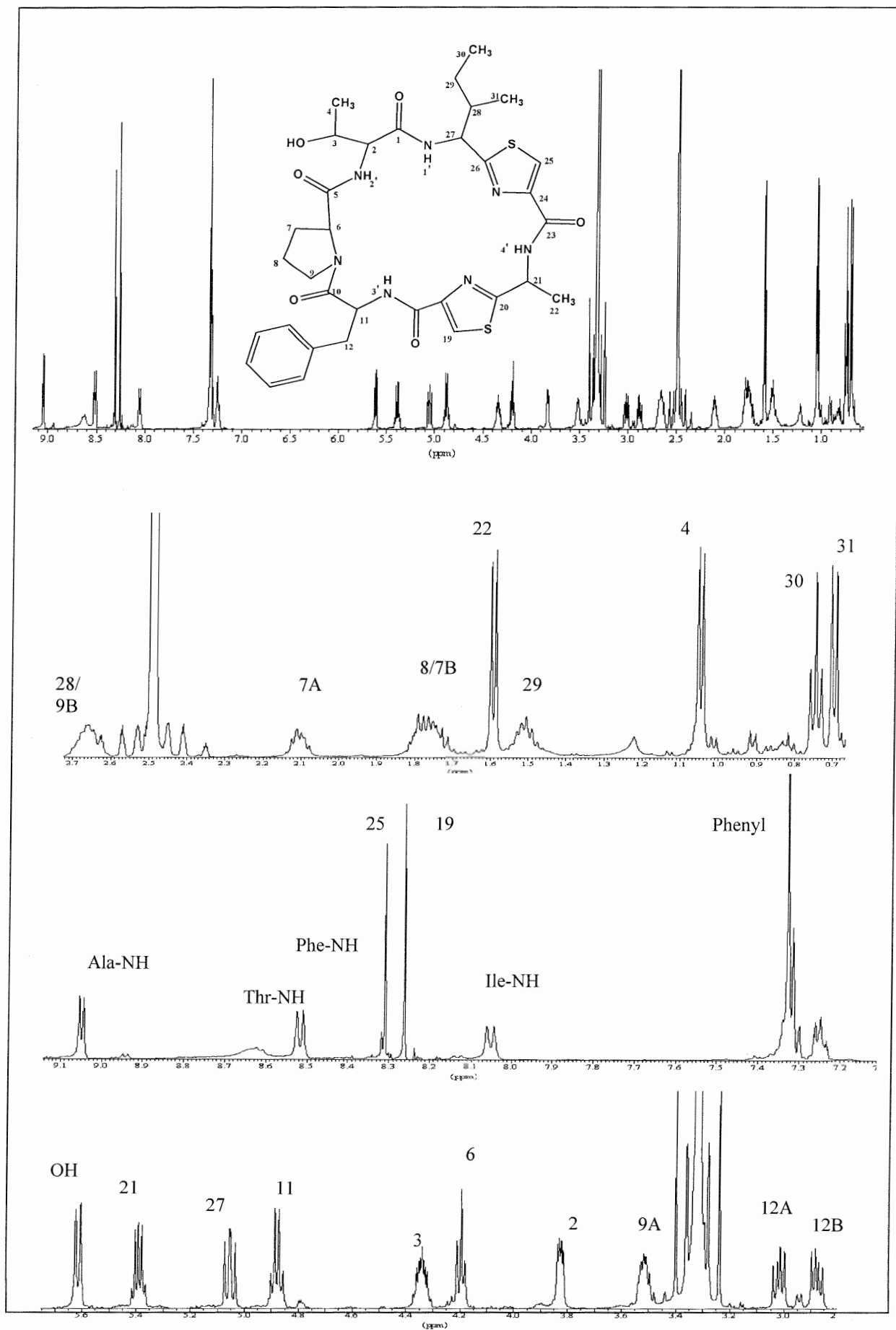

Figure 3.4.1.B: $^1\text{H-NMR}$ spectrum of preucyclamide (compound 22)

Results

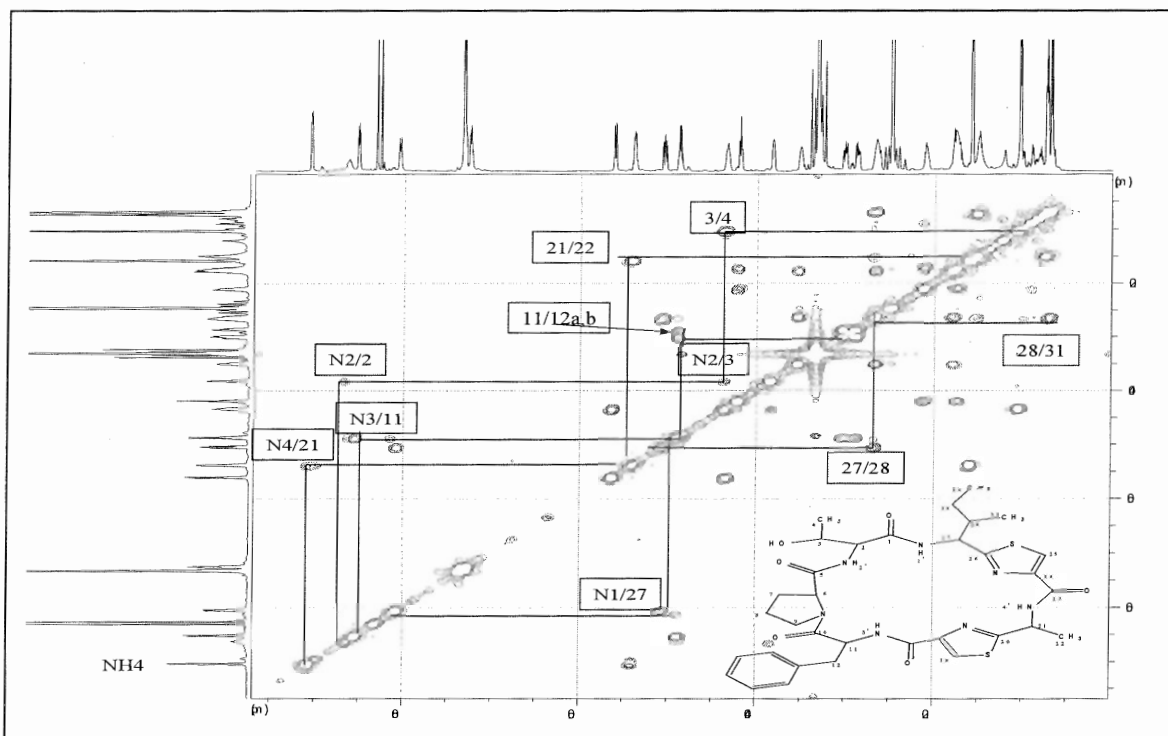

Figure 3.4.1.D: COSY spectrum of preulicyclamide (compound 22)

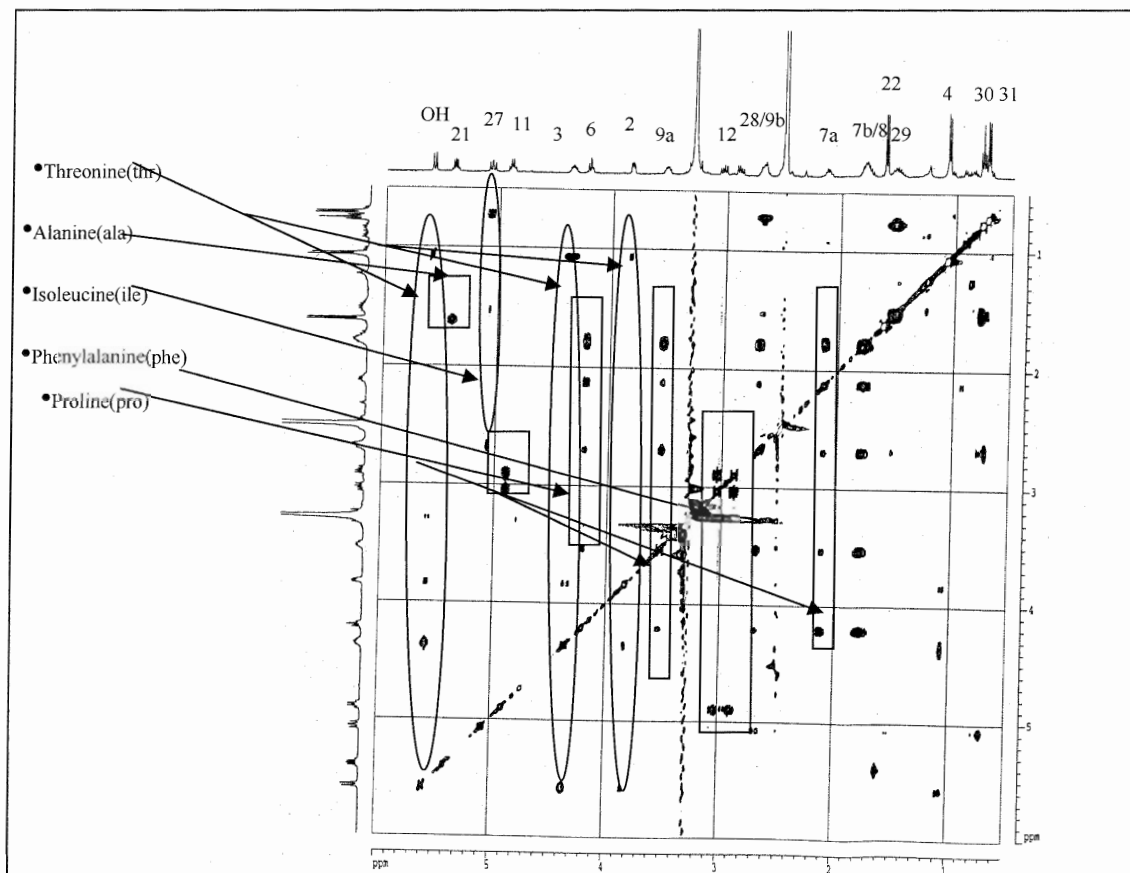

Figure 3.4.1.E: TOCSY spectrum of preulicyclamide (compound 22)

Results

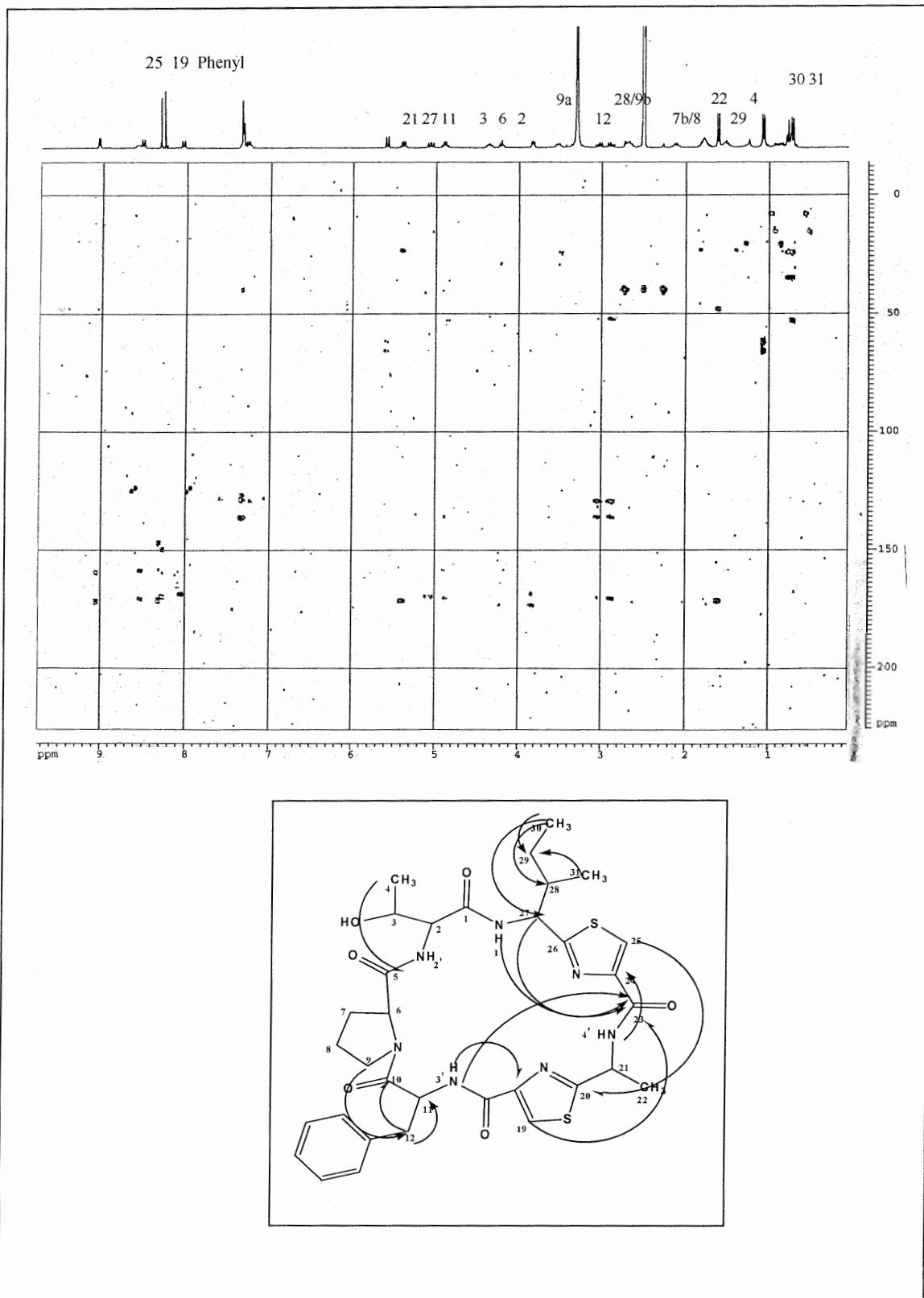

Figure 3.4.1.F: HMBC spectrum of preulicyclamide (compound 22)

Results

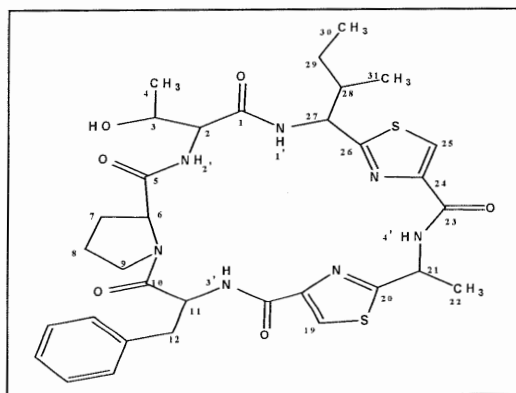

Table 3.4.1.A: NMR data of preulicyclamide (compound 22)

No.	22			
	¹ H NMR (ppm), multiplicity (Hz)	¹ H NMR (ppm), multiplicity (Hz)*	¹³ C NMR (ppm)	HMBC
1	-	-	175.9 s	-
2	3.80 (1H, dd, <i>J</i> = 6.9, 6.9 Hz)	4.03 (1H, dd, <i>J</i> = 7.4, 6.6 Hz)	61.4 d	23, 5
3	4.35 (1H, m)	4.70 (1H, dq, <i>J</i> = 7.4, 6.6 Hz)	65.7 d	-
4	1.05 (3H, d, <i>J</i> = 6.3 Hz)	1.19 (3H, d, <i>J</i> = 6.6 Hz)	20.5 q	2, 3, 5
5	-	-	171.9 s	-
6	4.20 (2H, t, <i>J</i> = 7.5 Hz)	4.17 (2H, dd, <i>J</i> = 8.7 Hz)	60.7 d	-
7A	2.12 (1H, m)	2.17 (1H, m)	29.1 t	-
7B	1.75 (1H, m)	1.90 (1H, m)		
8	1.80 (2H, m)	1.80 (2H, m)	24.8 t	9
9A	3.52 (1H, m)	3.31 (1H, m)	46.9 t	12
9B	2.65 (1H, m)	2.17 (1H, m)		
10	-	-	170.1 s	
11	4.88 (1H, dd, <i>J</i> = 7.5, 6.9 Hz)	4.96 (1H, ddd, 9.5, 8.5 Hz)	52.3 d	
12A	3.05 (dd, <i>J</i> = 13.1 Hz)	3.18 (dd, <i>J</i> = 13.5 Hz)	39.5 t	11, 10
12B	2.92 (dd, <i>J</i> = 13.2 Hz)	2.98 (dd, <i>J</i> = 13.5 Hz)		
13-16	7.35 (5H, m)	7.35 (5H, m)	128.3 m	
17	-	-	169.2	
18	-	-	158.9 s	
19	8.28 (1H, s)	7.89 (1H, s)	123.7 d	23, 26
20	-	-	147.5 s	
21	5.40 (1H, m)	5.31 (1H, m)	47.8 d	29
22	1.60 (3H, d, <i>J</i> = 6.3 Hz)	1.64 (3H, d, 6.3 Hz)	23.4 q	10
23	-	-	168.9 s	
24	-	-	159.8 s	
25	8.32 (1H, s)	8.06 (1H, s)	124.7 d	20, 10
26	-	-	150.0 s	
27	5.05 (1H, dd, <i>J</i> = 10.7 Hz)	5.18 (1H, dd, <i>J</i> = 10.7 Hz)	52.5 d	23
28	2.70 (1H, m)	2.70 (1H, m)	36.5 d	
29	1.51 (2H, m)	1.80 (2H, m)	24.1 t	
30	0.75 (3H, t, <i>J</i> = 7.5 Hz)	0.86 (3H, t, 7 Hz)	8.2 q	29, 28, 27
31	0.70 (3H, d, <i>J</i> = 6.3 Hz)	0.71 (3H, d, 6.6 Hz)	15.6 q	29, 28
NH-1	8.05 (d, <i>J</i> = 8.8 Hz)	-	-	23
NH-2	8.65 (br.s)	-	-	25
NH-3	8.52 (d, <i>J</i> = 8.1 Hz)	-	-	18, 23
NH-4	9.06 (d, <i>J</i> = 5.6 Hz)	-	-	10, 24

The compound was measured in DMSO-*d*₆

* Measured by Sesin (Sesin *et al.*, 1987) in (CDCl₃)

Preliissoclinamide-2 (compound 23)

Character: pale yellow oil

Amount: 3 mg

Sample code: TM 34 95/5-4

Molecular weight: 697 g / mol

Biological source: marine tunicate *Lissoclinum patella* (TM 34)

Molecular formula: C₃₃H₄₃N₇O₆S₂

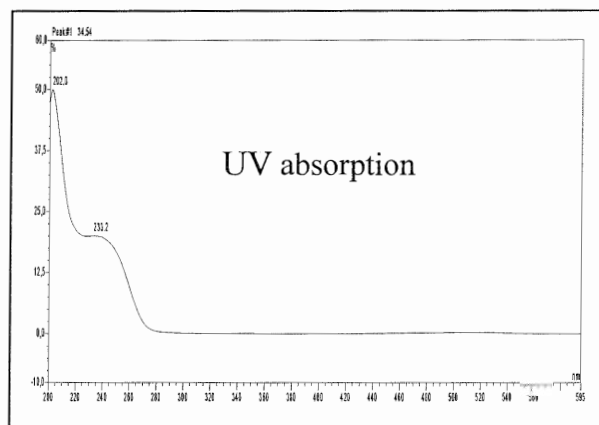
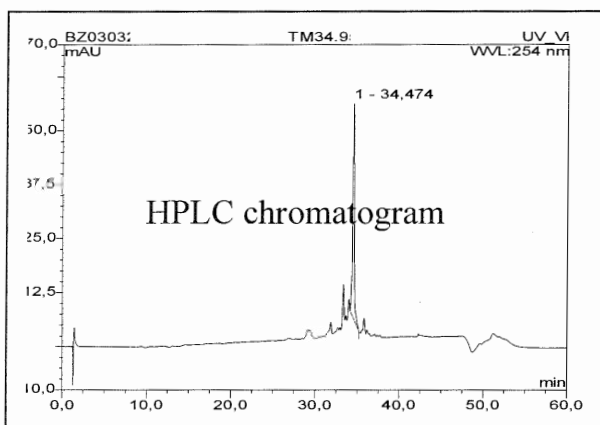
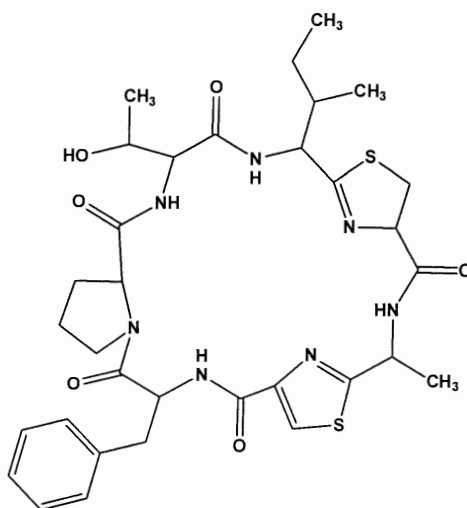

ESIMS: m/z 698 [M+H]⁺ (Positive)

3.4.2 Structure elucidation of prelissoclinamide-2 [23]

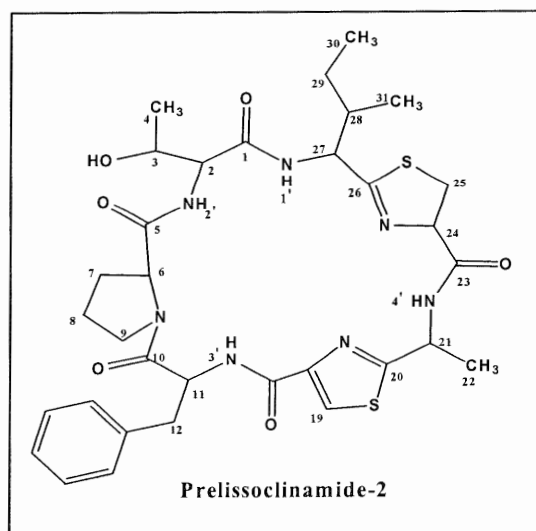

Prelissoclinamide-2 is also a cyclic hepta peptide as compound **22**, which consist of six different amino acids [threonine (thr), alanine (ala), isoleucine (ile), phenylalanine (phe), proline (pro) and two cysteine moieties]; the cysteine residues have cyclised to thiazole and thiazoline rings. Prelissoclinamide-2 was also isolated from *Lissoclinum patella* in the year 1986 (David *et al.*, 1986) and was shown to have high cytotoxicity against cancer cell lines. Compound **[23]** was isolated as a pale yellow oil. It has UV absorbances at λ_{max} 201 and 234 nm. The positive ESIMS spectrum showed the pseudo-molecular ion peak at m/z 698.6 $[M+H]^+$ (see Figure 3.4.2.A). It differed by two mass units from that of compound **22**. The NMR spectra of compound **23** showed one thiazoline ring instead of one thiazole ring as in compound **22**. The mass information taken together with the NMR spectra yielded the molecular formula $C_{33}H_{43}N_7O_6S_2$.

The 1H -NMR spectrum (see Figure 3.4.2.B) exhibited one aromatic proton of the thiazole ring at 8.26 ppm (1H, s) and the protons of the thiazoline ring at 5.32 and 3.64 ppm. Furthermore four methyl groups were observed at 0.84, 0.88, 1.10 and 1.42 ppm (see Table 3.4.2.A), as well as the phenyl ring system protons of phenylalanine at 7.35 ppm (5H, m) and four NH signals of 7.87, 8.15, 8.22 and 8.55 ppm. The latter coupled to signals in the upfield region typical for α - protons of amino acids. The ^{13}C -NMR and DEPT spectra (see Figure 3.4.2.C) exhibited the positions of the carbonyl groups at 171.9, 169.2 and 168.9 ppm, and the phenyl carbons at 127.2 ppm and exhibited the methyl groups at 16.2, 21.0, 23.04 and 24.7 ppm. Furthermore, the carbon of the thiazole ring at 124.5 ppm and the carbons of the thiazoline ring at 35.4 and 79.4 ppm were observed.

Results

Comparison of NMR data of compound [23] with these reported by Sesin (Sesin *et al.*, 1987) showed that both spectra were very similar, suggesting that the two compounds are identical.

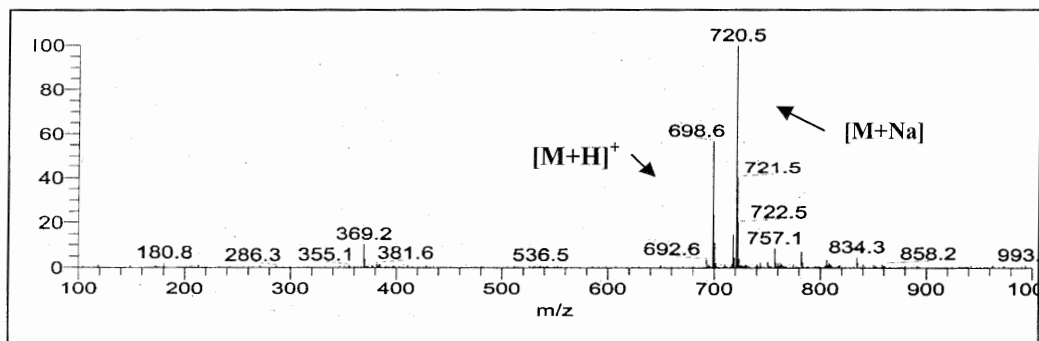

Figure 3.4.2.A: ESI⁺ mass spectrum of preliossoclinamide-2 (compound 23)

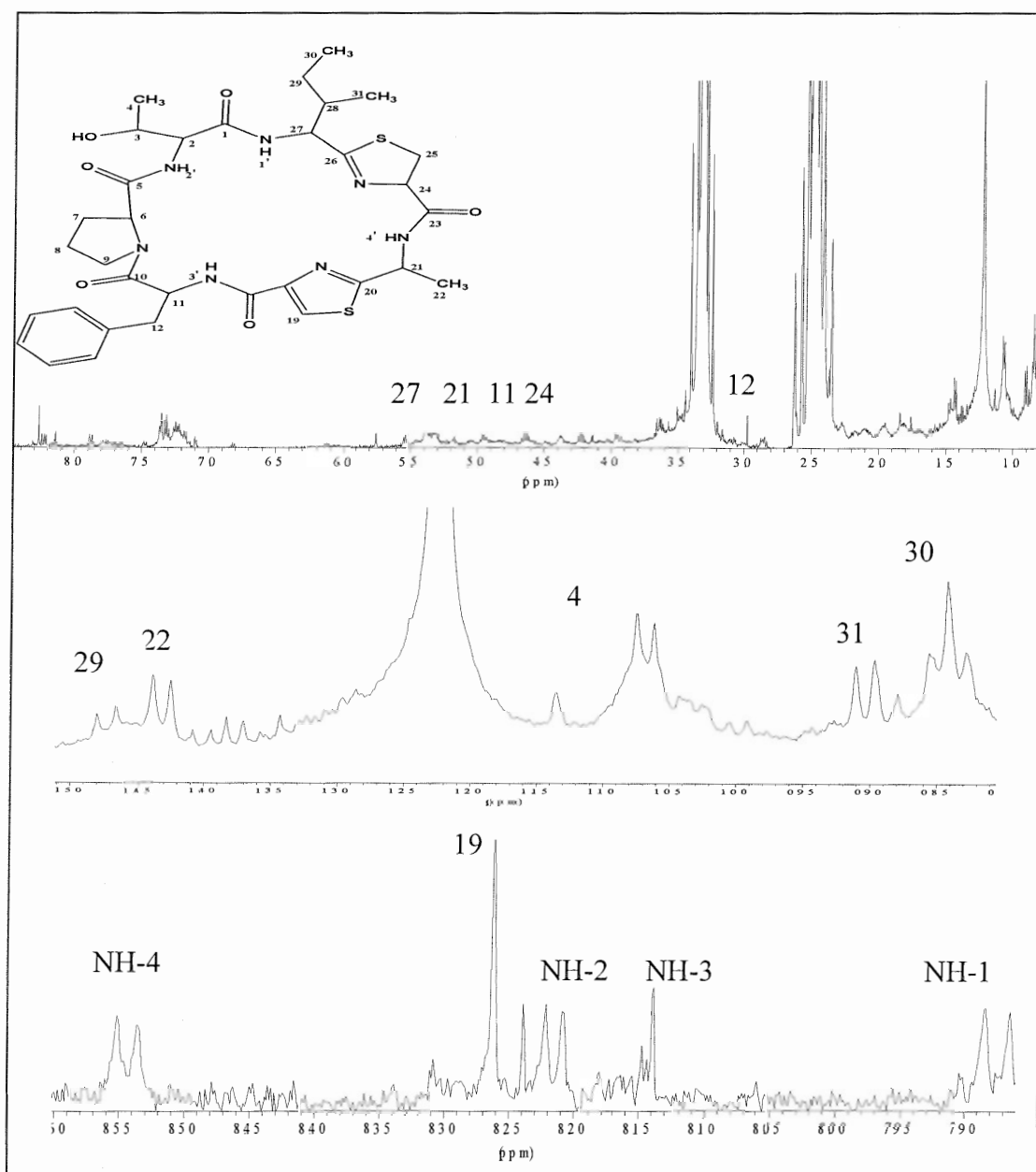

Figure 3.4.2.B: ¹H-NMR spectrum of preliossoclinamide-2 (compound 23)

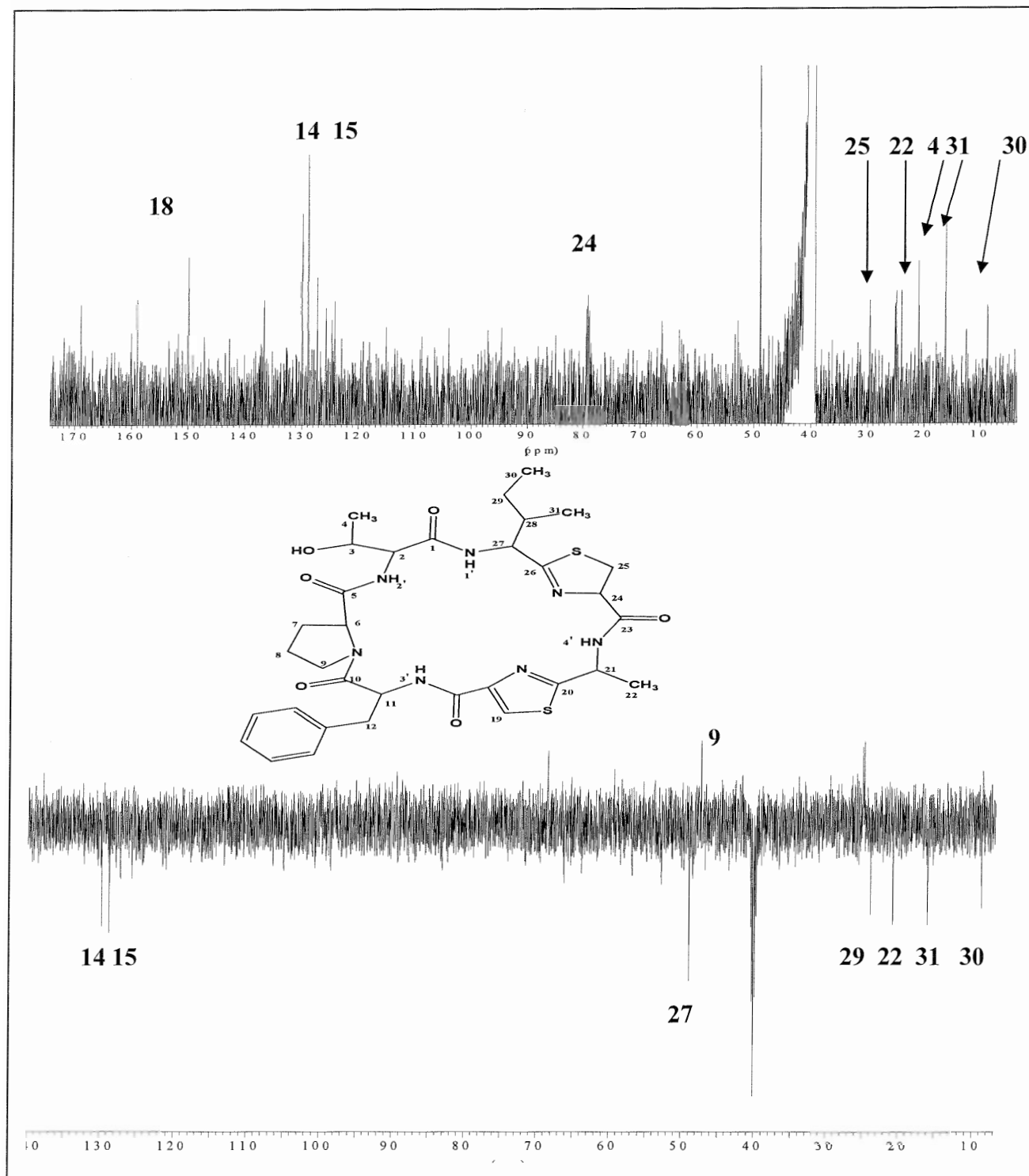

Figure 3.4.2.B: ^{13}C and DEPT spectra of prelissoclinamide-2 (compound 23)

Results

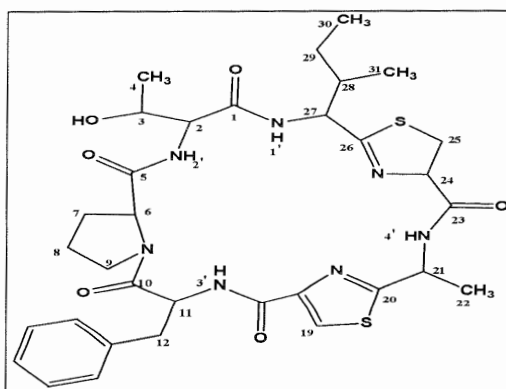

Table 3.4.2.A: NMR data of prelissoclinamide-2 (compound 23)

No	24		
	¹ H NMR (ppm), multiplicity (Hz)	¹ H NMR (ppm), multiplicity (Hz)*	¹³ C NMR (ppm)
1	-	-	-
2	4.65 (1H, dd, <i>J</i> = 6.3 Hz)	4.43 (1H, d, <i>J</i> = 8.7 Hz)	-
3	4.95 (1H, m)	4.84 (1H, m)	66.2 d
4	1.20 (3H, d, <i>J</i> = 6.3 Hz)	1.29 (3H, d, <i>J</i> = 6.5 Hz)	21.0 q
5	-	-	168.9 s
6	4.20 (1H, t, <i>J</i> = 7.5 Hz)	4.30 (1H, t, <i>J</i> = 8.0 Hz)	-
7A	2.31 (1H, m)	2.39 (1H, m)	29.6 t
7B	1.82 (1H, m)	1.84 (1H, m)	-
8	1.80 (2H, m)	1.84 (2H, m)	24.7 t
9A	3.61 (1H, m)	3.59 (1H, m)	47.3 t
9B	2.85 (1H, m)	2.58 (1H, m)	-
10	-	-	171.9 s
11	5.36 (1H, m)	5.18 (1H, m)	52.4 d
12	3.10 (2H, m)	3.15 (2H, m)	-
13-16	7.35 (5H, m)	7.36 (5H, m)	128.8 m
17	-	-	-
18	-	-	149.9 s
19	8.27 (1H, s)	7.95 (1H, s)	124.5 d
20	-	-	-
21	5.40 (1H, m)	5.28 (1H, dq, <i>J</i> = 10.7 Hz)	47.3 d
22	1.42 (3H, d, 6.9 Hz)	1.58 (3H, d, 7.0 Hz)	21.0 q
23	-	-	169.2 s
24	5.32 (1H, m)	5.25 (1H, m)	79.4 d
25	3.65 (2H, s)	3.59 (2H, s)	29.4 t
26	-	-	-
27	5.54 (1H, d, <i>J</i> = 7.5 Hz)	5.33 (1H, dd, <i>J</i> = 8.5 Hz)	52.8 d
28	2.85 (1H, m)	2.58 (1H, m)	-
29	1.48 (2H, m)	1.40 (2H, m)	24.8 t
30	0.82 (3H, t, 6.9 Hz)	0.97 (3H, t, 6.93 Hz)	8.7 q
31	0.90 (3H, d, 6.9 Hz)	1.12 (3H, d, 6.93 Hz)	16.2 q
NH-1	7.87 (d, <i>J</i> = 9.4 Hz)	-	-
NH-2	8.15 (d, <i>J</i> = 4.4 Hz)	-	-
NH-3	8.22 (d, <i>J</i> = 6.3 Hz)	-	-
NH-4	8.55 (d, <i>J</i> = 7.5 Hz)	-	-

The compound was measured in DMSO-*d*₆

*Measured by Sesin (Sesin *et al.*, 1987) in (CDCl₃)

Lissoclinamide-10 (compound 24)

Character: pale yellow oil

Amount: 4 mg

Sample code: TM 34 95/5-6

Molecular weight: 723 g / mol

Biological source: marine tunicate *Lissoclinum patella* (TM 34)

Molecular formula: C₃₆H₄₉N₇O₅S₂

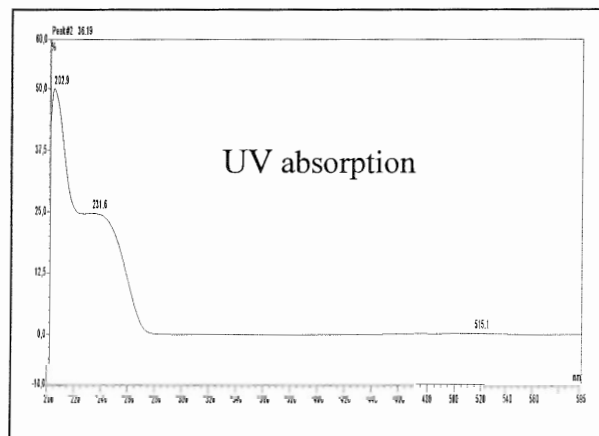
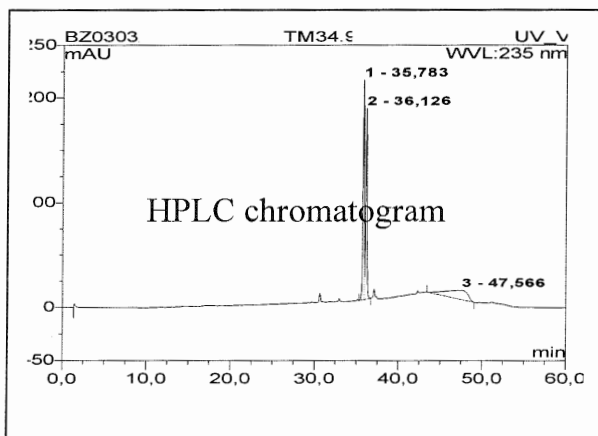
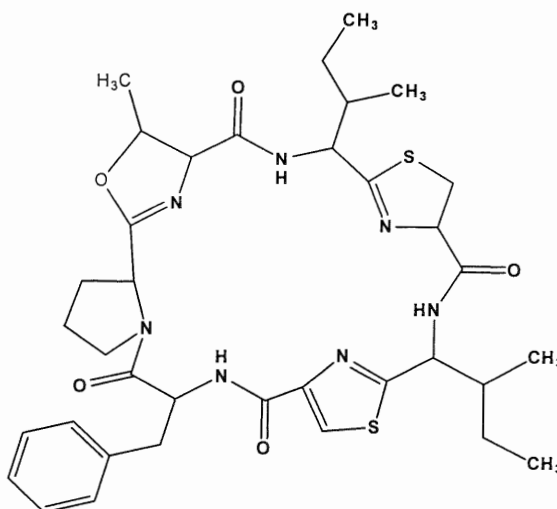

ESIMS: m/z 724 [M+H]⁺ (Positive)

3.4.3 Structure elucidation of lissoclinamide-10 [24].

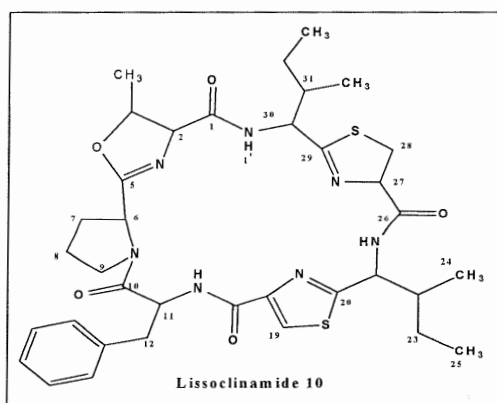

Lissoclinamide 10 is a cyclic hepta peptide and was isolated for the first time in the year 2000 from *Lissoclinum patella*. Lissoclinamide-10 belongs to the group of lissoclinamides that are derived from a cyclic heptapeptide in which the threonine residue has been cyclised to give an oxazoline ring and two cysteines residues have been cyclised to give one thiazoline ring and one thiazole ring.

Compound [24] was isolated as a pale yellow oil. It has UV absorbances at λ_{max} 202 and 231 nm. The positive ESIMS spectrum showed the pseudo-molecular ion peak at m/z 724.5 $[M+H]^+$ (see Figure 3.4.3.A). This together with the NMR spectra suggested the molecular formula $C_{36}H_{49}N_7O_5S_2$.

The $^1\text{H-NMR}$ spectrum (see Figure 3.4.3.B) exhibited three NH doublets at 8.00, 8.52 and 8.95 ppm as well as the protons of the phenyl ring system of phenylalanine at 7.3 ppm. It also revealed the absence of one of the singlets in the aromatic region typical for a thiazole ring thus indicating the presence of a thiazoline system as in compound 23. Furthermore, the spectrum showed an additional methylene group at 1.50 ppm (2H, m) and one methine signal at 2.66 ppm (1H, m) when compared to compound 23. The methyl groups of the two isoleucine units at 0.69, 0.74, 0.82 and 0.91 ppm and the methyl group of the oxazoline ring at 1.05 ppm were likewise observed (see Table 3.4.3.A).

The TOCSY spectrum (see Figure 3.4.3.C) exhibited the cross peaks for each proton with every proton that is present in the same spin system. It showed the cross peaks of H-21 in the amino acid isoleucine with all the protons that are present in the isoleucine residue including CH_3 -24/ 25, H-22 and NH-2. H-6 in the proline residue showed cross peaks with H-7_{a/b}, H-8_{a/b} and with H-9_{a/b}. Also the methyl group of the oxazoline ring showed cross peaks with H-2 and with H-3.

Through the ROESY spectrum (see Figure 3.4.3.D) the amino acid sequence of the cyclic peptide was confirmed. It exhibited the cross peaks of protons of H-11 in the phenylalanine

Results

amino acids with proton 9A in the prolin residue and it showed also a cross peak with the methyl group CH₃-24 in the isoleucin amino acid. Proton H-8 showed a cross peak with the methyl group of the oxazoline amino acid. Comparison of NMR data of compound [24] with those reported by Morris (Morris *et al.*, 2000) showed that both spectra were very similar, suggesting that the two compounds are identical.

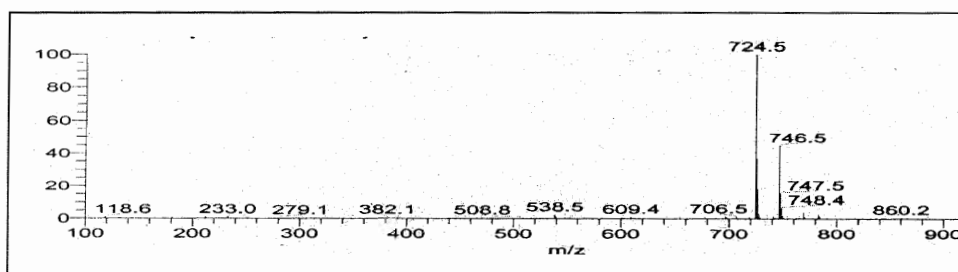

Figure 3.4.2.A: ESI⁺ mass spectrum of lissoclinamide 10 (compound 24)

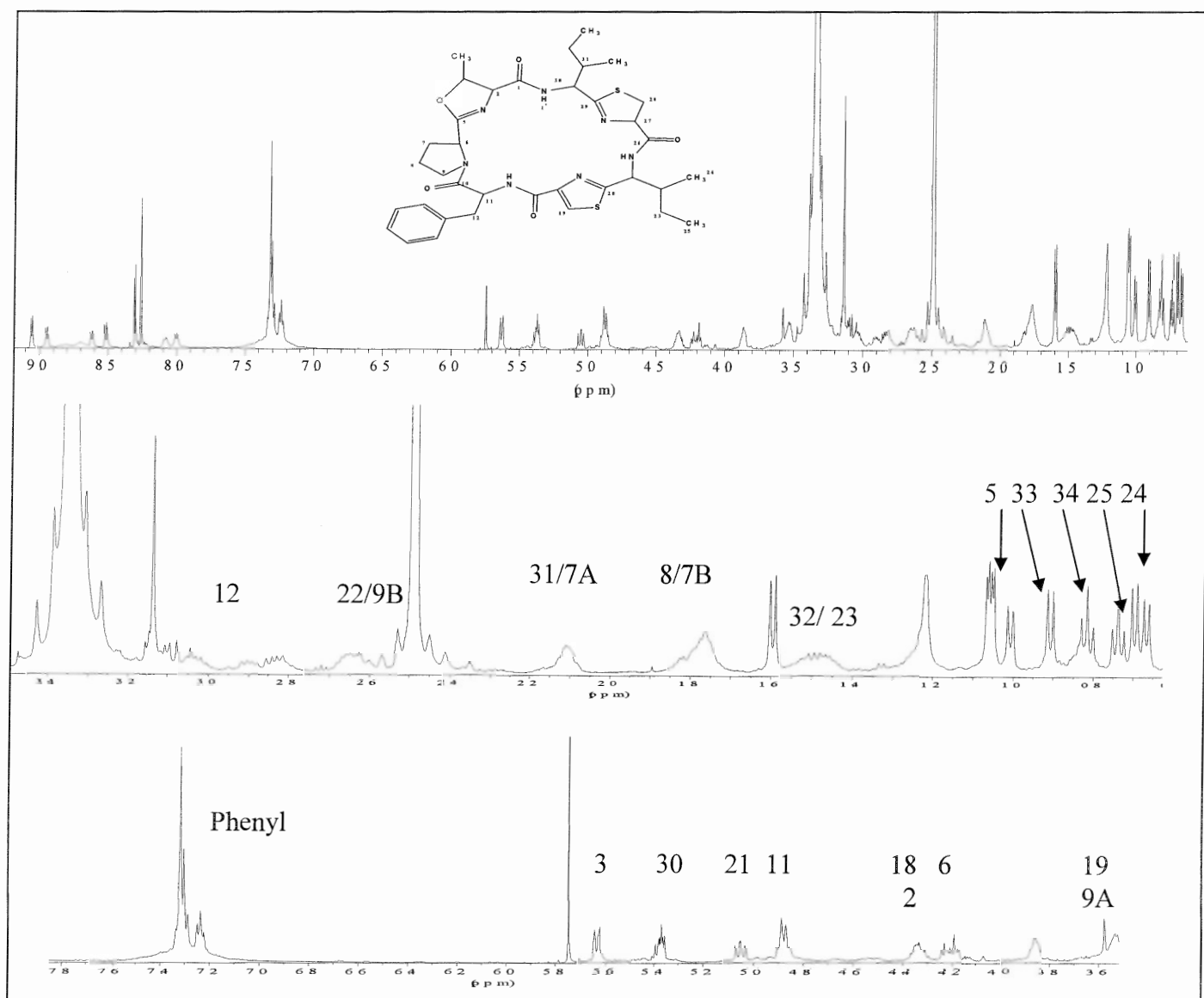

Figure 3.4.3.B: ¹H-NMR spectrum of lissoclinamide 10 (compound 24)

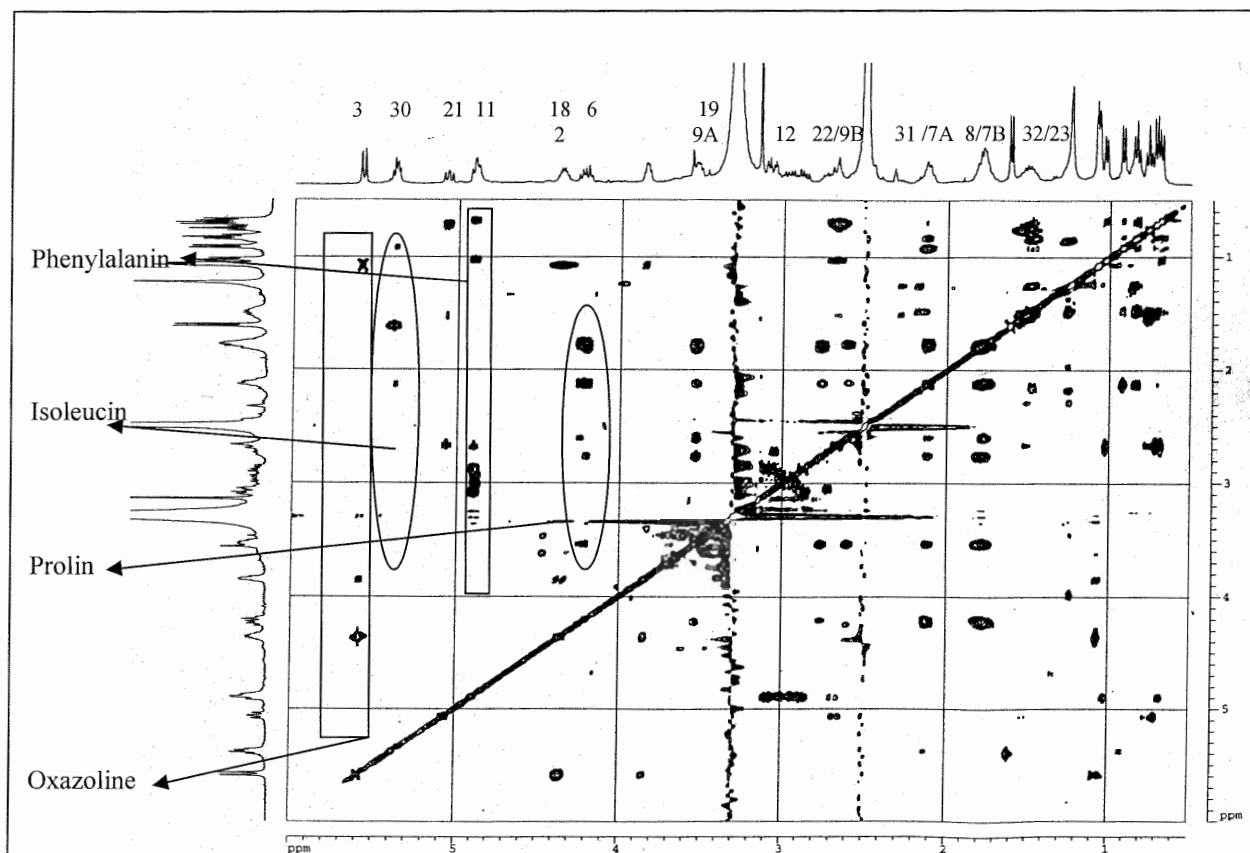

Figure 3.4.3.C: TOCSY spectrum of lissoclinamide 10 (compound 24)

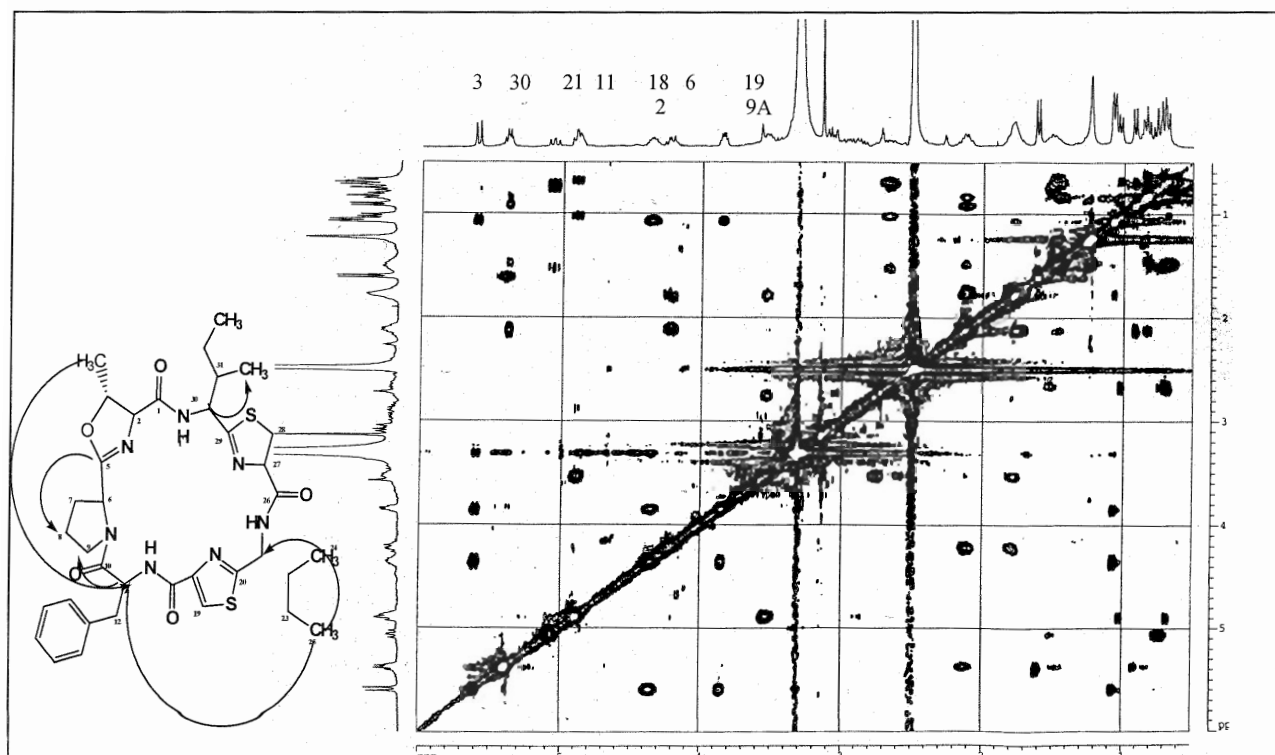

Figure 3.4.3.D: ROESY spectrum of lissoclinamide 10 (compound 24)

Results

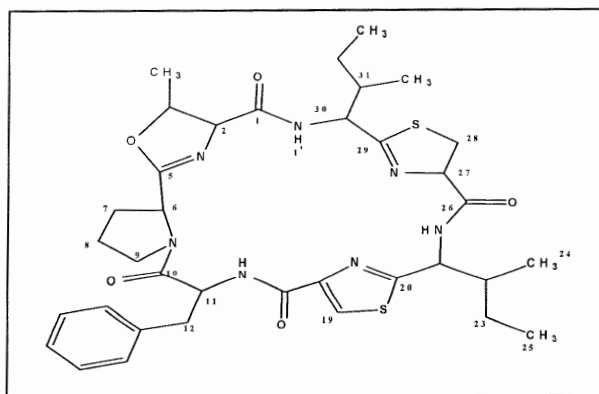

Table 3.4.3.A: NMR data of lissoclinamide 10 (compound 24)

H-No.	¹ H NMR (ppm), multiplicity (Hz)	¹ H NMR (ppm), multiplicity (Hz)*
2	4.32 (1H, m)	4.25 (d, 4.8)
3	5.61 (1H, d, <i>J</i> = 10.0 Hz)	5.46 (1H, d, <i>J</i> = .09 Hz)
5	1.05 (3H, d, <i>J</i> = 6.3 Hz)	1.48 (3H, d, <i>J</i> = 5.4 Hz)
6	4.22 (1H, m)	4.50 (1H, t)
7A, 7B	2.11 (1H, m), 1.78 (1H, m)	2.31 (1H, m), 2.25 (1H, m)
8	1.80 (2H, m)	1.90 (2H, m)
9A, 9B	3.55 (1H, m), 2.65 (1H, m)	3.56 (1H, t), 2.98 (1H, t)
11	4.88 (1H, d, <i>J</i> = 8.1 Hz)	5.01 (1H, dq, <i>J</i> = 9.5 Hz)
12A,12B	2.91 (1H, m), 2.85 (1H, m)	2.88 (1H, m), 2.72 (1H, m)
13-16	7.35 (5H, m)	7.21 (5H, m)
18	4.38 (1H, m)	4.71 (1H, m)
19	3.52 (2H, m)	3.62 (2H, m)
21	5.14 (1H, q, <i>J</i> = 10.7 Hz)	5.17 (1H, m)
22	2.66 (1H, m)	2.44 (1H, m)
23	1.50 (2H, m)	1.46 (2H, m)
24	0.74 (3H, d, <i>J</i> = 6.3 Hz)	0.86 (3H, d)
25	0.71 (3H, t, <i>J</i> = 7.5 Hz)	0.95 (3H, t)
27	4.90 (1H, m)	4.90 (1H, m)
28	3.45 (1H, m)	3.48 (1H, m)
30	5.38 (1H, m)	5.22 (1H, m)
31	2.11 (1H, m)	2.47 (1H, m)
32	1.50 (2H, m)	1.42 (2H, m)
33	0.92 (3H, d, <i>J</i> = 6.9 Hz)	1.14 (3H, d)
34	0.71 (3H, t, <i>J</i> = 7.5 Hz)	0.95 (3H, t)
NH-1	9.51 (d, <i>J</i> = 6.3 Hz)	-
NH-2	8.51 (d, <i>J</i> = 8.2 Hz)	-
NH-3	8.00 (d, <i>J</i> = 8.8 Hz)	-

The compound was measured in DMSO-*d*₆

* Measured by Morris (Morris *et al.*, 2000) in (CDCl₃)

Results

Ulicyclamide (compound 25)

Character: pale yellow oil

Amount: 4 mg

Sample code: TM 34 95/5-8

Molecular weight: 677 g / mol

Biological source: marine tunicate *Lissoclinum patella* (TM 34)

Molecular formula: C₃₃H₃₉N₇O₅S₂

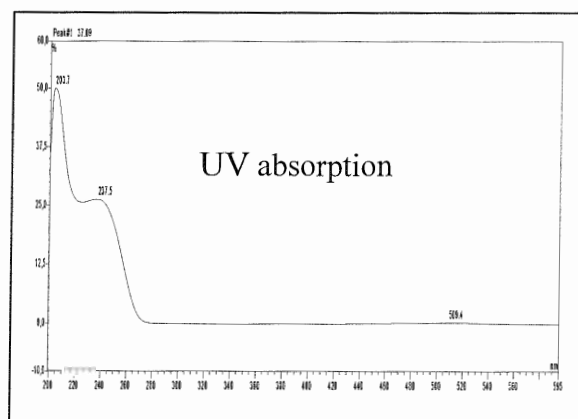
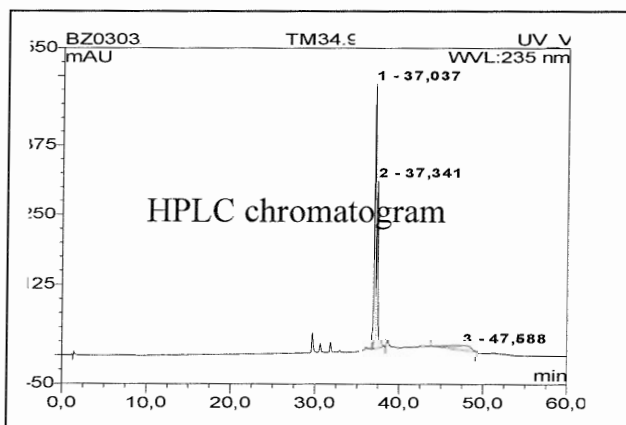
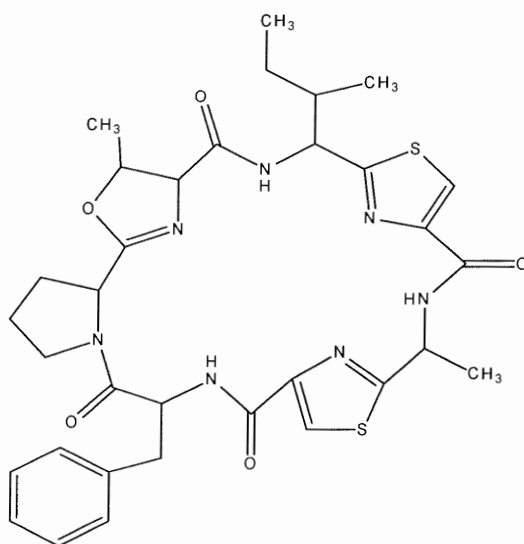

ESIMS: m/z 678 [M+H]⁺ (Positive)

3.4.4 Structure elucidation of lissoclinamide 2 and ulicyclamide [25-26].

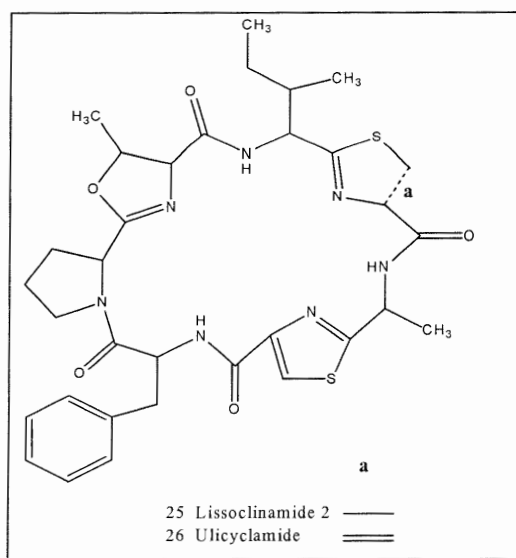

Compounds 25 and 26 were isolated together, both compounds are cyclic peptides that were isolated for the first time in years 1983 and 1988 from *Lissoclinum patella*. Both belong to the group of lissoclinamides, that are derived from a cyclic heptapeptide in which the residue threonine has been cyclised to give an oxazoline ring and two cysteines residue have been cyclised to give a one thiazole ring and one thiazoline ring as in compound [25] and two thiazole rings as in compound [26]. Both compounds have been reported to have a potent cytotoxicity and *in vivo* antitumor activity (Lindel *et al.*, 2000).

Compounds [25 and 26] were isolated as a pale yellow oil. The UV absorbances are observed at λ_{\max} 203 and 235 nm. The positive ESIMS spectrum showed the pseudo-molecular ion peak at m/z 680 $[M+H]^+$ for compound 25 and at 678 $[M+H]^+$ for compound 26 (see Figure 3.4.4.A) with a difference of two mass units from compound 26.

The difference between compounds 26 and 22 is that the threonine residue in compound 22 is converted to oxazoline ring showing a difference of 17 mass units between compound 22 to 26.

The $^1\text{H-NMR}$ spectrum (see Fig.: 3.4.4.B) of compound 26 exhibited two aromatic protons of the two thiazole rings at 8.32 and 8.36 ppm (1H, s), and the protons of the oxazoline ring H-_{2,3} at 4.17, 4.67 ppm, and four methyl groups at 1.62, 1.35, 0.81 and 0.71 ppm, as well as the phenyl ring system of the phenylalanine at 7.35 ppm (5H, m). Furthermore three NH signals at 7.41, 8.49 and 8.99 ppm were observed which are coupled to signals in the upfield region for α - protons of amino acids.

The $^1\text{H-NMR}$ spectrum of compound **25** that is similar to that of compound **26** (see Figure 3.4.4.B) exhibited one singlet of the aromatic proton of the thiazole ring of H₁₉ at 8.31 ppm (1H, s) and signals for the protons of the thiazoline ring of H_{24,25} at 5.41, 3.70 ppm. Furthermore and four methyl groups were observed at 0.84, 0.88, 1.10 and 1.42 ppm. The protons of the phenyl ring system of the phenylalanine at 7.35 ppm (5H, m), and three NH signals at 7.82, 8.61 and 8.91 ppm.

The TOCSY spectrum (see Figure 3.4.4.C) exhibited the cross peaks for each proton in compound **26** with all protons that are present in the same spin system. It showed the cross peaks of H-27 in the amino acid isoleucine with all the protons that are present in the isoleucine residue such as H-28, H-29 and CH₃-30/31, CH₃-22 and NH-3 and H-21. Proton H-6 in the proline amino acid is showing cross peaks with H-7_{a/b}, H-8_{a/b} and with H-9_{a/b}, also the methyl group of the oxazoline showed cross peaks with H-3 and with CH₃-4.

The TOCSY spectrum (see Figure 3.4.4.C) of compound **25** showed cross peaks of H-24 in the thiazoline ring with H-25, and the same cross peaks as in compound **26** were also observed.

The ROESY spectrum (see Figure 3.4.4.D) confirmed the sequence of the amino acids in the cyclic peptide of compound **26**. It exhibited the cross peaks of protons of H-11 in the phenylalanine amino acids with proton 9_a in the proline residue, and proton H-6 showed cross peak with the methyl group of the oxazoline part.

The ROESY spectrum of compound **25** (see Figure 3.4.4.D) showed cross peaks of H-27 in isoleucine with proton CH₃-4 in the oxazoline ring and proton H-2 with in the oxazoline ring with the proton H-11 in the phenylalanine moiety.

Comparison of NMR data of compound [**25-26**] with those reported by Sesin (Sesin *et al.*, 1986) showed that both spectra were very similar, suggesting that the two compounds are identical (see Table 3.4.4.A and B).

Results

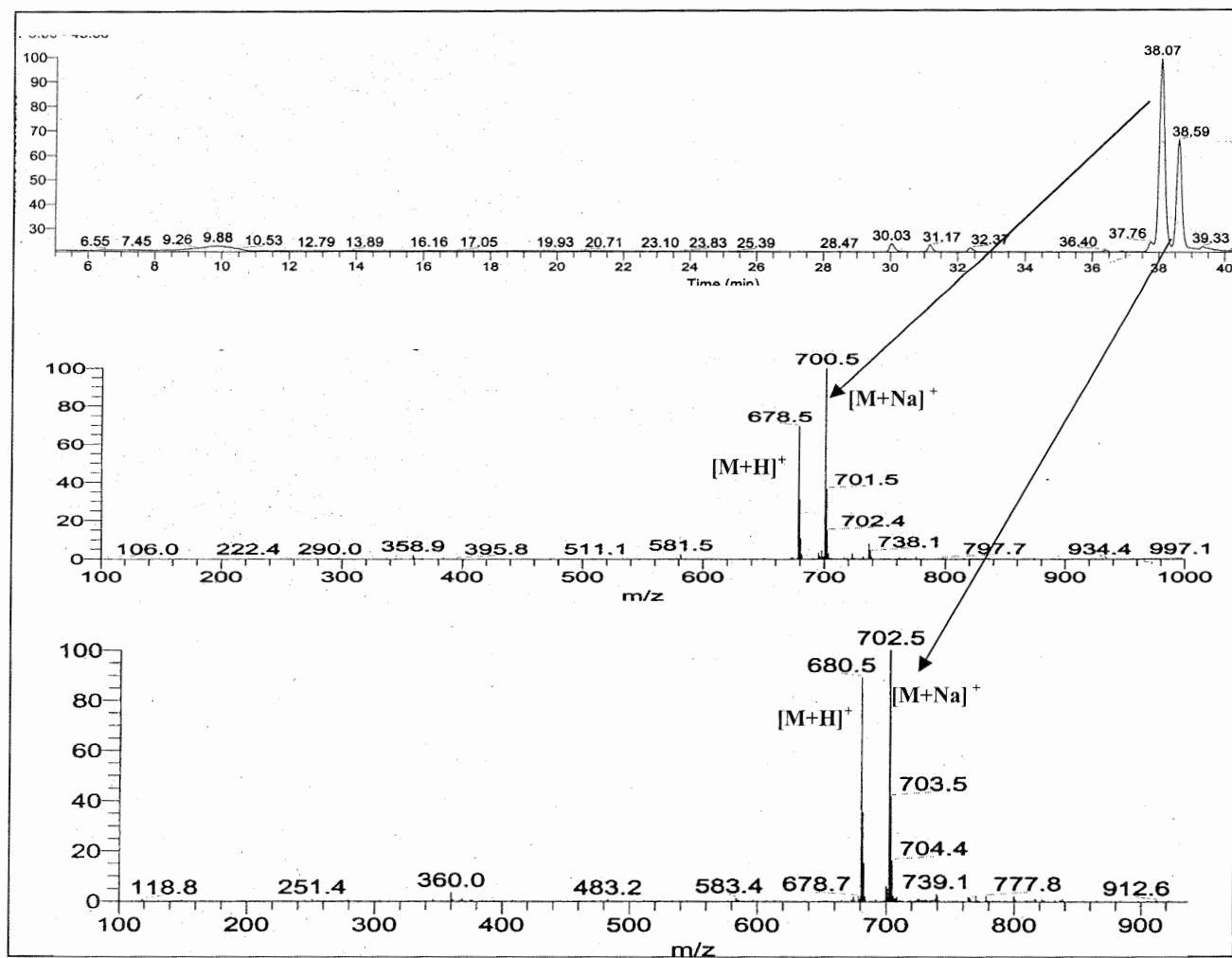

Figure 3.4.4.A: ESI⁺ mass spectrum of compounds 25 and 26

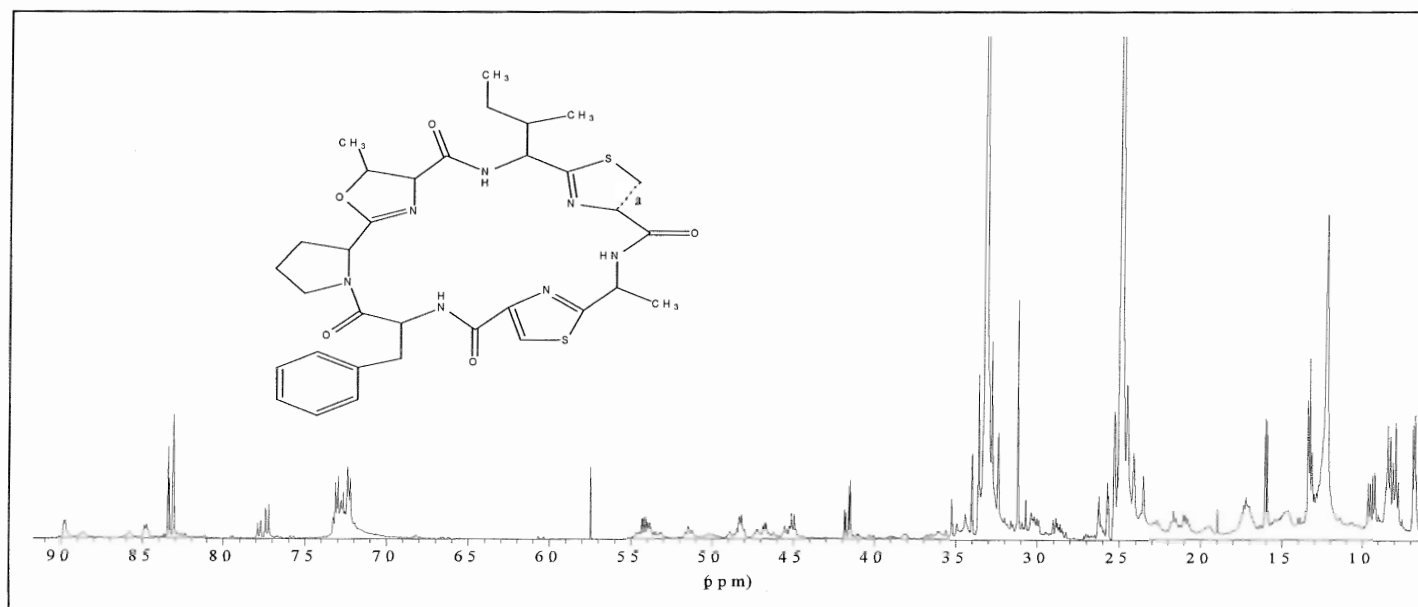

Figure 3.4.4.B: ¹H-NMR spectrum of a mixture of compounds 25 and 26

Results

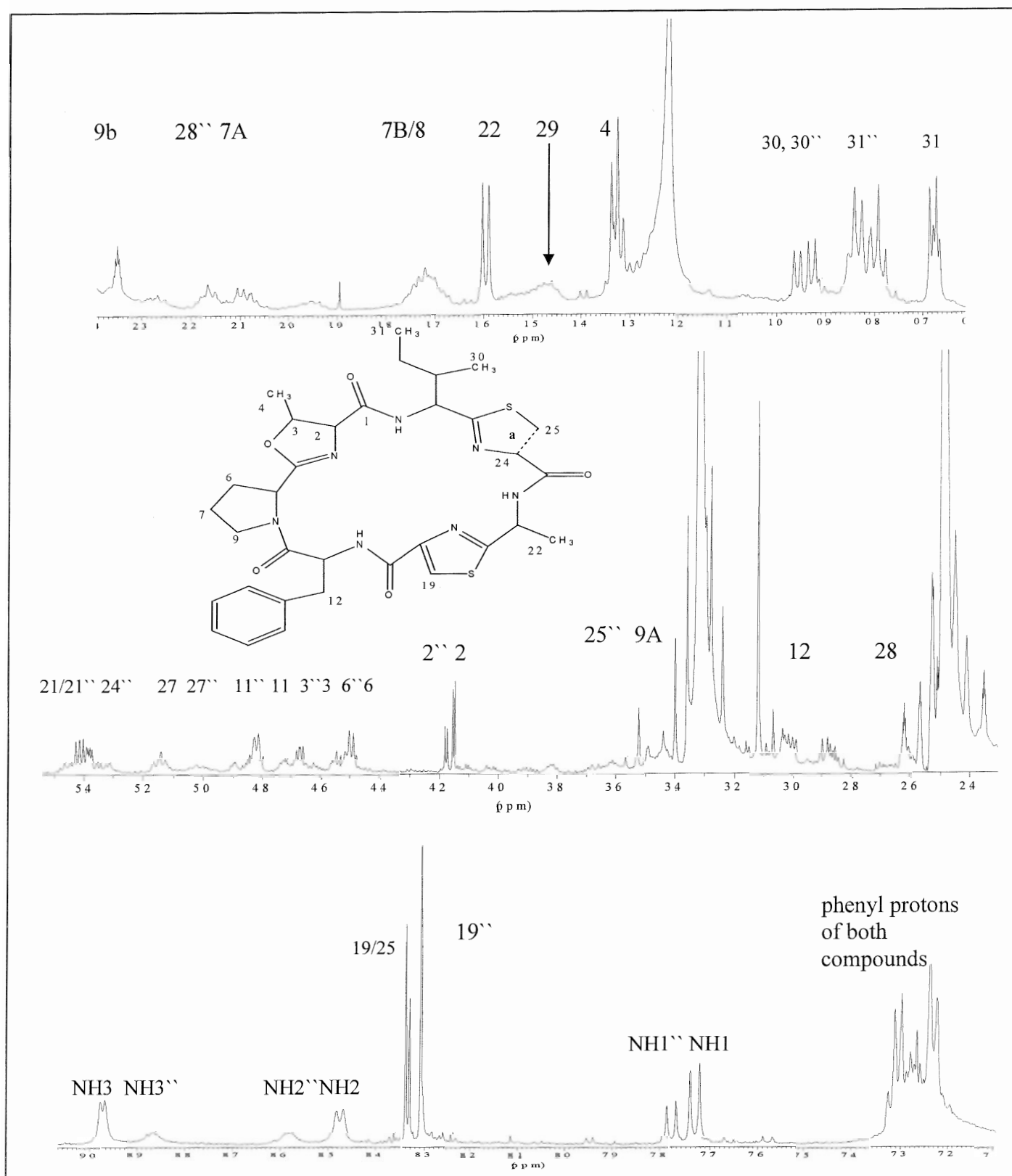

Figure 3.4.4.B: ^1H -NMR spectrum of a mixture compounds 25 and 26

[25] = ()

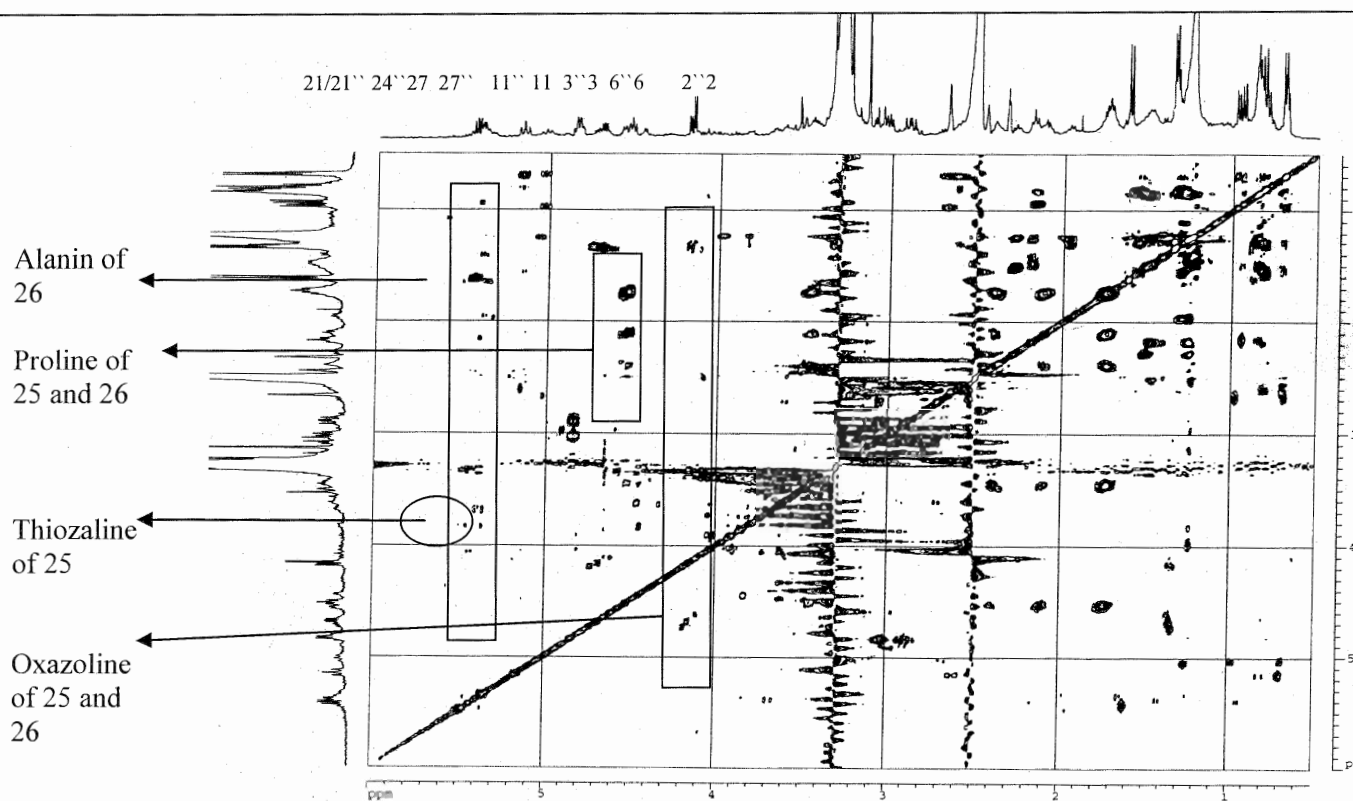

Figure 3.4.4.C: TOCSY spectrum of compound 25 and 26

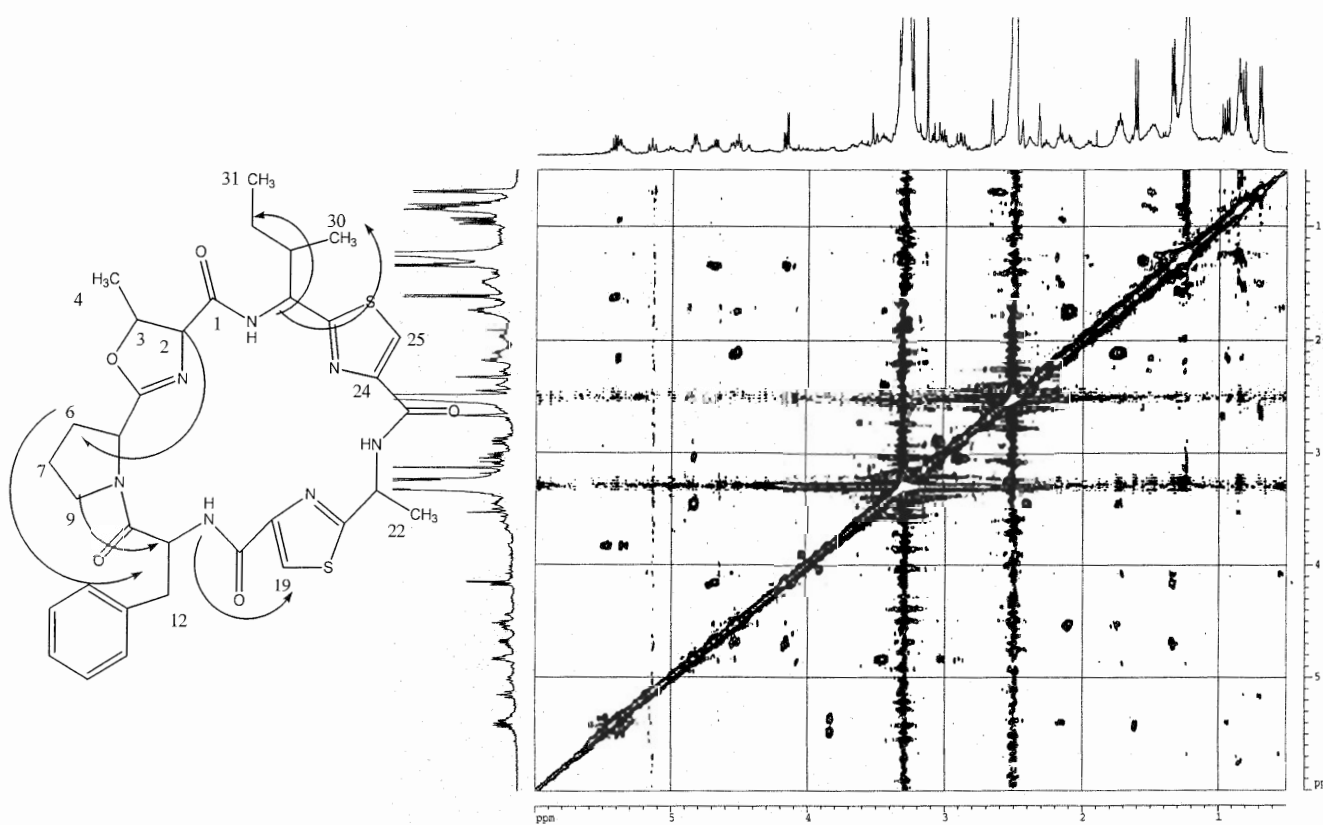

Figure 3.4.4.D: ROESY spectrum of compound 25 and 26

Results

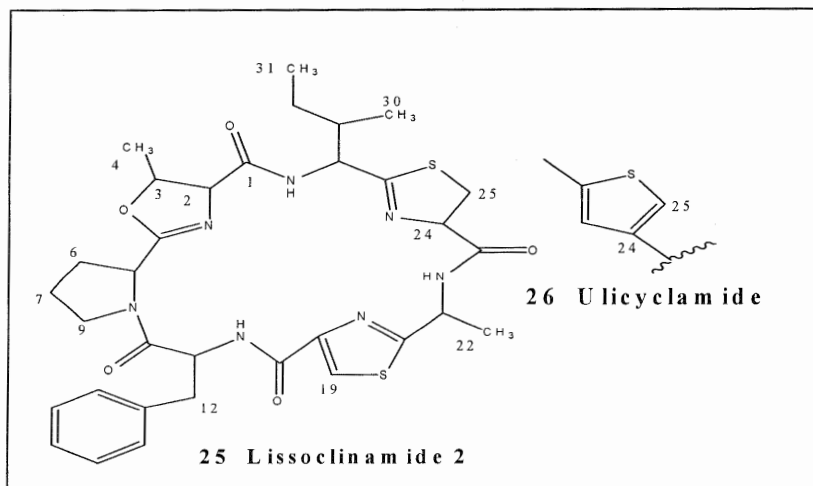

Table 3.4.2.A: NMR data in DMSO- d_6 of compound 25

H-No.	25	
	^1H NMR (ppm), multiplicity (Hz)	^1H NMR (ppm), multiplicity (Hz)*
1	-	-
2	4.21 (1H, d, $J = 3.79\text{Hz}$)	4.27
3	4.76 (1H, m)	4.81 (1H, m)
4	1.35 (3H, m)	1.51 (3H, m)
5	-	-
6	4.58 (2H, m)	4.62 (2H, m)
7A	2.21 (1H, m)	2.01 (1H, m)
7B	1.72 (1H, m)	2.34 (1H, m)
8	1.75 (2H, m)	2.01 (2H, m)
9A	3.45 (1H, m)	3.80 (1H, m)
9B	2.35 (1H, m)	2.31 (1H, m)
10	-	-
11	4.84 (1H, m)	5.14 (1H, m)
12	3.10 (2H, m)	3.17 (2H, m)
13-16	7.35 (5H, m)	7.18 (5H, m)
17	-	-
18	-	-
19	8.33 (1H, s)	8.00 (1H, s)
20	-	-
21	5.44 (1H, m)	5.33 (1H, m)
22	1.62 (3H, d, 6.71 Hz)	1.56 (3H, d, 7Hz)
23	-	-
24	5.40 (1H, dd, $J=3.04$ Hz)	5.21 (1H, dd, $J=4.6$ Hz)
25	3.60 (2H, m)	3.48, 3.42
26	-	-
27	5.16 (1H, t, $J=9.81$ Hz)	5.14 (1H, m)
28	2.65 (1H, m)	2.45 (1H, m)
29	1.48 (2H, m)	1.43 (2H, m)
30	0.97 (3H, t, 6.50 Hz)	0.93 (3H, t, 8 Hz)
31	0.81 (3H, d, 6.93 Hz)	1.02 (3H, d, 7 Hz)
NH-1	7.81 (d, $J = 9.46$ Hz)	-
NH-2	8.60 (br. s)	-
NH-3	8.90 (br. s)	-

The compound was measured in DMSO- d_6 .

*Measured by Sesin (Sesin *et al.*, 1986) in (CDCl_3)

Results

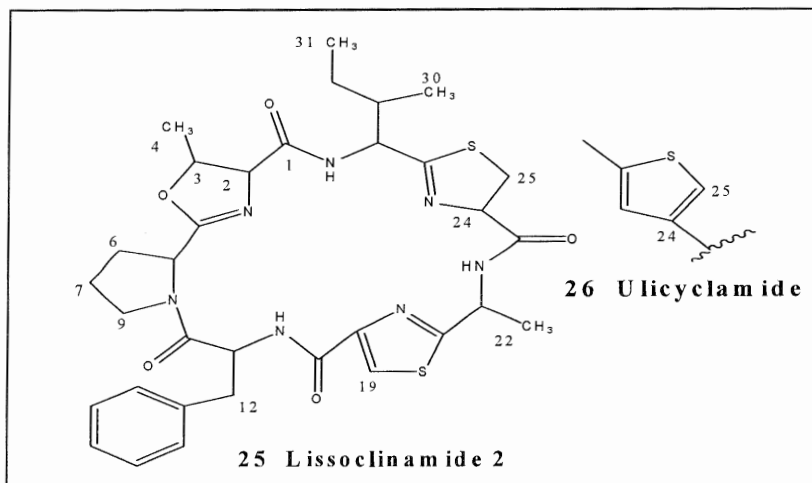

Table 3.4.2.B: NMR data in DMSO-*d*₆ of compound 26

H-No.	26	
	¹ H NMR (ppm), multiplicity (Hz)	¹ H NMR (ppm), multiplicity (Hz)*
1	-	-
2	4.17 (1H, d, <i>J</i> = 3.7Hz)	4.26 (1H, d, <i>J</i> = 4Hz)
3	4.70 (1H, dd,, <i>J</i> = 4.5, 6.3 Hz)	4.82 (1H, dd,, <i>J</i> = 4, 7 Hz)
4	1.35 (3H, m)	1.44 (3H, m)
5	-	-
6	4.52 (2H, t, <i>J</i> = 7.5 Hz)	4.52 (2H, t, <i>J</i> = 8 Hz)
7A	2.21 (1H, m)	1.9 (1H, m)
7B	1.72 (1H, m)	
8	1.75 (2H, m)	1.35 (2H, m)
9A	3.45 (1H, m)	3.25 (1H, m)
9B	2.35 (1H, m)	
10	-	-
11	4.84 (1H, m)	4.89 (1H, m)
12	2.90 (2H, m)	3.25 (2H, m)
13-16	7.35 (5H, m)	7.30 (5H, m)
17	-	-
18	-	-
19	8.36 (1H, s)	8.03 (1H, s)
20	-	-
21	5.44 (1H, m)	5.38 (1H, m)
22	1.62 (3H, d, 6.71 Hz)	1.71 (3H, d, 7 Hz)
23	-	-
24	-	-
25	8.35 (1H, s)	8.08 (1H, s)
26	-	-
27	5.04 (1H, m)	5.26 (1H, m)
28	2.65 (1H, m)	2.65 (1H, m)
29	1.48 (2H, m)	2.1 (2H, m)
30	0.94 (3H, d, 6.94 Hz)	0.85 (3H, d, 7 Hz)
31	0.71 (3H, d, 6.92 Hz)	0.73 (3H, d, 7 Hz)
NH-1	7.75 (d, <i>J</i> = 10.08 Hz)	7.85 (d, <i>J</i> = 10 Hz)
NH-2	8.50 (d, <i>J</i> = 6.93 Hz)	8.67 (d, <i>J</i> = 7 Hz)
NH-3	9.00 (d, <i>J</i> = 5.04 Hz)	9.06 (d, <i>J</i> = 5 Hz)

The compound was measured in DMSO-*d*₆.

* Measured by Sesin (Sesin *et al.*, 1986) in (CDCl₃)

3.5 β -Carboline derivatives from the marine sponge *Hyrtios reticulatus*

Marine sponges of the genus *Hyrtios* have proven to be a rich source of secondary metabolites. Until now three classes of secondary metabolites have been reported from this genus: terpenoids (mainly sesterterpenes and sesquiterpene / quinones), macrolides and tryptamine-derived alkaloids (see Figure 3.5.A).

β -Carboline was isolated from *Chrysophyllum lacourtianum*, *Nocardia sp.*, *Catharanthus roseus* leaves, *Lolium perenne*, *Strychnos johnsonii*, *Strychnos potatorum* and *Festuca arundinacea*. It was also produced by *Streptomyces sp.* and by the New Zealand ascidian *Ritterella sigillinoides* (Marine Lit., 2003).

In the current work three β -carboline derivatives have been isolated from the sponge *Hyrtios reticulatus*. β -Carbolines are a class of indole alkaloids which are structurally similar and biosynthetically derived from the amino acid L-tryptophan. Tryptophan derivatives are very important for the Central Nervous System (CNS) function. They include the neurotransmitter serotonin, the potent hallucinogen dimethyl tryptamine (DMT) and the mono amine oxidase inhibitors (MAOI) (Griebel *et al.*, 1999). Some β -carbolines were used clinically to treat depression such as harmine and harmaline (Siddiqui *et al.*, 1988) which are isolated from the plant *Peganum harmala* or (Syrian rue) (see Figure 3.5.B).

Results

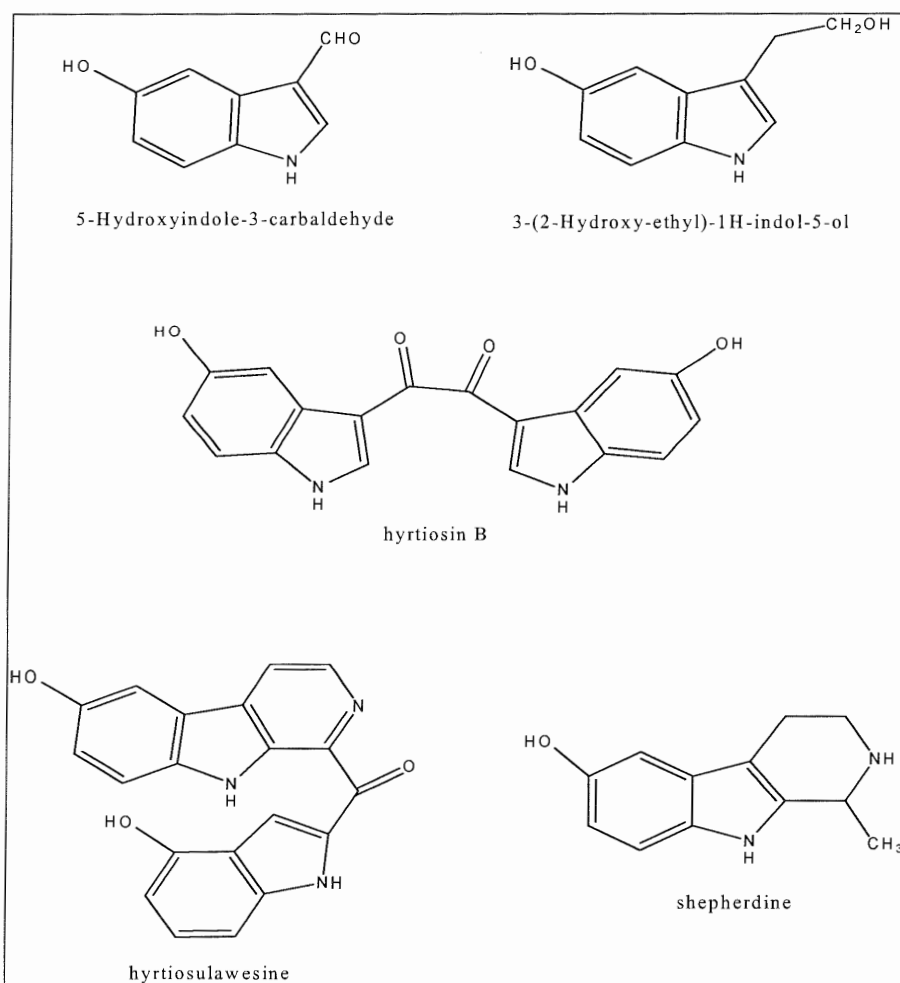

Fig. 3.5.A: Some metabolites isolated from the sponges *H. erectus* and *H. reticulatus*

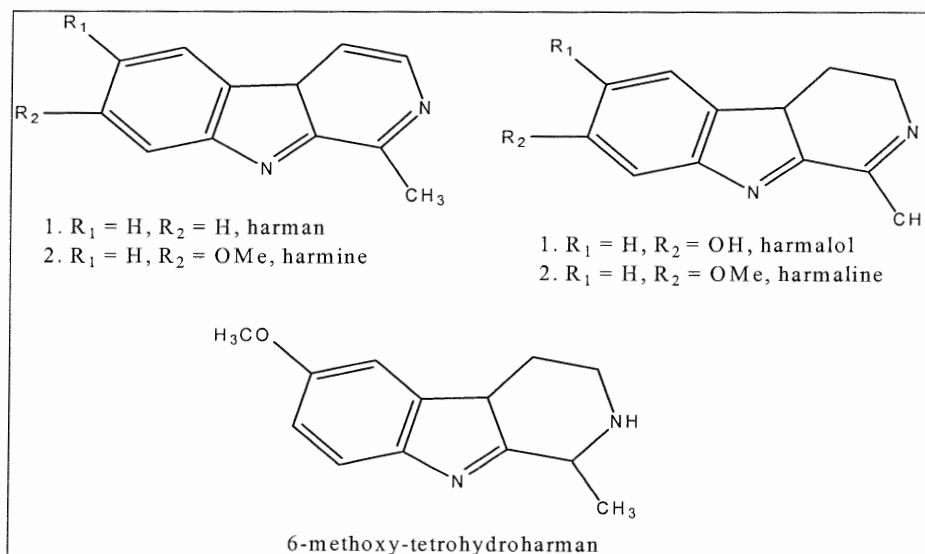

Fig. 3.5.B: Metabolites of the seeds of *Peganum harmala*

6-Hydroxy-2,9-dihydro- β -carbolin-1-one (compound 27)

Chemical name: 6-Hydroxy-2,9-dihydro- β -carbolin-1-one

Character: red- orange oil

Amount: 30 mg

Sample code: TM12 eth.si.10

Molecular weight: 200 g / mol

Biological source: marine sponge *Hyrtios reticulatus* (TM 12)

Molecular formula: C₁₁H₈N₂O₂

New natural product

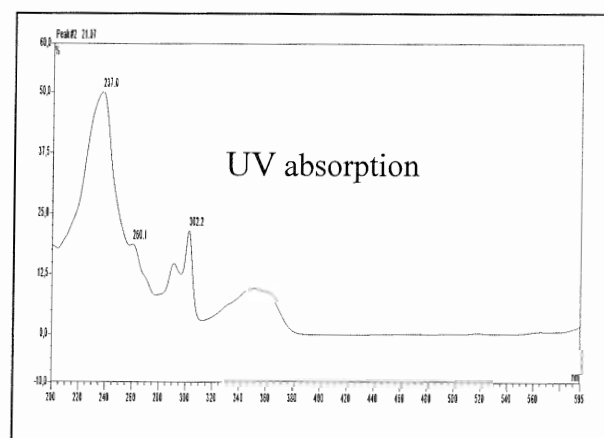
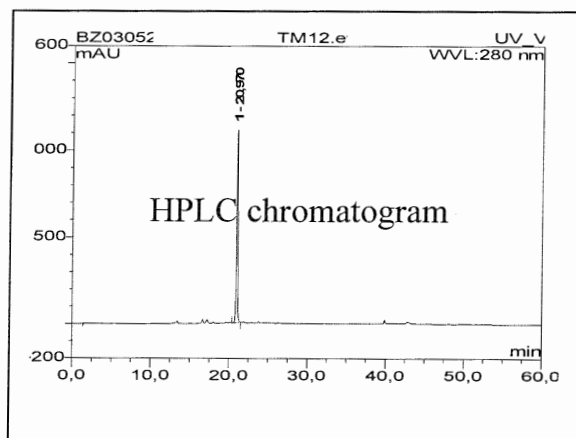
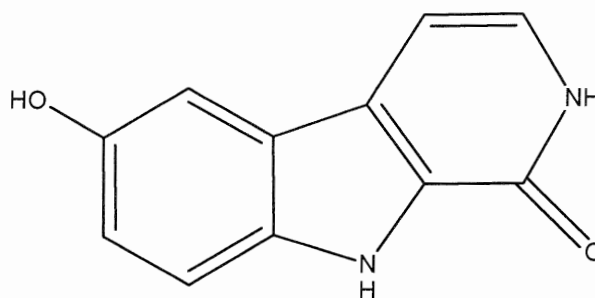

ESIMS: m/z 201 [M+H]⁺ (Positive)

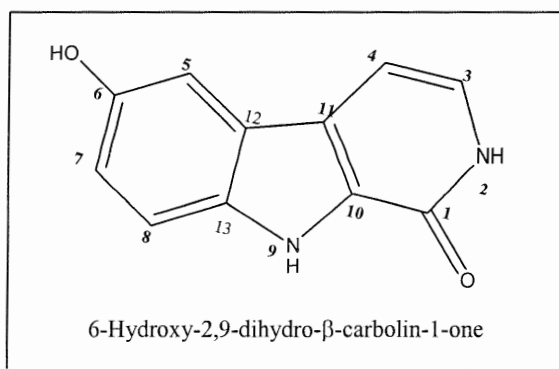
3.5.1 Structure elucidation of 6-hydroxy-2,9-dihydro- β -carbolin-1-one[27] (new)

Compound 27 is a β -carboline derivative which was isolated for the first time; similar metabolites were isolated from the genus *Hyrtios* by Salmoun (Salmoun *et al.*, 2002).

Compound [27] was isolated as a red- orange oil, UV (MeOH) absorbance was observed at λ_{max} 237, 260 and 302 nm. The positive ESIMS showed the molecular ion peak at m/z 201.4 $[M+H]^+$ (see Fig.3.5.1.A). This together with the NMR spectra suggested the molecular formula $C_{11}H_8N_2O_2$.

The 1H -NMR spectrum of compound 27 (see Figure 3.5.1.B) showed the typical coupling of a phenyl ring system. It showed the *meta* coupling proton H-5 at 7.25 ppm (1H, d), the *ortho* coupling proton H-8 at 7.30 ppm (1H, d), and the *ortho-meta* coupling proton H-7 at 6.92 ppm (1H, dd) (see Table 3.5.1.A) as well as two signals in the aromatic region at 6.85 ppm (1H, d) and 6.96 ppm (1H, t) which indicated the presence of a double bond. The ^{13}C NMR spectrum (see Figure 3.5.1.C) and HMQC spectrum (see Figure 3.5.1.D) exhibited the positions of carbonyl group at 155.7, the carbons attached to the *meta* coupling proton at 104.5, to the *ortho* coupling proton at 113.0 and to the *meta-ortho* coupling proton at 117.0 (see Table 3.5.1.A).

COSY spectrum (see Figure 3.5.1.E) showed cross peaks for correlation between the triplet (H-3) and the doublet (H-4) peaks with the NH in the pyridine ring.

Through the HMBC spectrum the structure was confirmed (see Figure 3.5.1.F), which showed a long range coupling between the proton H-3 with the carbonyl group. It also showed that the *meta* proton has a long range coupling with C-11, C13 and C7 (see Table 3.5.1.A).

Results

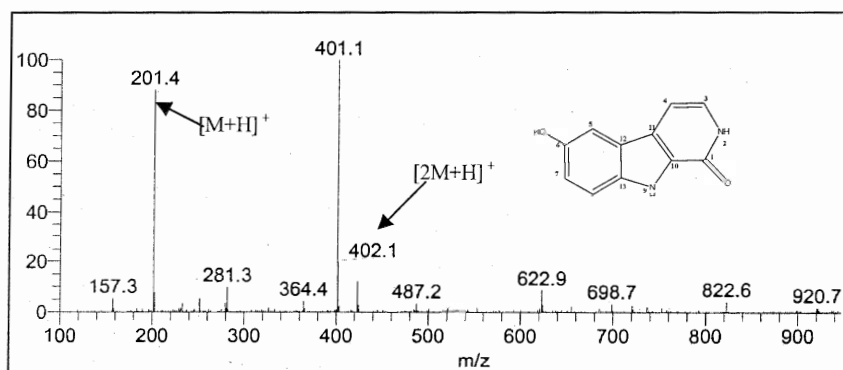

Figure 3.5.1.A: ESI⁺ mass spectrum of compound 27

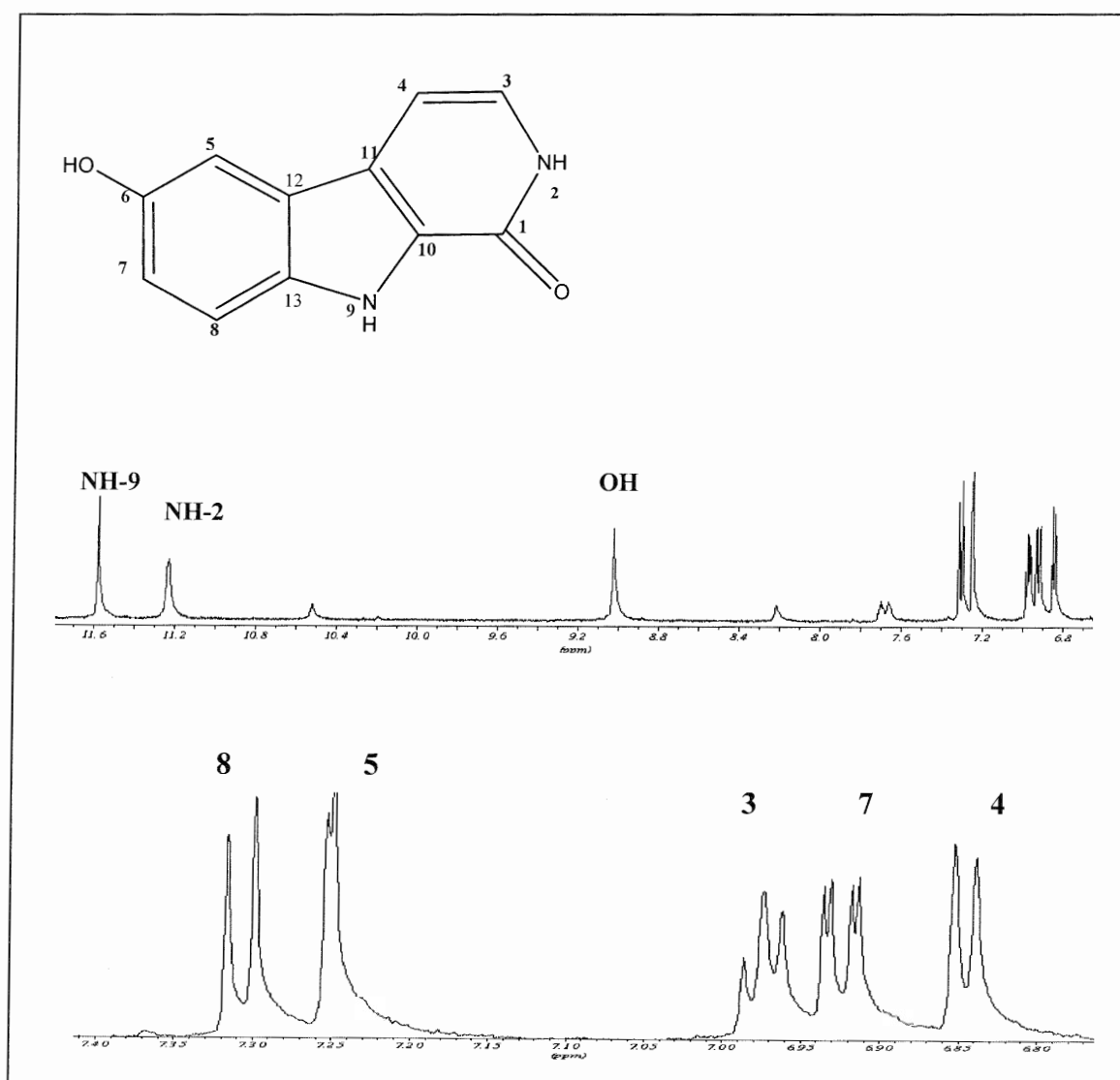

Figure 3.5.1.B: ¹H-NMR spectrum of compound 27

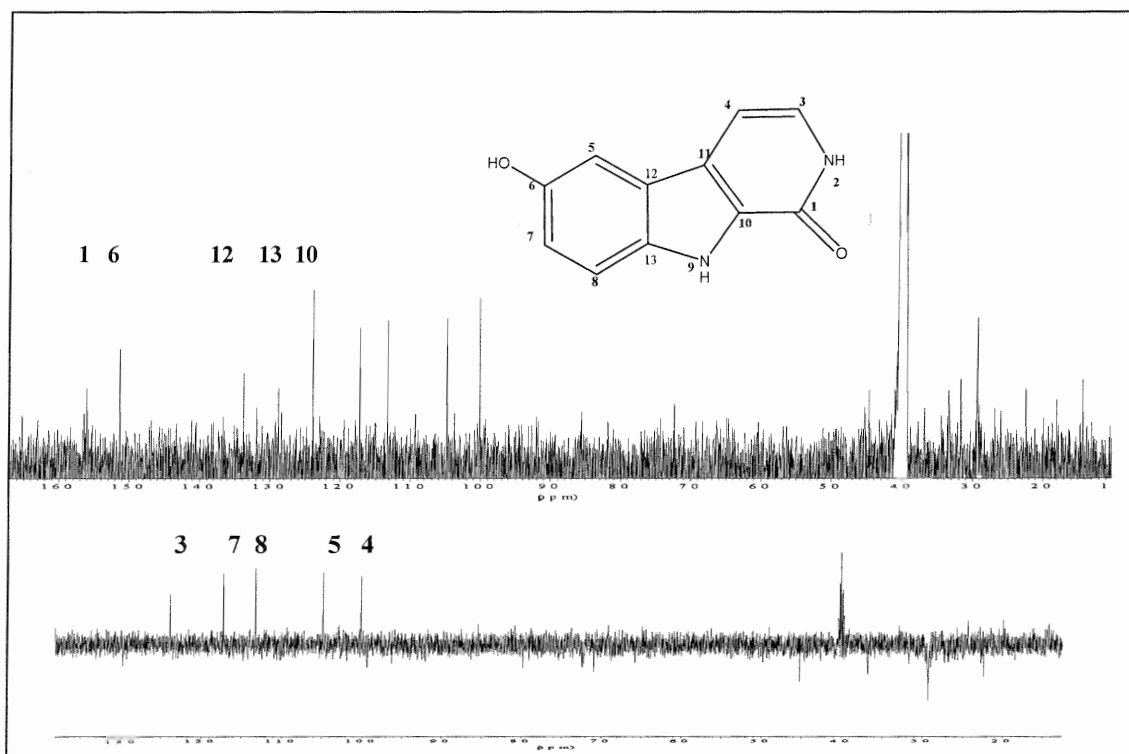

Figure 3.5.1.C: ^{13}C -NMR and DEPT spectra of compound 27

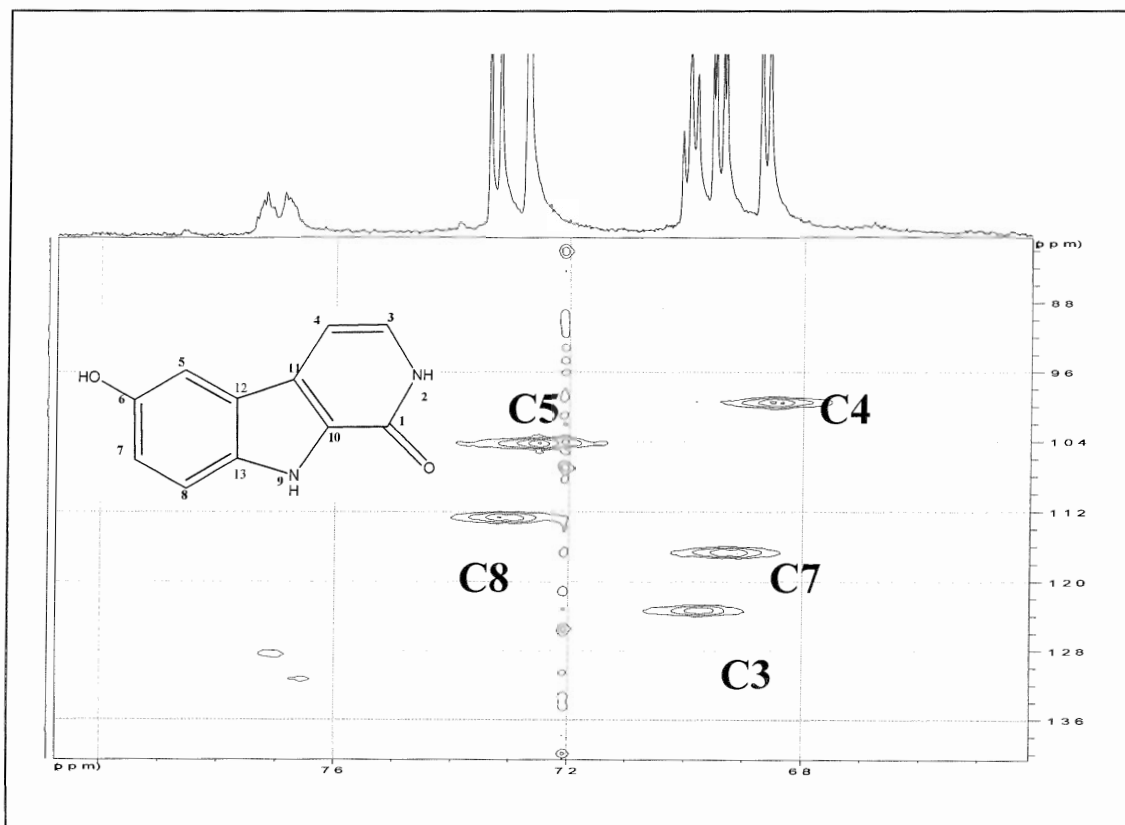

Figure 3.1.5.D: HMQC spectrum of compound 27

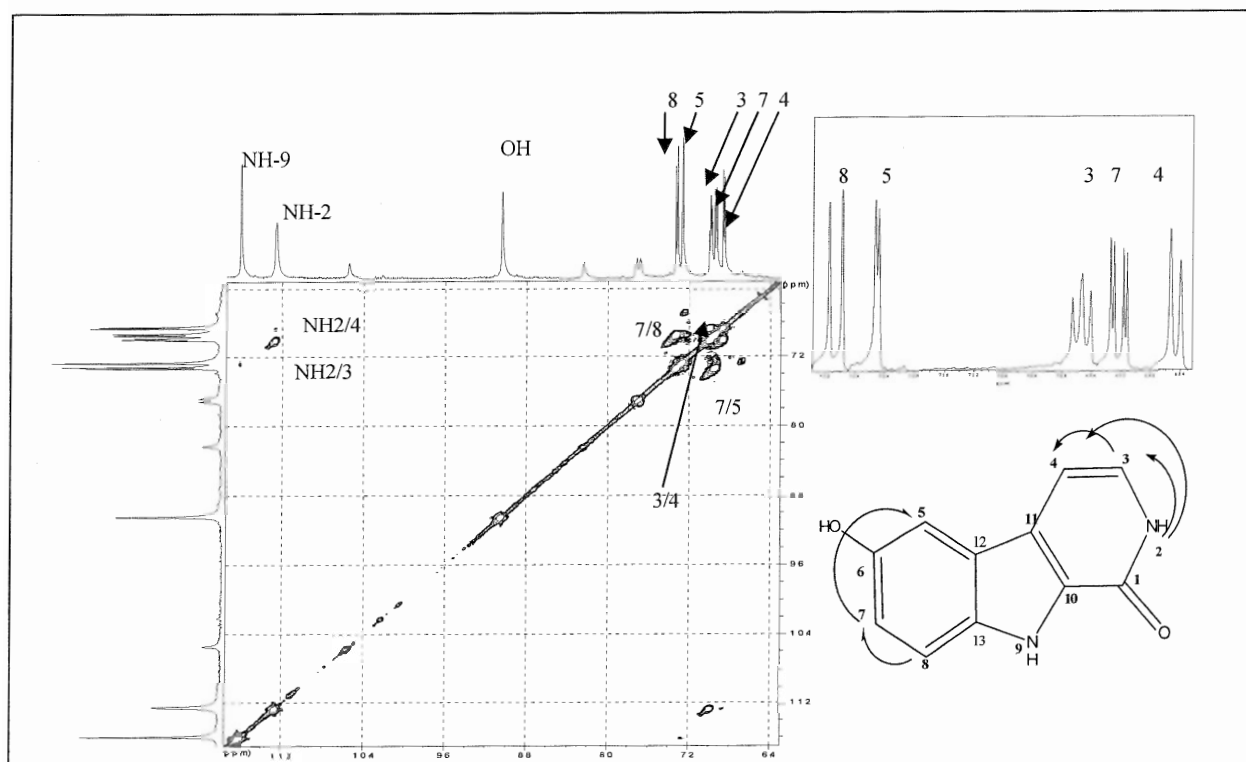
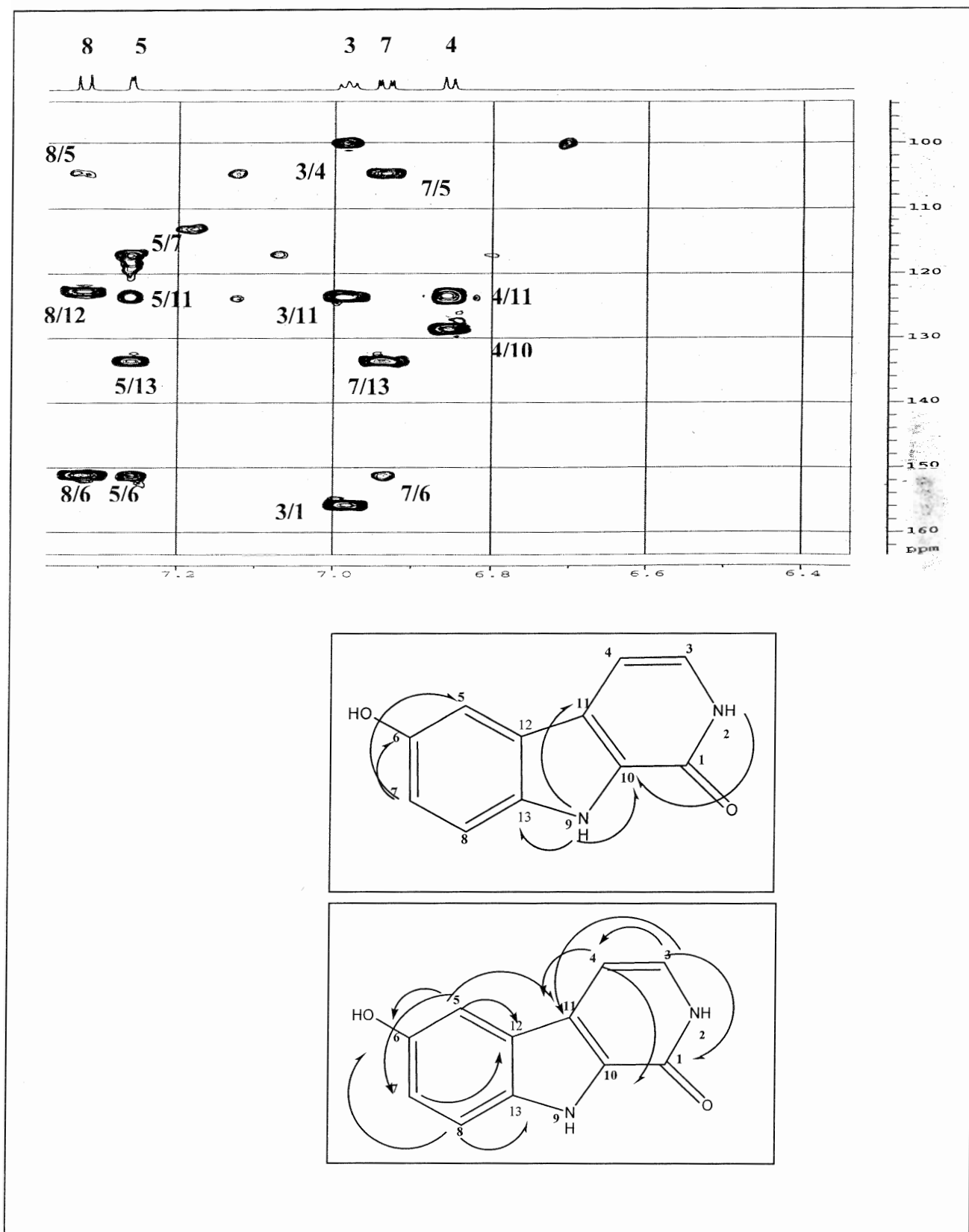

Figure 3.5.1.E: COSY spectrum of compound 27

Table 3.5.1.A: NMR data of compound 27

No.	27		
	¹ H NMR (ppm), multiplicity (Hz)	¹³ C -NMR (ppm)	HMBC H → C
1	-	155.7 s	-
3	6.96 (1H, t, <i>J</i> = 5.6 Hz)	123.2 d	1, 4, 11
4	6.85 (1H, d, <i>J</i> = 6.0 Hz)	99.4 d	10, 11
5	7.25 (1H, d, <i>J</i> = 2.2 Hz)	104.1 d	6, 7, 11, 13
6	-	150.5 s	-
7	6.88 (1H, dd, <i>J</i> = 2.5, 8.8 Hz)	116.6 d	5, 6, 13
8	7.30 (1H, d, <i>J</i> = 8.8 Hz)	112.5 d	5, 6, 13
10	-	123.9 s	-
11	-	128.9 s	-
12	-	122.8 s	-
13	-	133.7 s	-
NH-2	11.25 br.s	-	10
NH-9	11.60 br.s	-	10, 11, 13

The compound was measured in DMSO-*d*₆.



Results

6-Hydroxy-3,4-dihydro-1-oxo- β -carboline (compound 28)

Chemical name: 6-Hydroxy-3,4-dihydro-1-oxo- β -carboline

Character: red- orange oil

Amount: 8 mg

Sample code: TM12 eth.5+6-pr3

Molecular weight: 202 g / mol

Biological source: marine sponge *Hyrtios reticulatus* (TM 12)

Molecular formula: C₁₁H₁₀N₂O₂

Fist time isolated

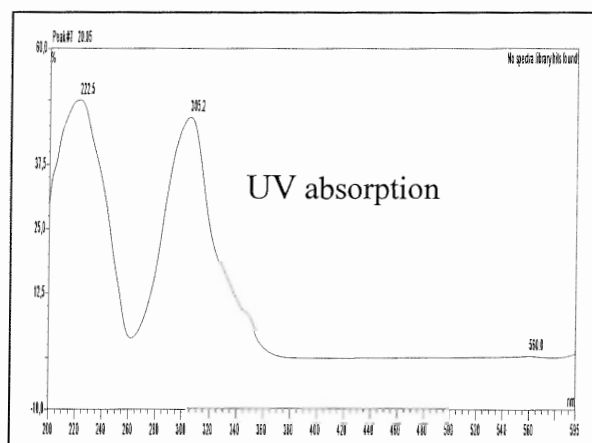
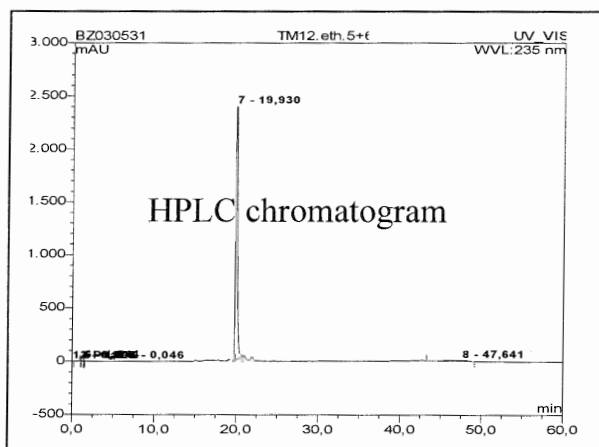
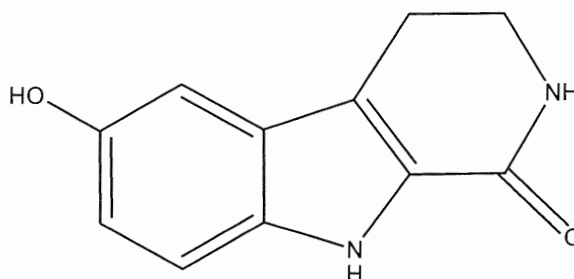

ESIMS: m/z 203 [M+H]⁺ (Positive)

HREIMS: $m/z = 202$ [M]⁺
Experimental = 202.07481
Calculated = 202.07423
for C₁₁H₁₀N₂O₂

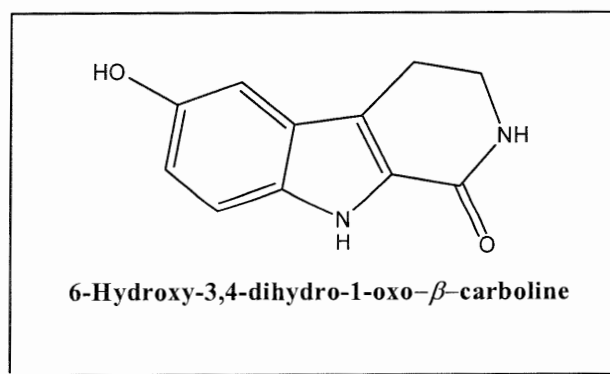
3.5.2 Structure elucidation of 6-hydroxy-3,4-dihydro-1-oxo- β -carboline [28].

Compound 28 was isolated for the first time in this form; it was previously reported as a natural product that was isolated after acetylation form (Salmoun *et al.*, 2002).

Compound [28] was isolated as red- orange oil, UV (MeOH) absorbances were at λ_{max} 222 and 305 nm. The positive ESIMS (see Figure 3.5.2.A) showed the molecular ion peak at m/z 203.3 $[M+H]^+$. This together with the NMR spectra suggested the molecular formula $C_{11}H_{10}N_2O_2$.

The 1H -NMR spectrum of compound **28** (see Figure 3.5.2.B) showed the typical coupling of the phenyl ring system, previously discussed for compound **27**, with a *meta* coupling proton H-5 at 6.83 ppm (1H, d), an *ortho* coupling proton H-8 at 7.19 ppm (1H, d) and a *ortho-meta* coupling proton H-7 at 6.75 ppm (1H, dd) (see Table 3.5.2.A). In addition, it showed the absence of the two signals in the aromatic region that were present in compound **27** and the presence of two signals in the aliphatic region with integration of two protons each at 2.85 ppm (2H, t) and 3.45 ppm (2H, dt). Moreover, two broad singlet signals of the two NH from the indole and the piperidine rings were observed at 11.31 ppm and at 7.45 ppm, respectively and the hydroxyl group was found at 8.85 ppm (see Table 3.5.1.A).

The ^{13}C -NMR spectrum (see Figure 3.5.2.C) showed the carbonyl group at 155.7, two methylenes at 20.7 and 41.5 and the carbons of the phenyl ring at 103.3, 113.3 and 115.3 ppm and the carbon bearing to the hydroxyl group at 151.2 (see Table 3.5.1.A).

The COSY spectrum (see Figure 3.5.2.D) indicated a cross peak for correlation between the NH in the piperidine ring with the methylene group H-3, as well as a cross peak for correlation of the two methylene groups with each other.

The structure was confirmed by the HMBC spectrum showing a correlation of the methylene groups with the carbonyl group, NH-9 of the pyrrole ring with C-9, 10, 11 and 12, NH-2 in the piperidine ring with C-10 and H-5, H-7 and H-8 of the phenyl ring with C-6 and C-13 (see Figure 3.5.2.E and Table 3.5.1.A).

Results

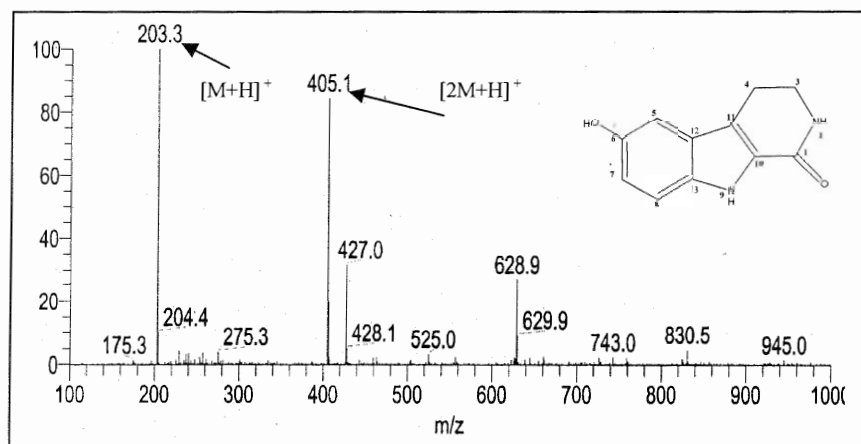

Figure 3.5.2.A: ESI⁺ mass spectrum of compound 28

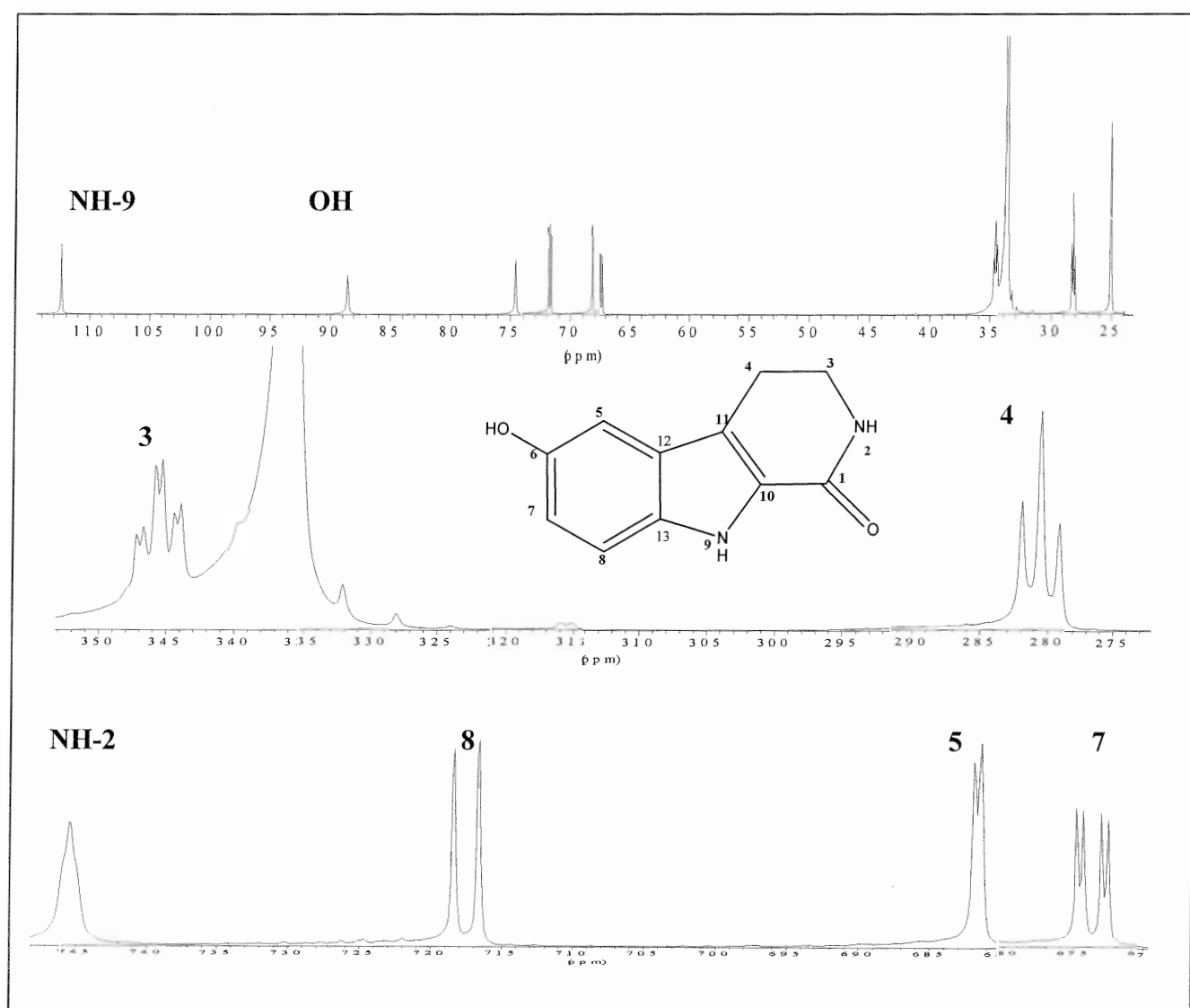

Figure 3.5.2.B: ¹H-NMR spectrum of compound 28

Results

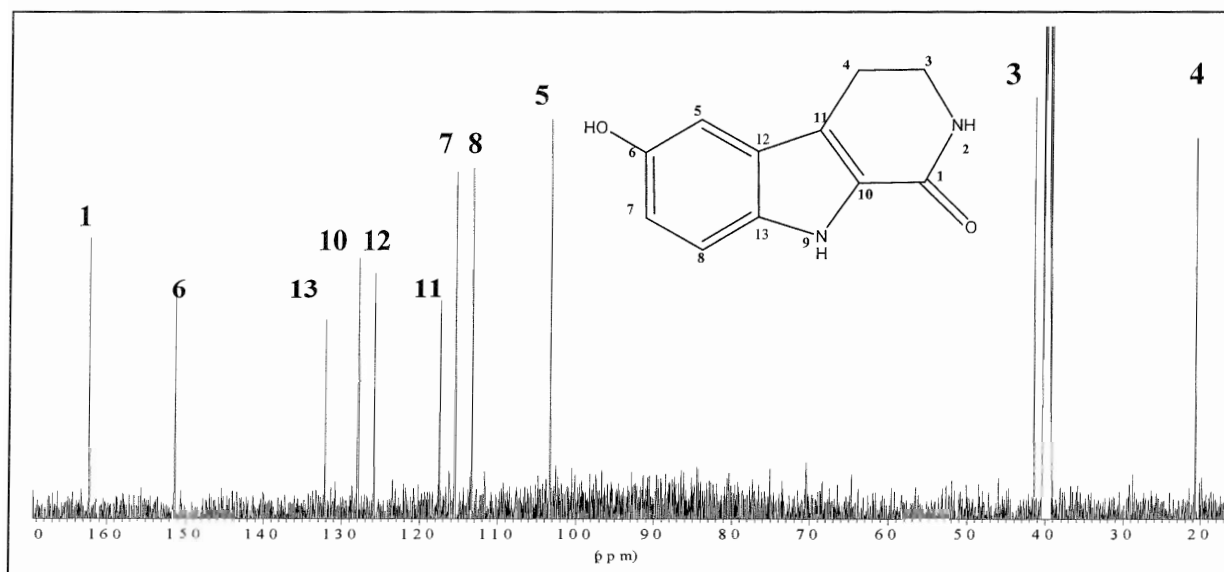

Figure 3.5.2.C: ^{13}C -NMR spectrum of compound 28

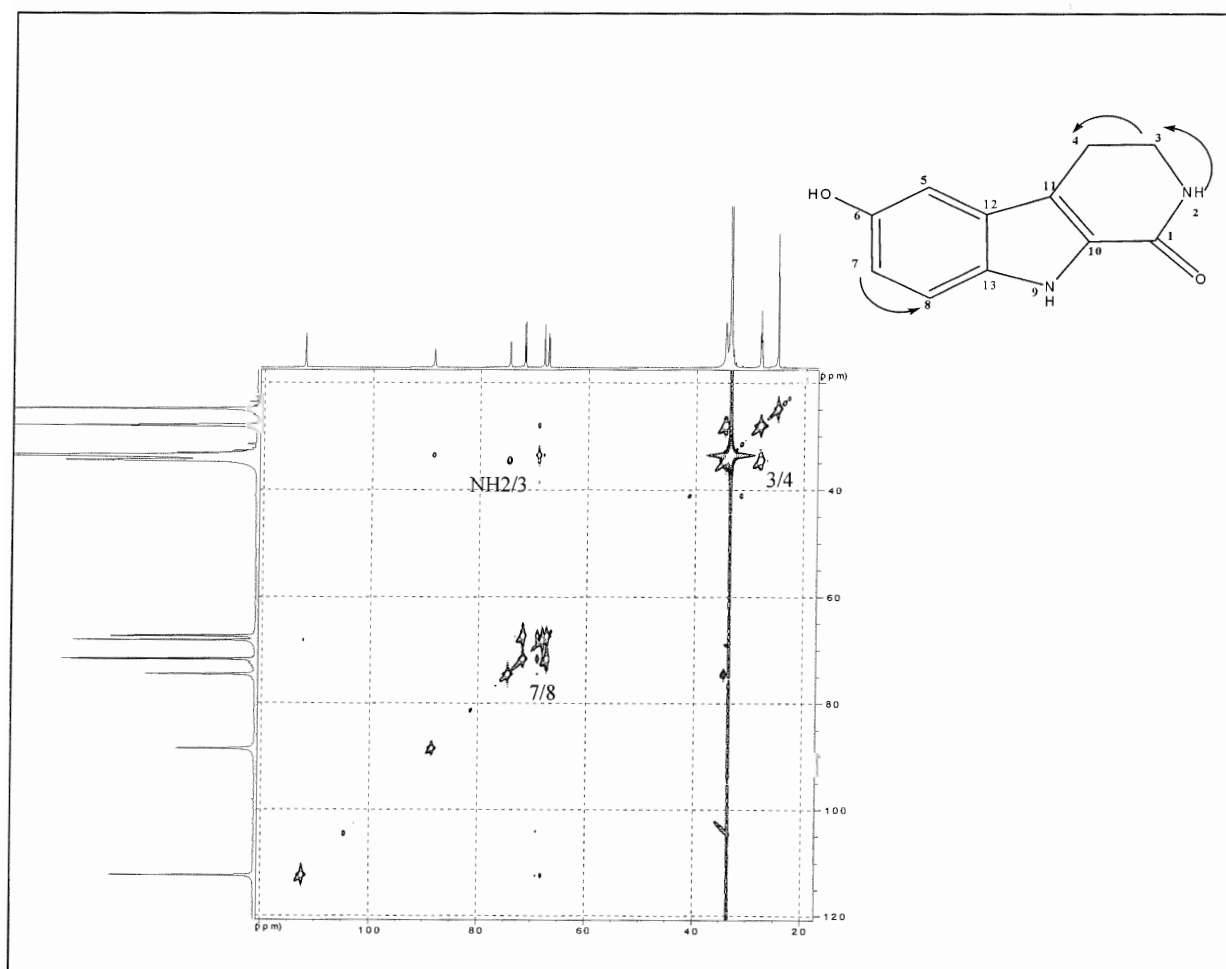

Figure 3.5.2.D: COSY spectrum of compound 28

Results

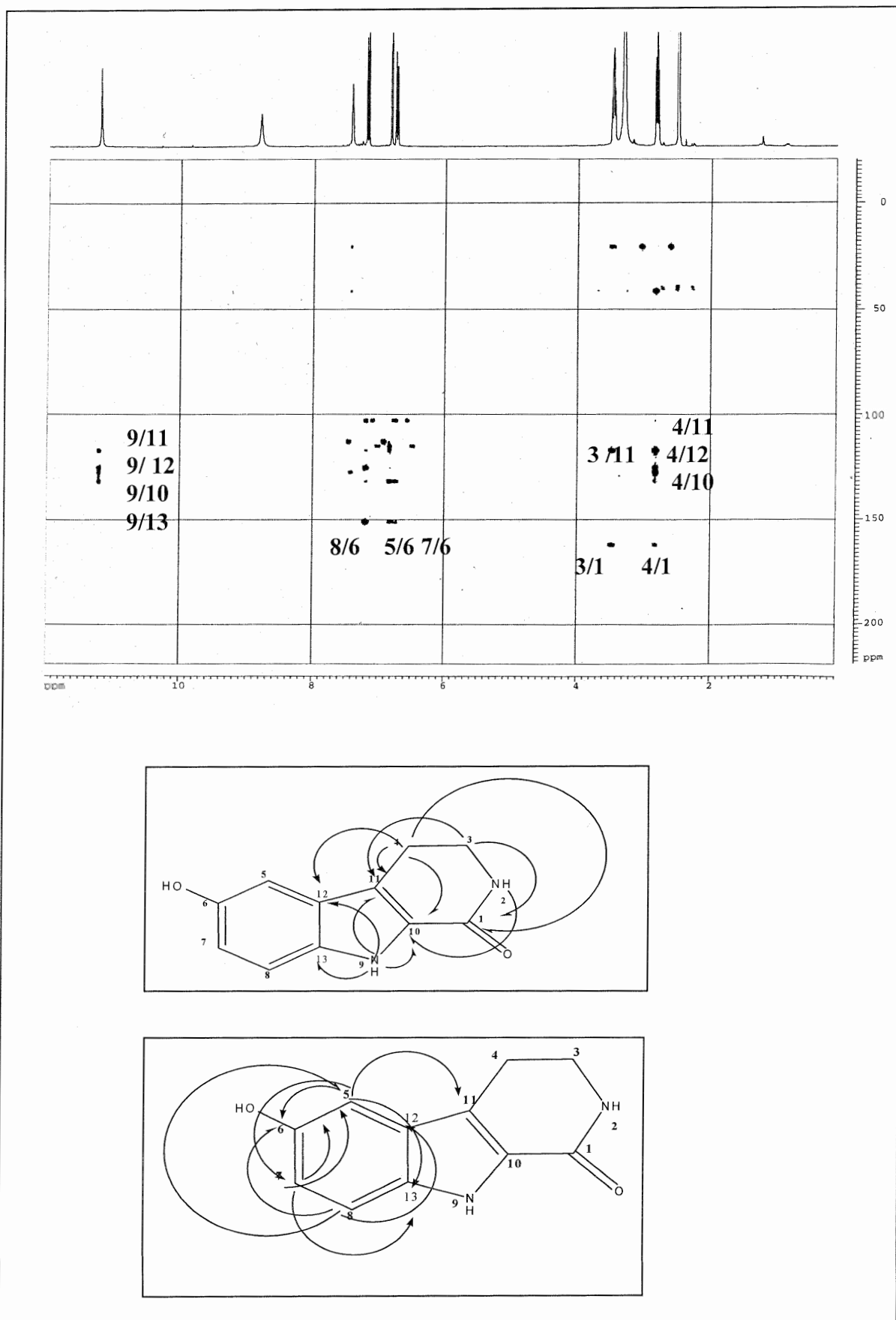

Fig. 3.5.2.E: HMBC spectrum of compound 28

Results

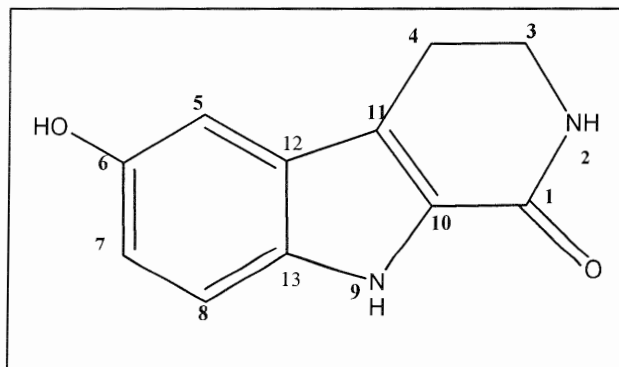
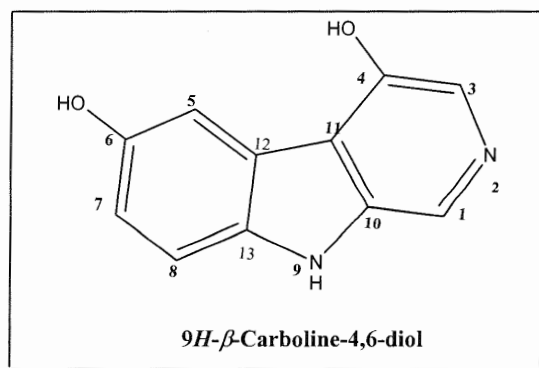

Table 3.5.2.A: NMR data of compound 28

No.	28		
	¹ H NMR (ppm), multiplicity (Hz)	¹³ C -NMR (ppm)	HMBC H → C
1	-	162.2 s	-
3	2.85 (2H, t, <i>J</i> = 2.2 Hz)	41.5 t	1, 11
4	3.45 (2H, ddd, <i>J</i> = 2.2 Hz)	20.7 t	1,10, 11,12
5	6.83 (1H, d, <i>J</i> = 2.2 Hz)	103.3 d	6, 7, 11, 13
6	-	151.2 s	-
7	6.75 (1H, dd, <i>J</i> = 2.2, 8.83 Hz)	115.4 d	5, 6, 13
8	7.19 (1H, d, <i>J</i> = 8.8 Hz)	113.3 d	5, 6, 12
10	-	127.8 s	-
11	-	117.9 s	-
12	-	125.8 s	-
13	-	132.1 s	-
NH-2	7.45 br.s	-	10
NH-9	11.30 br.s	-	10, 11, 12,13

The compound was measured in DMSO-*d*₆.

3.5.3 Structure elucidation of 9H- β -carboline-4,6-diol [29] (new).

Compound 29 is a β -carboline derivative which was isolated for the first time from a natural source. A similar compound, picrasidine P, was isolated from the plant *Picrasma quassioides* (Ohmoto *et al.*, 1985).

Compound [29] was isolated as a red- orange oil, UV (MeOH) absorbances were at λ_{max} 232, 258, 266 and 320 nm. The positive ESIMS (see Fig.3.5.2.A) showed the molecular ion peak at m/z 201.2 $[M+H]^+$. This together with the NMR spectra suggested the molecular formula $C_{11}H_8N_2O_2$.

The 1H -NMR spectrum (see Fig. 3.5.3.B) showed the typical coupling of the phenyl ring system. It showed a *meta* coupling proton H-5 at 7.21 ppm (1H, d), an *ortho* coupling proton H-8 at 7.17 ppm (1H, d) and an *ortho-meta* coupling proton H-7 at 6.77 ppm (1H, dd) (see Table 3.5.3.A). It also showed two signals in the aromatic region at 6.73 ppm (1H, d) and 7.30 ppm (1H, d), as well as three broad singlets corresponding to the NH of the indole ring at 11.10 ppm and the two hydroxyl groups at 8.1 and 12.15 ppm (see table 3.5.A).

The hydroxyl group attached to the phenyl group at C-6 is very common in the β -carboline derivatives, but the hydroxyl group attached to the C-4 in the pyridine ring is not so common. The second hydroxyl group in this compound should be attached to C-4 according to the coupling observed between H-3 and H-1 (see Table 3.5.3.A).

The ^{13}C -NMR and HMQC spectra (see Figure 3.5.1.C) exhibited the positions of the carbons attached to the *meta* coupling proton at 107.2 ppm, also the *ortho* coupling proton at 116.5 ppm and to the *meta-ortho* coupling proton at 114.6 ppm. It also showed the carbons C-1 and C-4 at 101.5 and 125.7 ppm, respectively (see Table 3.5.3.A).

The COSY spectrum (see Figure 3.5.3.C) indicated a cross peak for correlation between the two methine groups and cross peaks for correlation between the protons in the phenyl ring.

Results

The structure was confirmed through the HMBC spectrum (long range correlation) (see Figure 3.5.3.E), which showed a correlation of H-3 with C-11 and also H-8 with C-6 and C-12 (see Table 3.5.1.A)

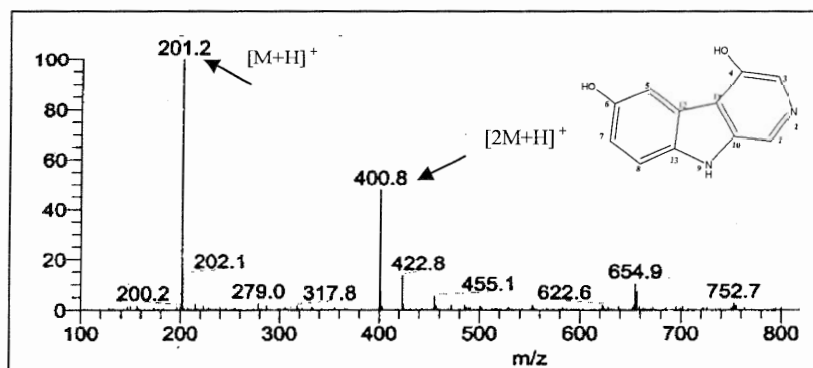

Fig. 3.5.3.A: ESI⁺ mass spectrum of compound 29

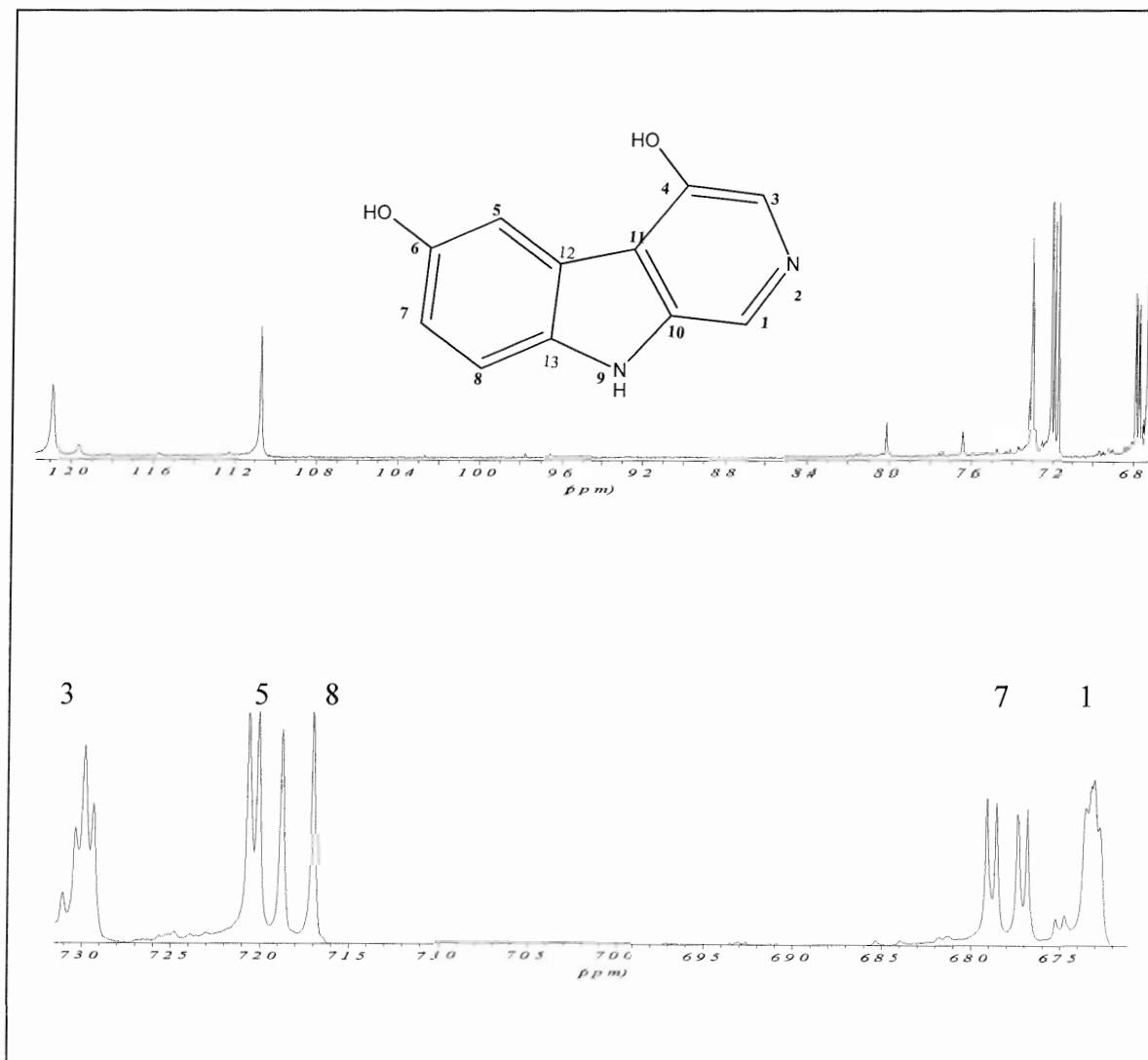

Fig. 3.5.3.B: ¹H-NMR spectrum of compound 29

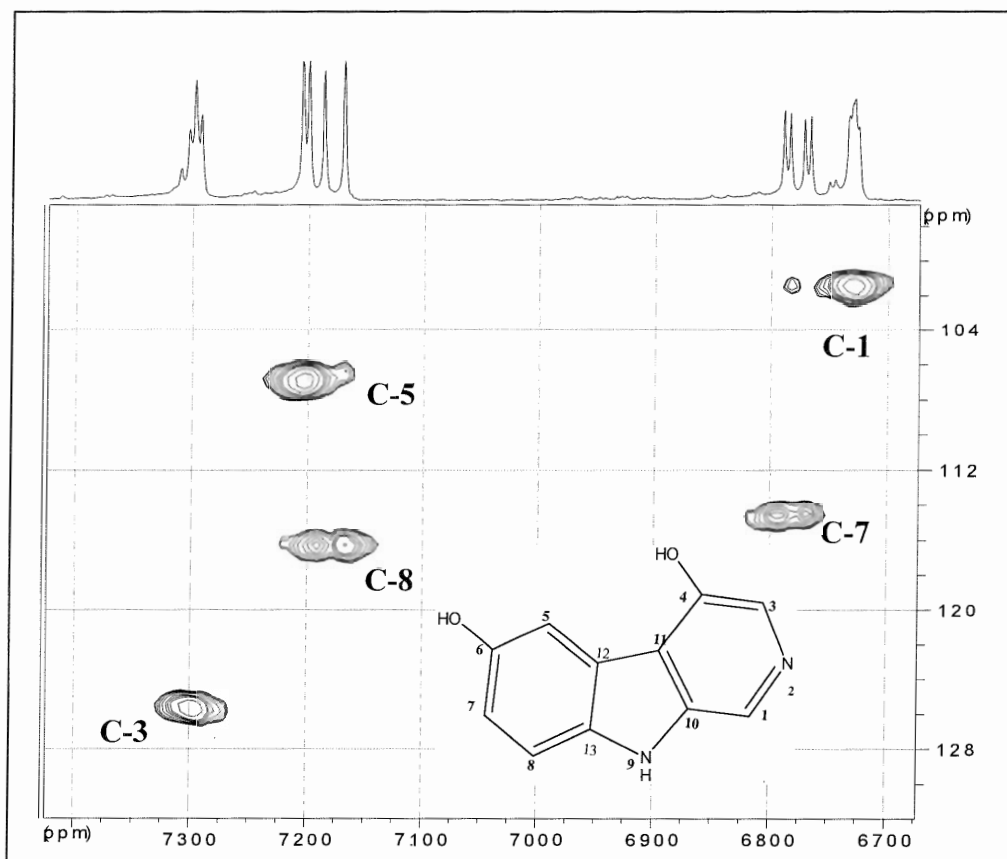

Fig. 3.5.3.C: HMOC spectrum of compound 29

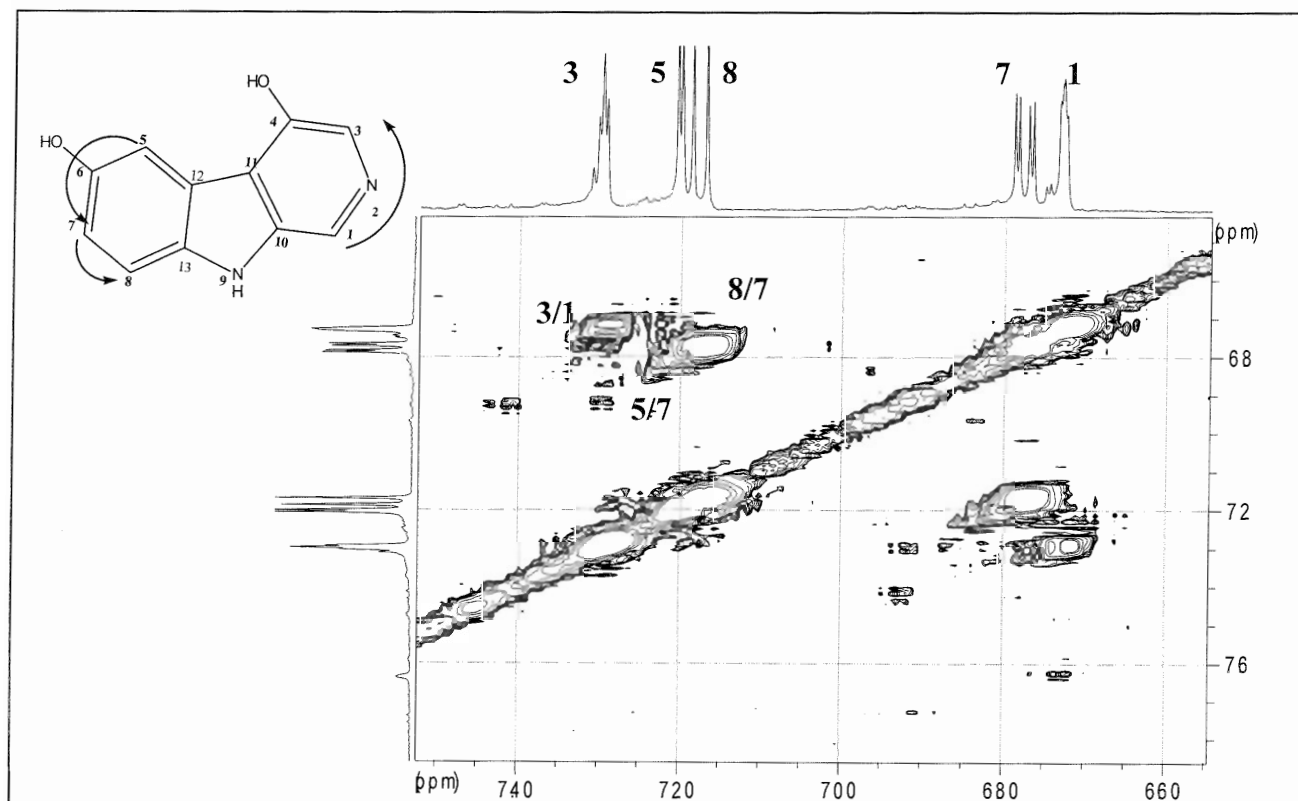

Fig. 3.5.3.D: COSY spectrum of compound 29

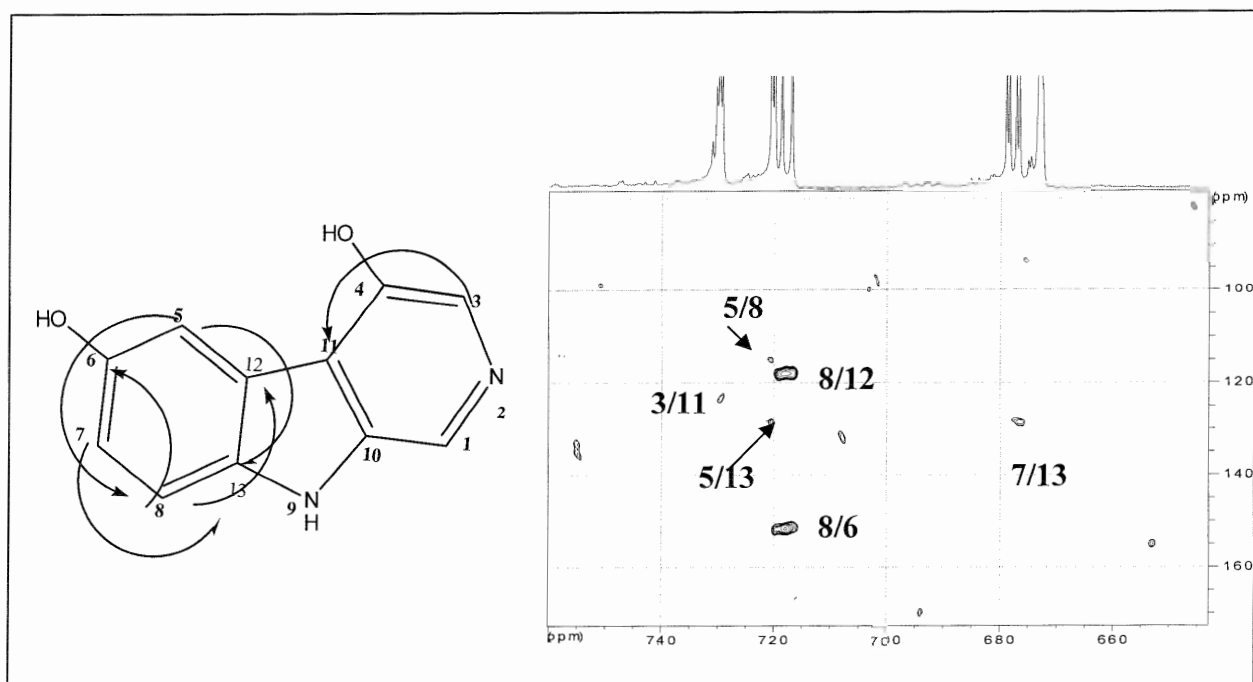

Fig. 3.5.3.E: HMBC spectrum of compound 29

Table 3.5.3.A: NMR data of compound 29

No	29		
	¹ H NMR (ppm), multiplicity (Hz)	¹³ C -NMR (ppm)	HMBC H → C
1	6.72 (1H, d, $J = 3.0$ Hz)	101.5 d	-
3	7.32 (1H, d, $J = 3.0$ Hz)	125.7 d	11
4	-	-	-
5	7.21 (1H, d, $J = 2.5$ Hz)	107.2 d	8, 13
6	-	151.6 s	-
7	6.77 (1H, dd, $J = 2.2,$ 9.0 Hz)	114.6 d	13
8	7.17 (1H, d, $J = 8.8$ Hz)	116.5 d	6, 12
10	-	-	-
11	-	123.5 s	-
12	-	118.0 s	-
13	-	128.8 s	-

The compound was measured in DMSO- d_6 .

3.5.4 Cytotoxicity test

Some of the isolated alkaloids from the sponge *Hyrtilos reticulatus* were screened for cytotoxicity towards the cell line L518y-8000/ml. The incubation of cells was for 72 hrs with the compounds (see Table 3.5.4).

Table: 3.5.4: cytotoxic activity of β -carboline alkaloids derivatives

Compound	Growth inhibition of L5178Y in % (10 μ g/ml)
6-hydroxy-2,9-dihydro- β -carbolin-1-one	41
6-hydroxy-3,4-dihydro-1-oxo- β -carboline	20

4. Discussion

Well over 14,000 different natural products have been isolated from marine organisms, hundreds of patents describing new bioactive marine natural products have been filed and approximately 10-15 different marine natural products are currently in clinical trials mostly in the areas of cancer, pain or inflammatory diseases (Proksch *et al.*, 2003).

From the marine sponges and tunicates that were collected from the Red Sea (Jordan) and from Indonesia diverse classes of compounds (bromopyrrole, imidazole, purine and β -carboline alkaloids) and cyclic peptides were isolated. The phylum *Proifera* represents a rich source for the discovery of natural biologically active compounds, for example alkaloids showing high activities in many diverse biological test system such as antitumor, anthelmintic and antimicrobial tests (Eila *et al.*, 2002 and Alejandro *et al.*, 1998) (see Table 4.A).

Table 4.A: Antitumor, anthelmintic and antimicrobial marine alkaloids
(Eila *et al.*, 2002 and Alejandro *et al.*, 1998)

Alkaloids	Effect
Agelastatin	antitumor
Haliclonacyclamin	antitumor
Naamidine A	antitumor
Ecteinascidin	antitumor
Haminol A	antimicrobial
Haminol B	antimicrobial
Indolequinones	antimicrobial
Oroidin	antiplasmodial
Chondriamide	anthelmintic

4.1 Bromopyrrole alkaloids from marine sponges

Halogenated metabolites, originally thought to be infrequent in nature, are actually not unusual at all. They are produced by many organisms, including bacteria. Whereas marine bacteria usually produce brominated compounds, terrestrial bacteria preferentially synthesize chlorometabolites, nevertheless fluoro- and iodometabolites can also be found. Haloperoxidase enzymes capable of catalyzing the formation of carbon halogen bonds in the presence of hydrogen peroxide and halide ions (Cl, Br and I) were isolated and characterized from different bacteria (Van Pée, 1996). These enzymes turned out to be unspecific and are obviously not the type of halogenating enzymes responsible for the formation of halometabolites in bacteria. A yet-unknown type of halogenating enzyme having both substrate and regio-specificity must be involved in the biosynthesis of halogenated compounds (Van Pée, 1996).

Bromopyrrole alkaloids are typical secondary metabolites of sponges from the families Agelasidae, Axinellidae and Hymeniacidonidae. Many of these compounds showed promising biological activities; they were for example found to be cytotoxic and showed α -adrenoceptor and protein kinase inhibiting activity (Eder *et al.*, 1999).

4.1.1 Bromopyrrole alkaloids from the sponge *Stylissa carteri*

From *Stylissa carteri* from the Red Sea seven brominated pyrrole alkaloids and four debrominated pyrrole alkaloids were isolated. The most active compounds were compound [5] (*Z*-hymenialdisin) and compound [4] (*Z*-debromohymenialdisin). These natural products contain a fused pyrrole [2,3-*c*] azepin-8-one ring system with either 2-aminoimidazole or glycocyamidine appendage (Xu *et al.*, 1996).

The conversion from *E* to **Z debromohymenialdisin** was explained by (Eder *et al.*, 1999); the smooth conversion of *E*-debromohymenialdisin into the respective *Z*-debromohymenialdisin isomer [4] by *E/Z* isomerization of a C-C double bond was explained by the push-pull character of the two substituents at this double bond, the entire imidazolone heterocycle on one side and the electron-rich pyrrole substituent on the other. This is best expressed by zwitterionic mesomeric structure (see Figure 4.1.1).

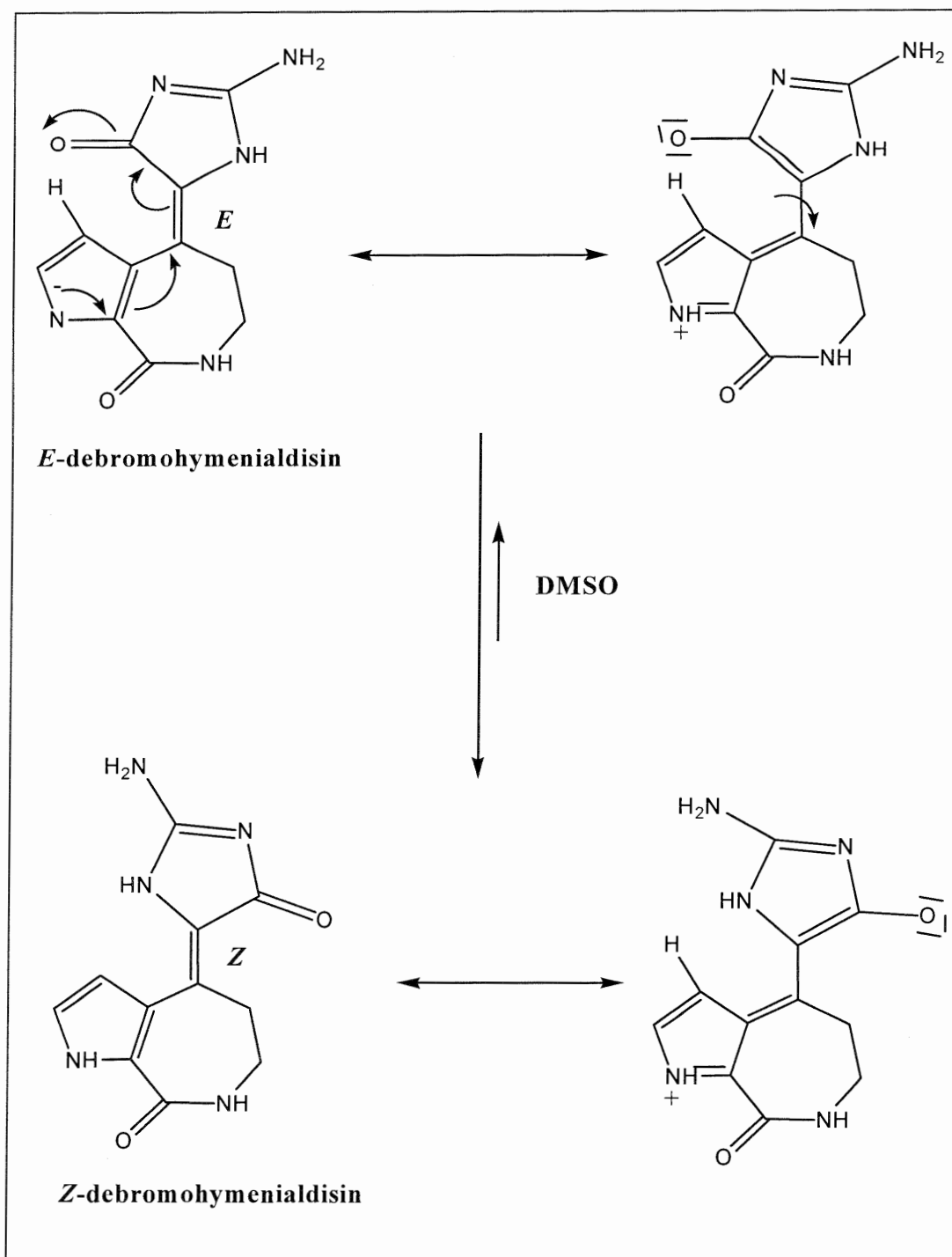

Figure 4.1.1: Mechanism for the transformation of the geometrical isomers (Eder *et al.*, 1999).

4.2 Imidazole alkaloids from marine sponges

Certain marine sponge metabolites possess a cyclic guanidine subunit that shows an interesting pharmacological activity; this cyclic guanidine moiety was found in 2-aminoimidazole which may or may not be joined to other heterocycles (Angeliki *et al.*, 1991). In case of imidazole alkaloids, the imidazole ring will be linked to a tryptophan amino acid (see biosynthesis of tryptophan Figure 4.2). Imidazole alkaloids were isolated from different marine animals for example *Verongia spengelli* and *Thorecta sp.*, anthozoans as *Astroids calycularis*, *Aplysinopsis reticulata* and *Dercitus sp.*, the nudibranch *Phestilla melanobranchia*, the coral *Tubastrea coccinea*, and also from the marine sponge *Smenospongia aurea* (Marine Lit., 2000).

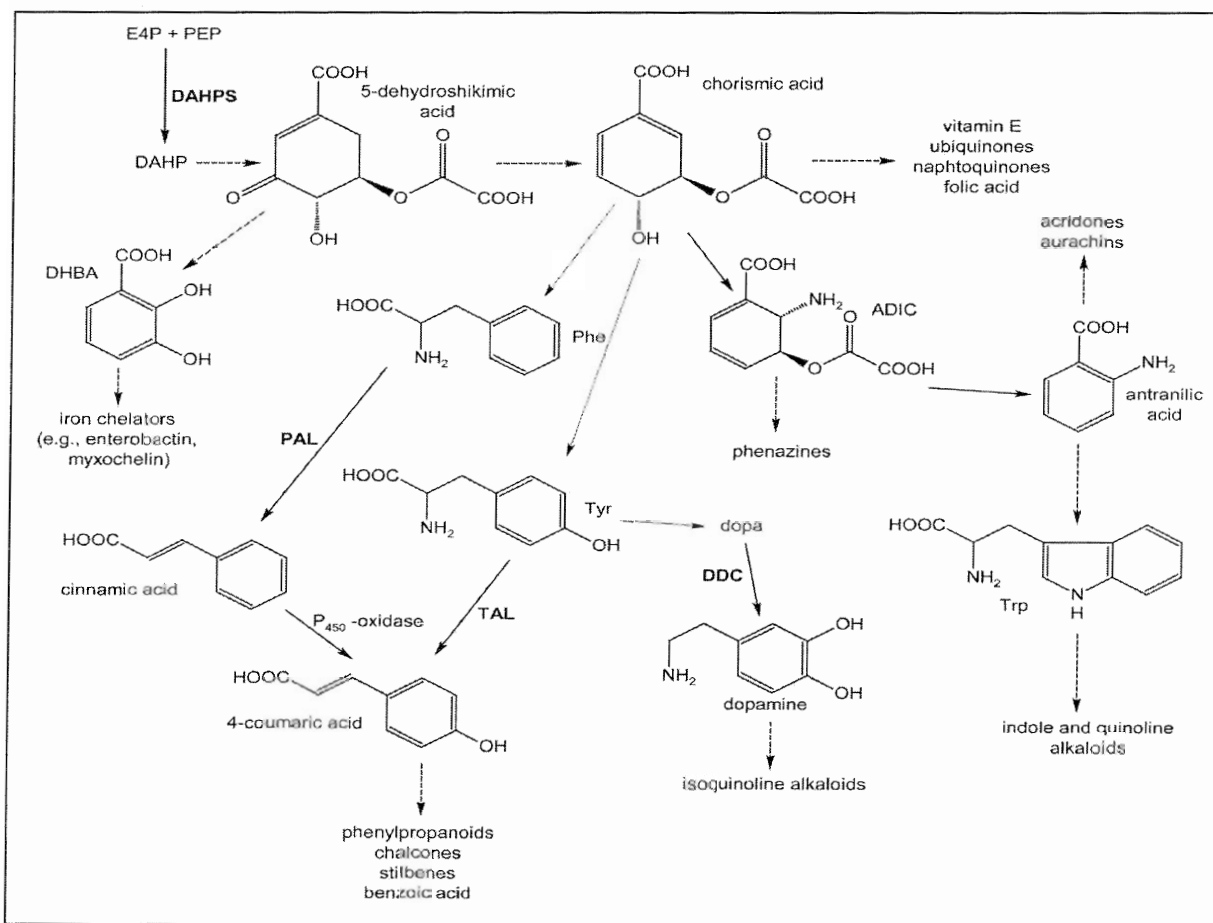

Figure 4.2: Biosynthesis of tryptophan and quinoline alkaloids (Bode *et al.*, 2003)

Broken arrows indicate multistep reactions.

DAHPS, 3-deoxyarabinoheptulosonate-7-phosphate.

DHBA, 2,3-dihydroxybenzoic acid

PAL, phenylalanine ammonia-lyase

TAL, tyrosine ammonia-lyase

ADIC, 2-amino-2-desoxy-isochorismate.

DAHPS, DAHP synthase.

E4P, erythrose-4-phosphate.

PEP, phosphoenolpyruvate.

4.2.1 Imidazole alkaloids from the sponge *Fascaplysinopsis reticulata*

Aplysinopsin [17] and the brominated aplysinopsin [19] showed high cytotoxic activities against mouse lymphoma (L5178Y) and human cervix carcinoma (HELA) cell lines (see Table 4.2.1). A synthetic analogue of aplysinopsin (CDRI compound 92/138) (see Figure 4.2.1) was reported to have antifilarial activity and was evaluated in experimental filarial infections, *Litomosoides carinii* in cotton rats (*Sigmodon hispidus*) and *Acanthocheilonema viteae* in *Mastomys coucha*. The compound killed 63.8 and 90% of adult *L. carinii* and *A. viteae* at doses of 30 and 50 mg/kg (i.p.), respectively, given for 5 days. By the oral route, at a dose of 100 mg/kg for 5 days, the compound caused 50.9 and 57% mortality of adult *L. carinii* and *A. viteae*, respectively. The compound was active *in vitro* at a concentration of 100 µg/mL, causing a significant decline in MTT reduction and ¹⁴C glucose uptake by adult filariids. Thus, synthetic marine aplysinopsin could provide a new pharmacophore for the development of antifilarial agents (Singh *et al.*, 1997).

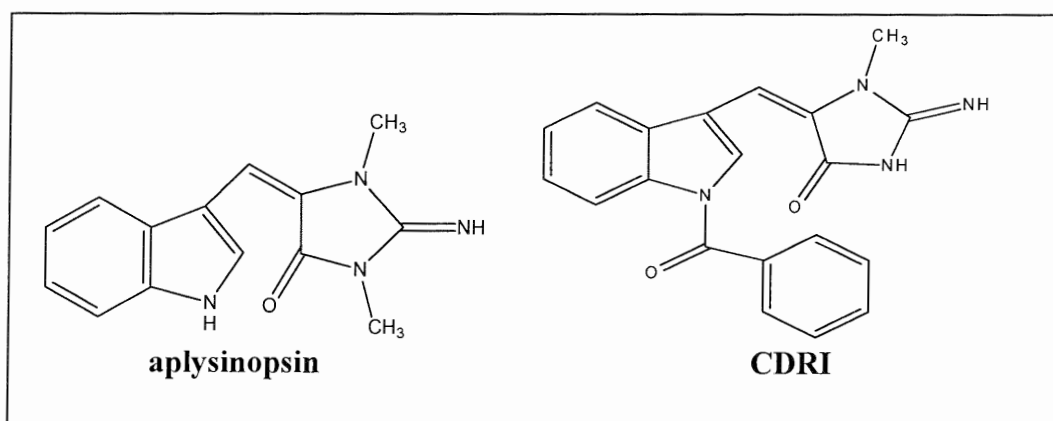

Fig. 4.2.1: Structure of aplysinopsin and CDRI compounds

Table 4.2.1: Results of cytotoxicity test of aplysinopsin and the brominated aplysinopsin

Name of compound	Growth inhibition in %		
	L5178Y 10µg/ml	HELA 10µg/ml	PC 12 10µg/ml
<i>E</i> -Aplysinopsin	100 %	56 %	45 %
6-Bromoaplysinopsin	100 %	77 %	27 %

4.2.2 Explanation of the *E/Z*-aplysinopsin photoisomerization

E-aplysinopsin [17] and *Z*-aplysinopsin [18] were isolated from the marine sponge *Fascaplysinopsis reticulata*. Comparison of $^1\text{H-NMR}$ data (see Table 3.3.3.B) showed that in case of *E*-aplysinopsin the location of the carboline group of the imidazole ring caused a large deshielding effect (*ca.* 1 ppm) of H-2.

Aplysinopsin (*E*) / (*Z*) [17] and [18] (see Figure 4.2.2) were also isolated from the sponge *Tubastraea sp.* (Marine lit. 2003) and they were synthesized as well by Guella (Guella *et al.*, 1988). It was noticed that the synthetic (*E*) / (*Z*) mixture undergoes photoisomerization in solution under either UV irradiation or merely under the conditions of laboratory daylight. So, it was interesting whether photoisomerization of aplysinopsin, as a non-destructive process for entrapping radiant energy, protects dendrophyliids and sponges exposed in shallow-water to sun burning irradiation. Thus, it could be concluded that the ratio of the (*E*) / (*Z*) stereoisomers of aplysinopsin in nature depends on the wave length of radiation that is filtered by the sea (Guella *et al.*, 1988).

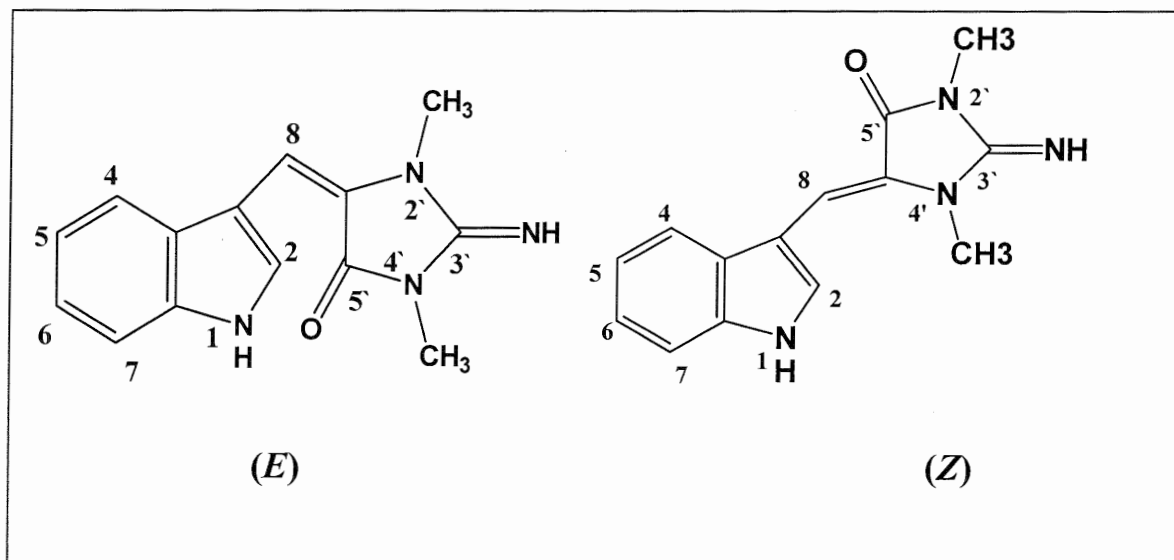

Figure 4.2.2: Structure of *E*-aplysinopsin [17] and *Z*-aplysinopsin [18]

4.3 β -Carboline alkaloids from marine animals

β -Carbolines are a class of indole alkaloids, biosynthetically derived from the amino acid L-tryptophan.

β -carboline was isolated from *Chrysophyllum lacourtianum*, *Nocardia* sp., *Catharanthus roseus* leaves, *Lolium perenne*, *Strychnos johnsonii*, *Strychnos potatorum* and *Festuca arundinacea*. It was also obtained from *Streptomyces* sp. and from the New Zealand ascidian *Ritterella sigillinoides* (Marine Lit. 2003).

Recently, it was reported that some β -carboline derivatives; 2-methyleudistomin D, 2-methyleudistomin J and 14-methyleudistomidin C (see Figure 4.3); isolated from the marine ascidian *Eudistoma gilboverde*, exhibited most potent cytotoxic activity, with IC_{50} s of $< 1.0 \mu\text{g/ml}$, against four different human tumor cell lines. The biosynthesis of complex β -carbolines is generally believed to involve the coupling of tryptophan with a second amino acid; this was confirmed by recent *in vivo* studies with *E. olivaceum* showing that tryptophan and proline are the primary precursors of eudistomin (Adams and Oxender, 1989)

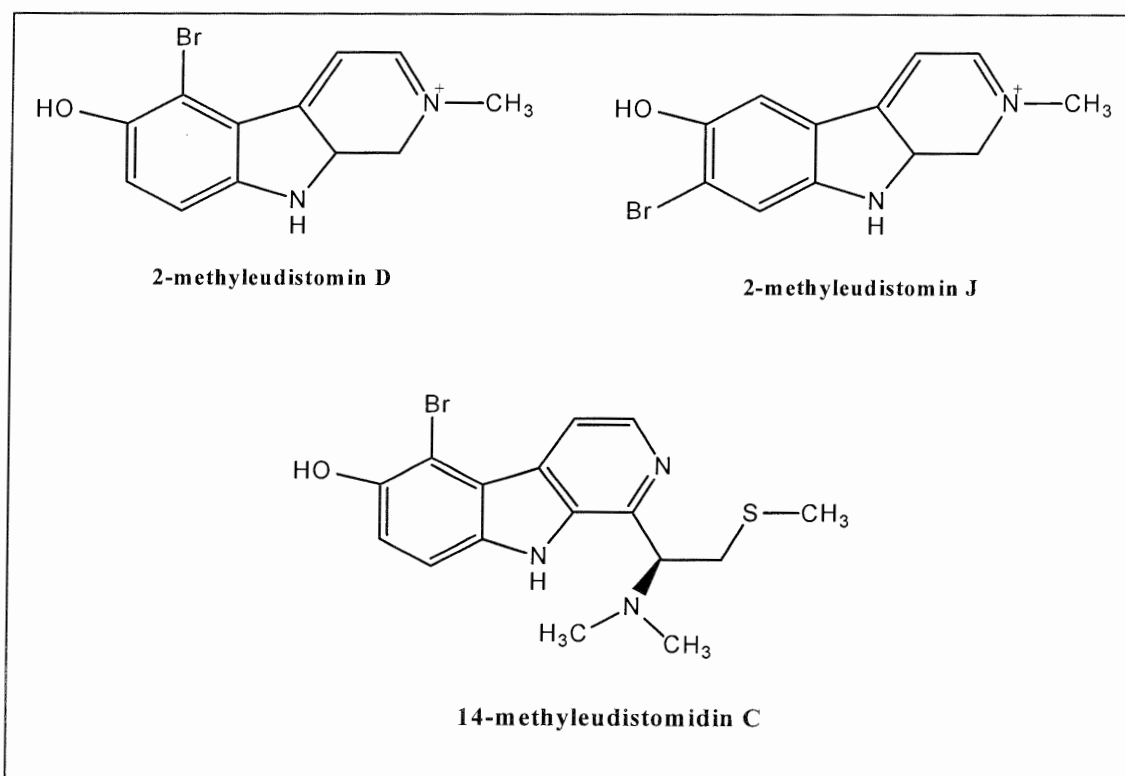

Figure 4.3: Some β -carboline derivatives

4.3.1 Structure-activity relationship of β -carbolines

The β -carbolines harman and harmaline (1-methyl-7-methoxy-3,4-dihydro- β -carboline) (see Figure 4.3.1) have been shown to exert multiple pharmacological effects, such as monoamine oxidase inhibition, convulsive or anticonvulsive action and anxiolytic effect. Thus, a possible role of β -carbolines in the pathophysiological processes that initiate Parkinson's disease was postulated. Their involvement in the pathogenesis of Parkinson's disease was due to structural similarity to the neurotoxin N-methyl-4-phenyl-1,2,3,6-tetrahydropyridine (MPTP). The chloral-derived β -carboline derivative [1-trichloromethyl-1,2,3,4-tetrahydro- β -carboline (TaClo)] caused cell loss in neuronal and glial cell cultures and induced a slowly developing neurodegenerative process in rats (Riederer *et al.* 2002). However, the toxic action of the compounds on neuronal cells has not been clearly elucidated. In contrast to this suggestion, some reports have indicated that β -carbolines show effective antioxidant abilities. Harman, harmaline and harmalol (3,4-dihydro-1-methyl-9H-pyrido[3,4-*b*]indol-7-ol) (see Figure 4.3.1) were found to inhibit enzymatically and nonenzymatically induced lipid peroxidation of liver microsomes and to attenuate oxidative damage of hyaluronic acid, cartilage collagen and IgG (Lee *et al.*, 2000).

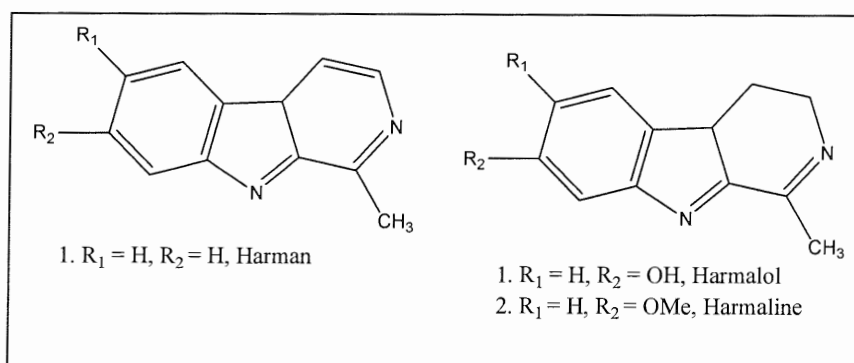

Figure 4.3.1: Structures of harman, harmaline and harmalol

4.4 Cyclic peptides isolated from the tunicate *Lissoclinum patella*

Naturally occurring cyclic peptides are becoming increasingly important due to their broad spectrum of pharmacological activities and interesting chemical structures, often containing novel or unusual amino acid residues. In particular, many examples of antiproliferative natural cyclic peptides have been lately reported, especially from marine sources. This suggests that, in principle, new anticancer agents, based on peptidic or peptidomimetic structures, may be developed (Janin *et al.*, 2003).

In this work five known cyclic peptides were isolated from the tunicate *Lissoclinum patella*; which was reported to contain other cyclic peptides that are characterized by the presence of heterocyclic thiazole and oxazoline rings such as ulicyclamide, ulithiacylamide, patellamides-A, patellamides-B, lissoclinamide-1, lissoclinamide-2, lissoclinamide-3, lissoclinamide-4, lissoclinamide-5, lissoclinamide-6, lissoclinamide-7, lissoclinamide-8 and prelissoclinamide-2 (see figure 4.4) (Sesin *et al.*, 1986 and Lindel *et al.*, 2000).

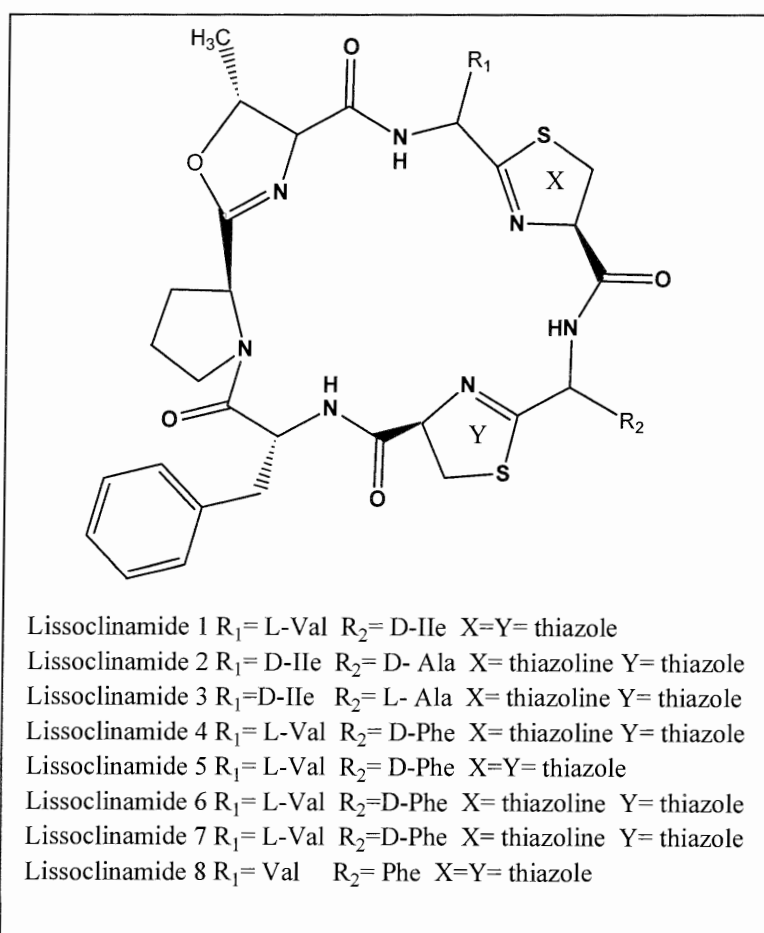

Figure 4.4: Metabolites from *Lissoclinum patella*

4.4.1 Metal binding to cyclic peptides

Cyclic peptides have been the subject of extensive investigation due to their involvement in metal binding and transport in biological systems. The interest in this field was the isolation of cyclic peptides from the ascidian *Lissoclinum patella* (Sea Squirt). Studies have demonstrated the ability of the patellamides to coordinate to metal ions such as calcium (II), copper (II) and zinc (II). A crystal structure of the dinuclear copper carbonato bridged complex demonstrated that the patellamides can bind two copper ions, each metal being coordinated to the peptide through a thiazole, an oxazoline and a deprotonated isoleucine amino acid (Ile) amide nitrogen, the coordination geometry of each copper being completed by a bridging carbonate anion and a water molecule (Grandahl *et al.*, 1999).

4.4.2 Structure-activity relationship of peptides

Cyclic peptides are a fascinating family of molecules that can function as antibiotics, toxins, ion-transport regulators, protein binding inhibitors, enzyme inhibitors and immunosuppressants (Gross *et al.*, 2002).

Cationic peptides are the largest group and the first to be reported; being widely distributed in animals and plants, cationic peptides can be divided into three different classes: (1) linear peptides forming-helical structures; (2) cysteine-rich open-ended peptides containing single or several disulfide bridges; and (3) molecules rich in amino acids such as proline, glycine, histidine and tryptophan. The mechanism of action of the cationic peptides is not satisfactorily established for all cationic peptides. However, the structural model set by Shai-Matzusaki-Huang provided a reasonable explanation for most antimicrobial activities of these compounds. The model proposed that these linear amphipatic-helical peptides increase the membrane permeability; either by the effect of their positive charges with anionic lipids displacements due to the drastic changes in the net charge of the composed system or the cysteine-rich peptides were suggested to form ion-permeable channels in the lipid bilayer (Marshall and Arenas, 2003).

5. Summary

Marine organisms such as sponges, tunicates and fungi have provided an amazing array of important biologically active compounds. Many of them showed potent activity against cancer cells and other diseases. Thus, an intense search for new and more effective agents has been conducted over the last 50 years in the aim of helping and solving human health problems and for a better understanding of the marine ecological system.

In the present study marine organisms including four sponges and one tunicate, collected from Red Sea (Jordan) and Indonesia, were investigated. Thirty one metabolites were isolated using different chromatographic techniques. The structures of the compounds were established on the basis of NMR spectroscopic and mass spectrometric data.

5.1 The Red Sea sponge *Stylissa carteri*

The sponge *Stylissa carteri* afforded eleven brominated alkaloids; including one new brominated alkaloid [4]. The most interesting compound was the already known [5] *Z*-hymenialdisin, which was reported as a potent inhibitor of mitogen-activated protein kinase kinase-1 (MEK-1) (Eder *et al.*, 1999).

5.2 The Indonesian sponge *Diacarnus megaspinorhabdosa*

The sponge *Diacarnus megaspinorhabdosa* was successively extracted with MeOH and acetone, respectively. The combined extracts were concentrated to dryness and partitioned between petroleum ether, EtOAc, *n*-BuOH and H₂O fractions respectively. EtOAc and *n*-BuOH fractions were subjected to normal phase column chromatography followed by semi-preparative HPLC to isolate five known compounds including two indole alkaloids and three nucleosides.

5.3. The Indonesian sponge *Fascaplysinopsis reticulata*

The sponge *Fascaplysinopsis reticulata* yielded six alkaloids belonging to the group of hydantoin (=imidazolidine-2,4-diones) derivatives including two new alkaloids [17] and [18]. The other metabolites from this sponge showed strong cytotoxicity against cancer cells (L518y, Hela and PC). These metabolites were reported to show significant biological activity against filarial parasites (Sing *et al.*, 1997).

5.4 The Indonesian tunicate *Lissoclinum patella*

The tunicate was extracted with MeOH and then with acetone and the solvent was evaporated under reduced pressure. The crude extracts were partitioned between H₂O and EtOAc. The EtOAc fraction was then subjected to VLC using a gradient system from 100% dichloromethane to 100% MeOH, to yield different fractions. One fraction was subjected to normal phase column chromatography followed by semi preparative HPLC to isolate five known cyclic peptides.

5.5 The Indonesian sponge *Hyrtios reticulatus*

The sponge was extracted with MeOH and acetone, the solvent was removed under reduced pressure. The EtOAc extract was then partitioned between H₂O and EtOAc. The ethyl acetate layer was subjected to VLC using a gradient system, from 100% dichloromethane to 100% MeOH to yield different fractions. One fraction was subjected to normal phase column chromatography followed by semi-preparative HPLC and preparative HPLC to isolate three alkaloid derivatives; including two new β -carboline **27** and **29** derivatives, with mild cytotoxicity against cancer cells (L518y).

6. References

Adams, M. and Oxender, D. (1989): *Journal of Biological Chemistry*, **264**, 15739-15742.

Annoura, H. and Tatsouka, T. (1995) *Tetrahedron Lett.*, **36**, 413-416.

Assmann, M. and Köck, M. (2002): *Z. Naturforsch.*, **57c**, 157-160.

Assmann, M.; Lichte, E.; Pawlik, J. R. and Köck, M. (2000): *Marine Ecology Progress Series*, **207**, 255-262.

Bergmann, W. and Burke, D. C. (1955): *J. Org. Chem.*, **20**, 1501-1507.

Bode, H. B. and Müller, R. (2003): *Plant Physiology*, **132**, 1153-1161.

Bourguet-Kondracki, M.; Martin, M.; Vacelet, J. and Guyot, M. (2001): *Tetrahedron Letters*, **42**, 7257-7259.

Bracher, F. and Hildebrand, D. (1993): *Pharmazie*, **48**, 695.

Brian, K. K.; Yarwood, D.; Sills, M. A.; Murphy, P. T; Hooper, J. N. A. and Wright, A. E. (2001): *J. Nat. Prod.*, **64**, 525-526.

Byoungcho, M.; Baker, B. J. and McClintock, J. B. (1998): *J. Nat. Prod.*, **61**, 116-118.

Capon R. J. and MacLeod, J. K. (1988): *Aus. J. Chem.*, **41**, 979-983.

Chehade, C. C.; Dias, R. L. A.; Berlinck, R. G. S.; Ferreira, A. G.; Costa, L. V.; Rangel, M.; Malpezzi, E. L. A.; De Freitas, J. C. and Hajdu, E.(1997): *J. Nat. Prod.*, **60**, 729-731.

Cimino, G.; De Rosa, S.; De Stefano, S.; Mazzarella, L.; Puliti, R. and Sodano, G. (1982): *Tetrahedron Lett.*, **23**, 767-768.

References

- Ebel, R.; Brenziger, M.; Kunze, A.; Gross, H. J. and Proksch, P. (1997): *J. Chem. Ecol.* **23**, 1451-1462.
- Eder, C. (1998): Isolierung und Strukturaufklärung biologisch aktiver Alkaloide aus marinen Schwammen Südostasiens, Doktorarbeit, Univ. Würzburg.
- Eder, C.; Proksch, P.; Wray, V.; Steube, K.; Bringmann, G.; Van Soest, R. W. M.; Sudarsono; Ferdinandus, E.; Pattisina, L. A.; Wiryowidagdo, S. and Moka, W. (1998): *J. Nat. Prod.*, **62**, 184-187.
- Eder, C.; Proksch, P.; Wray V.; Van Soest, W. M.; and Ferdinandus, E. (1999): *J. Nat. Prod.*, **62**, 1295-1297.
- El Sayed, K.; Hamann, M. T.; Hashish, N. E; Shier, T.; Kelly, M. and Khan, A. A. (2001): *J. Nat. Prod.*, **62**, 522-524.
- Engel, M. H; Serban, A. and Silfer, J, A. (1989): *J. Org. Chem.*, **54**, 3463-3472.
- Fu, X.; Do, T.; Schmitz, F.; Andrusevich, V. and Engel, M. H. (1998): *J. Nat. Prod.*, **64**, 1547-1551.
- Fattorusso, E.; Lanzotti, V.; Magno, S. and Novellino, E. (1985): *J. Nat. Prod.*, **64**, 924-927.
- Fujii, T.; Saito, T. and Mori, S. (1988): *Heterocycles*, **27**, 1145-1147.
- Faulkner, D. J. (1993): *Nat. Prod. Rep.*, **9**, 323-539.
- Faulkner, D. J. (2001): *Nat. Prod. Rep.*, **18**, 1-49.
- Fukada, N.; Trudell, M. L.; Johnson, B. and Cook, J. M. (1985): *Tetrahedron Letters*, **26**, 2139-2142.
- Garcia, E. E.; Benjamin, L. E.; and Fryer, R. I. (1973): *J. C. S. Chem. Comm.*, 78-79.

References

- Griebel, G.; Perrault, G.; Letang, V.; Avenet, P. and Sanger, S. D. (1999): *Psychopharmacology*, **146**, 205-213.
- Grandahl, L.; Gahan, L. R.; Fairlie, D. P.; Hanson, G. R.; Sokolenko, N. and Abbanante, G. (1999): *J. Chem. Soc.*, 1227-1234.
- Gross, J.; Cheng, Y.; Han, Q.; Zhou, J. and Gross, M. L. (2002): *50th ASMS conference on Mass Spectrometry and Allied Topics*.
- Gross, H, Kehraus S.; König G. M.; Woerheide G. and Wright A. D. (2002): *J. Nat. Prod.*, **65**, 1190-1193.
- Guella, G.; Mancini, I.; Zibrowius, H. and Pietra, F. (1988): *Helvetica Chimica acta*, **71**, 773-782.
- Hall, D. G. and Morton, T. H. (1980): *J. Am. Chem. Soc.*, **17**, 5689-5690.
- Higa, T.; Tanaka, J.; Ohtani, I. I.; Musman, M.; Roy, M. C. and Kuroda, I.(2001): *Pure Appl. Chem.*, **73**, 589-593.
- Hu, J.; Schetz, J. A.; Kelly, M.; Peng, J.; Ang, K. K. H.; Flotow, H.; Leong, C. Y.; Ng, S. B.; Buss, A. D.; Wilkins, S. P. and Hamann, M. T. (2002): *J. Nat. Prod.*, **62**, 476-480.
- Huwe, A.; Mazitscheke, R. and Giannis, A. (2003): *Angew. Chem. Int. Ed.*, **42**, 2122-2138.
- Inaba, k.; Sato, H.; Tsuda, M. and Kobayashi, J. (1998): *J. Nat. Prod.*, **62**, 693-695.
- Itaya, T.; Takada, Y. and Fujii, T. (1996): *Chem. Pharm. Bull.*, **44**, 2025-2032.
- Itaya, T.; Takada, Y.; Kanai, T. and Fujii, T. (1996): *Chem. Pharm. Bull.*, **44**, 2318-2321.
- Jakse, R.; Kroselj, V.; Recnik, S.; Sorsak, G.; Svete, J.; Stanovnik, B. and Grdadolnik, S. G. (2002): *Z. Naturforsch.*, **57b**, 453-459.

References

Janin, Y. L. (2003): *Amino acids*, **25**, 1-40

Jimenez, C.; Quinoa, E.; Adamczeski, M.; Hunter, L. M. and Crews, P. (1991): *J. Org. Chem.*, **56**, 3403-3410.

Kobayashi, J.; Ohizumi, Y.; Nakamura, H.; Hirata Y., Wakamatsu, K. and Miyazawa, T.(1986): *Experienta*, **42**, 1064-1065.

Kuo, S.; Lin, T.; Chang, S. S. and Wu, C. (1986): *J. Nat. Prod.*, **49**, 48-55.

Lee, C. S.; Han, E. S.; Jang, Y. Y.; Han, J. J; Ha, H. W. and Kim, D. E. (2000): *J. Neurochem.*, **75**, 521-531.

Lindsay, B. S.; Almeida, A. M. P.; Smith, C. J.; Berlinck, R. G. S.; Da Rocha, R. M. and Ireland, C. M. (1999): *J. Nat. Prod.*, **62**, 1573-1575.

Lindsay, B. S.; Battershill, C. N. and Copp, B. R. (1999): *J. Nat. Prod.*, **62**, 638-639.

Lindel, T., Hoffmann, H.; Hochgürtel, M. and Pawlik, J. R. (2000): *J. Chem. Ecol.*, **26**, 1477-1496.

Madyastha, K. M. and Sridhar, G. R. (1999): *J. Chem. Soc.*, 667-680.

Marshall, S. and Arenas, G. (2003): *Journal of Biotechnology*, **6**, 271-284.

Mayer, A. M. S. (1999): *The Pharmacologist*, **41**, 159-164.

Mayer, A. M. S. and Lehmann, V. K. B. (2000): *The Pharmacologist*, **42**, 62-69.

McDonald, L. A.; Foster, M. P.; Phillips, D. R. and Ireland, C. M. (1992): *J. Org. Chem.*, **57**, 4616-4624.

Meijer, L.; Thunnissen, A. M.; White, A. W.; Garnier, M.; Nikolic, M.; Tsai, L-H., Walter, J

References

- Cleverley, K.E.; Salinas, P. C.; Wu, Y-Z.; Biernat, J.; Mandelkow, E-M.; Kim, S-H. and Pettit, G.R. (2000) *Chemistry and Biology*, **1**, 51-64.
- Mitchell, S. S.; Whitehill, A. B.; Trapido-Rosenthal, H. G. and Ireland, C. M. (1997): *J. Nat. Prod.*, **60**, 727-728.
- Monniot, F. and Monniot, C. (2001): *Zoosystema*, **23**, 282-312.
- Morita, H.; Kayashita, T.; Takeya, K.; Itokawa, H. and Shiro, M. (1997): *Tetrahedron*, **53**, 1607-1616.
- Morris, L. A.; Van den Bosch, J. K.; Versluis, K.; Thompson, G. S. and Jaspars, M. (2000): *Tetrahedron*, **53**, 8345-8353.
- Nakamura, H.; Ohizumi, Y. and Kobayashi, J. (1998): *Tetrahedron Letters*, **25**, 2475-2478.
- Patil, A. D.; Freyer, A. J.; Killmer, L.; Myers, C. C. and Johnson, R. K. (1997): *Natural Product Letters*, **9**, 181-187.
- Van, P. K. (1996): *Annual Review of Microbiology*, **50**, 375-399.
- Pelttari, E.; Matikanien, J. and Elo, H. (2002): *Z. Naturforsch.*, **57c**, 548-552.
- Proksch, P.(1994): *Deutsche Apoth. Ztg.* **134**, 5069-5084
- Proksch, P.; Ebel, R. (1998): Ecological significance of alkaloids from marine invertebrates Alkaloids, Biochemistry, Ecology and Medicinal Application edited by Margaret F Roberts and Michael Wink, Plenum Publishing, 379-394.
- Proksch, P.; Edrada, R. A. and Ebel, R. (2002): *Appl. Microbial Biotechnol.*, **59**, 125-134.
- Rao, K. V.; Santarsiero, B. D.; Mesecar, A. D.; Schinazi, R. F.; Tekwani, B. L. and Hamann, M. T. (2003): *J. Nat. Prod.*, **66**, 823-828.

References

- Rashid, M. A.; Gustafson, K. R. and Boyd, M. R. (2001): *J. Nat. Prod.*, **64**, 1454-1456.
- Rinehart, K. L.; Gloer, J. B. and Cook, J.C. (1981): *J. Am. Chem. Soc.*, **103**, 1857-1859.
- Sakai, R.; Reinhart, K.; Kishore, V.; Kundu, B.; Faircloth, G.; Gloer, J.; Carney, J.; Namikoshi, M.; Sun, F.; Hughes, R. J.; Gravalos, G. D.; de Quesada, T.; Wilson, G. and Heid, R. (1996): *J. Med. Chem.*, **14**, 2819-2834.
- Salmoun, M.; Devijver, C.; Daloze, D.; Braekman, J. and Van-Soest, R. W. M. (2002): *J. Nat. Prod.*, **64**, 1173-1176
- Schmitz, F. J.; Gunasekera, S. P.; Lakshmi, V. and Tillekeratne (1985): *J. Nat. Prod.*, **48**, 47-53.
- Schmitz, F. J. in "Marine Natural Products" Ed. by P.J. Schreuer, 1978, vol.1, 198-241.
- Sesin, D. F.; Gaskell, S. J. and Ireland, C. M. (1986): *Bull. Soc. Chim. Belg.*, **95**, 853-867.
- Siddiqui, S.; Khan, O. Y.; Faizi, S. and Siddiqui, B. S. (1988): *Heterocycles*, **27**, 1401-1410.
- Singh, S. N.; Bhatnagar, S.; Fatma, N.; Chauhan, P. M. S. and Chatterjee, R. K. (1997): *Tropical Medicine and International Health*, **2**, 535-543.
- Sosa, A. C. B.; Yakushijin, K. and Horne, D. A. (2000): *J. Org. Chem.*, **63**, 610-611.
- Souleles, C. and Kokkalou, E. (1989): *Planta Medica*, **55**, 286-287.
- Sugiura, T.; Hamada, Y. and Shioiri, T. (1987): *Tetrahedron Letters*, **28**, 2251-2254.
- Supriyono, A. (1997) Biologisch aktive Naturstoffe aus tropischen Schwämmen Südostasiens, Doktorarbeit, Univ. Würzburg.
- Supriyono, A.; Schwarz, B.; Wray, V.; Witte L., Müller W. E. G., van Soest R., Sumanyono W. and Proksch, P. (1995): *Zeitschrift für Naturforschung*, 668-674.

References

Suzuki, H.; Iwata, C.; Sakurai, K.; Tokumoto, K.; Takahashi, H.; Hanada, M.; Yokoyama, Y. and Murakami, Y. (1997): *Tetrahedron*, **53**, 1593-1606.

Trudell, M. L.; Fukada, N. and Cook, J. M. (1987): *J. Org. Chem.*, **52**, 4293-4296.

Urdiales, J.; Morata, P.; De Castro, N. I. and Sanchez-Jimenez, F. (1996): *Cancer Lett.*, **102**, 31-37.

Wakade, A.; Guo, X.; Palmer, K.; Kulkarni, J.; Przywara, D. and Wakade, T. (1996): *Journal of Neurochemistry*, **67**, 2273-2281.

Williams, D. E. and Moore, R. E. (1989): *J. Nat. Prod.*, **52**, 732-739.

Xu, Y-Z.; Yakushijin, K. and Horne, D. A. (1996): *J. Org. Chem.*, **62**, 456-464.

Youssef, D.T.A.; Yoshida, W.Y.; Kelly, M. and Scheuer, P. J. (2001): *J. Nat. Prod.*, **64**, 1332-1335.

List of Abbreviations

$[\alpha]_D$: specific rotation at the sodium D-line
br	: broad signal
COSY	: correlation spectroscopy
d	: doublet
dd	: double of doublet
ddd	: double double of doublet
DEPT	: distortionless enhancement by polarization transfer
ED	: effective dose
EI	: electron impact
ESI	: electro spray ionization
eV	: electronvolt
FAB	: fast atom bombardment
HMBC	: heteronuclear multiple bond connectivity
HMQC	: heteronuclear multiple quantum coherence
HPLC	: high performance liquid chromatography
Hz	: Herz
LC	: lethal concentration
m	: multiplett
MeOD	: deuterated methanol
MeOH	: methanol
mg	: milligram
mL	: millilitre
MPLC	: medium pressure liquid chromatography
MS	: mass spectroscopy
m/z	: mass per charge
μg	: microgram
μL	: microliter
nm	: nanometer
NMR	: nuclear magnetic resonance
ppm	: part per million
Prep. HPLC	: preparative HPLC
q	: quartet

ROESY	: rotating frame overhauser enhancement spectroscopy
RP-18	: reversed phase C-18
s	: singlett
t	: triplett
TFA	: trifluoroacetic acid
TLC	: thin layer chromatography
UV	: ultra-violet
VLC	: vacuum liquid chromatography